

# Intelligent Scanner

Professional Lighting Technology

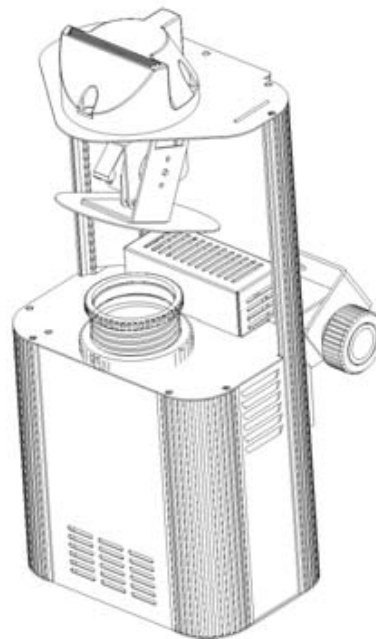
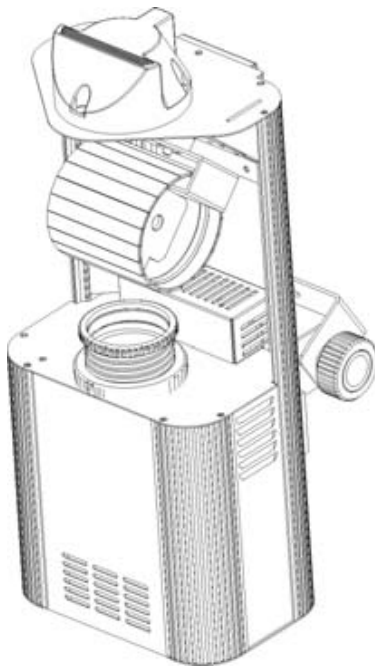

## User Guide

---

Please read the instructions carefully before use

# **INDEX**

## **A. GENERAL INSTRUCTIONS**

## **B. MAIN FEATURES**

## **C. LAMP**

## **D. HOW TO CONTROL THE UNIT**

- (1) By universal DMX controller
- (2) Preprogrammed function
- (3) By easy controller

## **E. FIXTURE CLEANING**

# A. GENERAL INSTRUCTIONS



Please read the enclosed instructions carefully as they include important points about safety for the installation, usage and maintenance of the unit.

## WARNING

- Please keep this booklet with the unit for future consultation. If you sell the unit to another user, be sure that the new user also receives this instruction booklet thus giving them the necessary information about the use and general warnings regarding the unit.
- Before the initial start-up, please unpack and carefully check all components in case any damage may have occurred during shipping.
- Locate a suitable spot for your device where there is good ventilation. Also, make sure that no ventilating fans or slots are blocked.
- Protect our environment! Please dispose of the packing boxes properly.
- The electrical work that is necessary for installation must be done by qualified personnel.
- Always remember to unplug the unit from the main power before any service is done. Do not open the unit. There are no serviceable parts inside.
- It is very important to ground the yellow/green conductor to earth in order to meet regulations for safety.
- Check the surrounding area and make sure there are no flammable liquids, water or metal objects that could enter the fixture. If a foreign object enters the unit, immediately disconnect the main power. Also, place the fixture in a well-ventilated room at about 15 cm from the walls.
- Do not touch any wires during operation, as high voltage is hazardous.
- In the event of serious operating problems, stop using the unit immediately. Never try to repair the unit yourself. Repairs carried out by unqualified personnel can lead to damage or malfunction. Please contact the nearest authorized Technical Assistance Center. Always use genuine spare parts.

## B. MAIN FEATURES

- The unit is a DMX512 scanner. It features full DMX512 control, 10 gobos/colors plus open and white, focus adjustable accurate optics system and stepper motor with blackout feature. Fan cooled.
- It can be operated by DMX512 control or can be used as an individual unit without controller.
- It can be linked together as many as required in master/slave mode, and perform the great built-in programmed lighting shows triggered by music.
- Please use a 3 pin XLR cable/plug when connecting them together.
- It features different pre-programmed chase patterns.

## C. LAMP

- Always switch off the mains supply and never handle the lamp or luminaire when it is hot.
- Do not touch the bulb with bare hands. If this does happen, clean the lamp with denatured alcohol and wipe with a lint free cloth before installing.

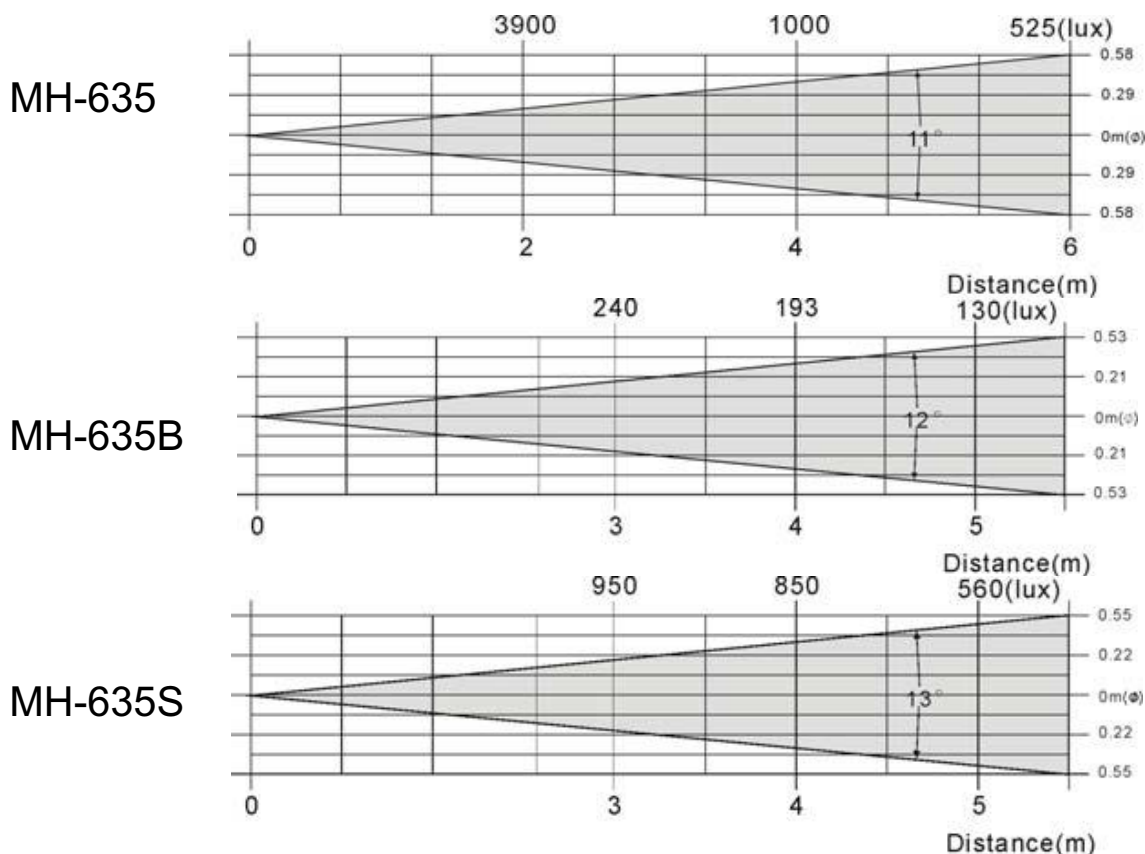

# D. HOW TO CONTROL THE UNIT

## ( 1 ) By universal DMX controller

The DMX512 is widely used in intelligent lighting control, with a maximum of 512 channels.

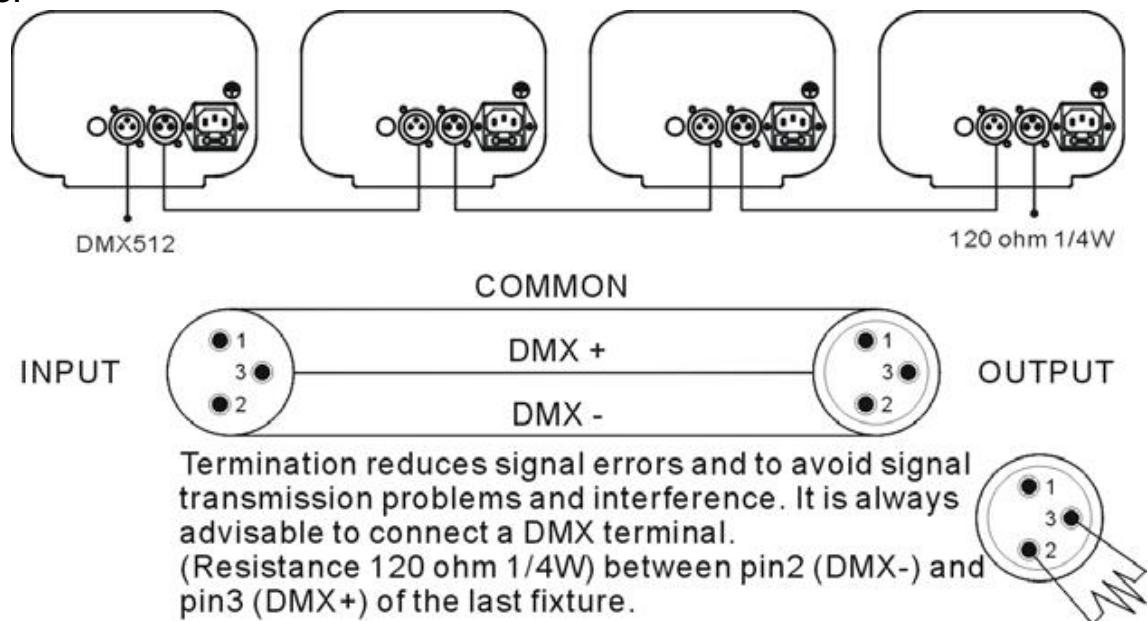

- ☒ A DMX512 system requires a controller, lighting equipment and cable. These are connected together in a “daisy chain” with the terminator at the end. The cable cannot be branched or split to a “Y” cable.
- ☒ The terminator requires a 90-120 Ohm 1/4 Watt resistor soldered between two signal cables.
- ☒ The DMX512 uses a very high-speed signal. Inadequate or damaged cables, bad solder joints or corroded connectors can easily distort the signal and shut down the system. A reliable DMX512 system starts with good quality cables.
- ☒ Each lighting unit needs to have an address set to receive the data sent by the controller. The address number is between 0-511. The end of the DMX512 system should be terminated reducing signal errors.
- ☒ 3 pin XLR connectors are more popular than 5 pin XLR.
  - 3 pin XLR: Pin 1: GND, Pin 2: Negative signal (-), Pin 3: Positive signal (+)
  - 5 pin XLR: Pin 1: GND, Pin 2: Negative signal (-), Pin 3: Positive signal (+)

## ( 2 ) Preprogram functions

The unit can be linked together in daisy chain as many as you need in master/slave mode to perform the great built-in pre-programmed lighting shows triggered by music.

### In Master/Slave mode refer to the DMX settings below:

**Master unit: DMX start address MUST be set to 001. (first DIP switch = ON, all other are OFF)**

**Slave units: DMX start address may have any value but NOT 001 (example: set the first 3 DIP switches to ON)**

\* 2-light show

Dipswitch 10 "off" means the unit works normally and "on" means inversion. In order to create a great light show, you can set dip switch 10 "on" on any unit that is linking to the master unit to get contrast movement to the master unit, even if you have two units only. Dipswitch 10 on the first ( Master ) unit is no use for the 2-light show as it is the master unit that operates the light show.





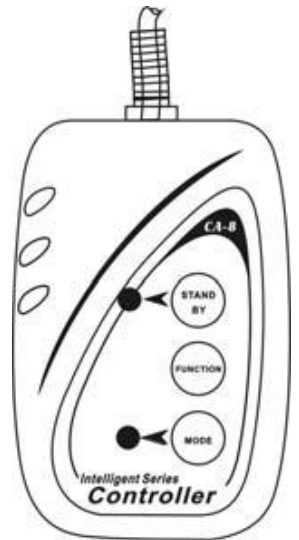

















## ( 3 ) By easy controller

The easy remote control is used only in master/slave mode. By connecting to the 1/4" microphone jack of the first unit (its DMX input plug is not used), you will find that the remote control on the first unit will control all the other units for Stand by, Function and Mode.



Built-in lighting shows triggered by Easy Controller:

Stand by	Blackout the unit		
Function	Strobe 1. sync. strobe 2. two-light strobe	X/Y moving pattern selection (12 patterns)	Color/Gobo selection
Mode	Strobe/ Sound (LED off)	Pattern/ Sound (LED blinking)	Sound (LED on)

DMX512 CONFIGURATION							
CHANNEL 1		CHANNEL 2		CHANNEL 3		CHANNEL 4	
PAN		TILT		SHUTTER		GOBO	
				248-255 Open		255 Fastest speed Gobo change	
				132-247 shaking		128 Slowest speed Gobo change	
				131 Fastest speed shutter		117-127 White	
						105-116 Blue+Magenta	
						094-104 Red	
						082-093 Magenta	
						070-081 Red+Yellow+Green+Blue	
						059-069 Pink	
						047-058 Green	
						035-046 Blue+Red+Green	
						024-034 Blue	
						012-023 Yellow	
						000-011 White	
				008-015 Open			
				16 Slowest speed shutter			
				000-007 Blackout			

- Start the address

How to address your DMX512 system:

1. Select the channels of DMX controller
2. Dipswitches

Dip	#1	#2	#3	#4	#5	#6	#7	#8	#9
Value	1	2	4	8	16	32	64	128	256

- Examples:

Channel 01: dip / on : #1 (=1)

Channel 05: dip / on : #1, #3 (1+4=5)

Channel 09: dip / on : #1,#4 (1+8=9)

Channel 13: dip / on : #1,#3,#4 (1+4+8=13)

## E. FIXTURE CLEANING

The cleaning of internal and external optical lenses and/or mirrors must be carried out periodically to optimize light output. Cleaning frequency depends on the environment in which the fixture operates: damp, smoky or particularly dirty surroundings can cause greater accumulation of dirt on the unit's optics.

- ☒ Clean with a soft cloth using normal glass cleaning products.
- ☒ Always dry the parts carefully.
- ☒ Clean the external optics at least once every 20 days. Clean the internal optics at least every 30/60 days.

### **EC Declaration of Conformity**

We declare that our products (lighting equipments) comply with the following specification and bears CE mark in accordance with the provision of the Electromagnetic Compatibility (EMC) Directive 89/336/EEC.

EN55014-2: 1997 A1:2001, EN61000-4-2: 1995; EN61000-4-3:2002;  
EN61000-4-4: 1995; EN61000-4-5: 1995, EN61000-4-6:1996,  
EN61000-4-11: 1994.

&

### **Harmonized Standard**

EN60598-1: 2000+ALL:2000+A12:2002

Safety of household and similar electrical appliances

Part 1 : General requirements



## Technical Specifications

	MH-635	MH-635B	MH-635S
Power	AC 120V 50 / 60Hz AC 230 250V 50Hz	AC 120V 60Hz AC 230 250V 50Hz	AC 120V 60Hz AC 230 250V 50Hz
Fuse	T5A T3.15A	T6.3A T5A	T6.3A T5A
Lamps	EFP 12V 100W	ELC 24V 250W	ELC 24V 250W
Dimension	385x170x122mm	405x170x122mm	385x170x122mm
Weight	3.8kg	4.5kg	4.5kg

Широкий ассортимент оборудования АСМЕ  
на [www.maxlight.ru](http://www.maxlight.ru)

=====  
For further requirements, contact the nearest authorized technical assistance office  
=====