

iSolution

Your integrated Solution

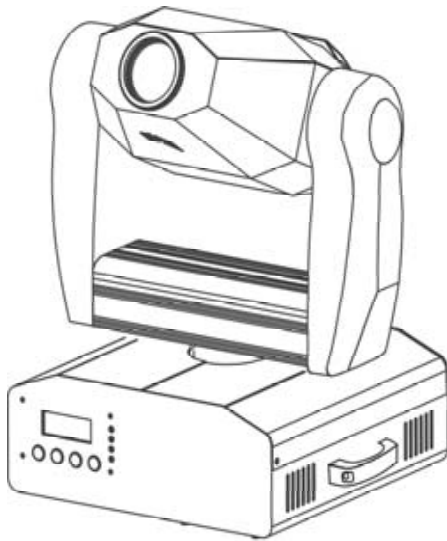

IM-5S-ELC

IM-5S-HID

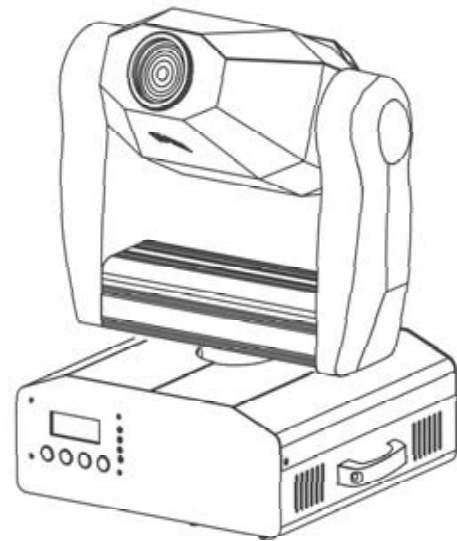

IM-5W-ELC

IM-5W-HID

User Guide

Professional Entertainment Technology

TABLE OF CONTENTS

1. Safety Instruction
2. Technical Specification
 - 2.1 Beam Angel
3. Lamp
4. How To Set The Unit
 - 4.1 Control Panel
 - 4.2 Main Function
5. How To Control The Unit
 - 5.1 Master/Slave Built-In Preprogrammed Function.
 - 5.2 Easy Controller
 - 5.3 iSolution Operation / Universal DMX Controller
 - 5.4 DMX 512 Configuration
 - 5.5 DMX 512 Connection
6. Troubleshooting
7. Fixture Cleaning

Широкий ассортимент оборудования АСМЕ
на www.maxlight.ru

1. Safety Instruction



WARNING

Please read carefully the instruction, which includes important information about the installation, usage and maintenance.

- ☒ Please keep this User Guide for future consultation. If you sell the unit to another user, be sure that they also receive this instruction booklet.
- ☒ Unpack and check carefully there is no transportation damage before using the unit.
- ☒ Before operating, ensure that the voltage and frequency of power supply match the power requirements of the unit.
- ☒ The unit is designed for use with the HID 150W or ELC 24V 250W (two version). Do not use any other type of lamp.
- ☒ It's important to ground the yellow/green conductor to earth in order to avoid electric shock.
- ☒ The unit is for indoor use only. Use only in a dry location.
- ☒ The unit must be installed in a location with adequate ventilation, at least 50cm from adjacent surfaces. Be sure that no ventilation slots are blocked.
- ☒ Disconnect main power before fuse/lamp replacement or servicing.
- ☒ Replace fuse/lamp only with the same type.
- ☒ Make sure there is no flammable materials close to the unit while operating as it is fire hazard.
- ☒ Use safety cable when fixes this unit. Don't handle the unit by taking its head only, but always by taking its base.
- ☒ Maximum ambient temperature is TA: 40°C. Don't operate it where the temperature is higher than this.
- ☒ Unit surface temperature may reach up to 85°C. Don't touch the housing bare-hand during its operation. Turn off the power and allow about 15 minutes for the unit to cool down before replacing bulb or serving.
- ☒ In the event of serious operating problem, stop using the unit immediately. Never try to repair the unit by yourself. Repairs carried out by unskilled people can lead to damage or malfunction. Please contact the nearest authorized technical assistance center. Always use the same type spare parts.
- ☒ Don't connect the device to any dimmer pack or power pack.
- ☒ Do not touch any wire during operation as high voltage might be causing electric shock.

Warning

- ☒ To prevent or reduce the risk of electrical shock or fire, do not expose the unit to rain or moisture.
- ☒ Never touch bulb with bare fingers as it is very hot after using.
- ☒ Hot lamp explosion hazard. Do not open the unit within five minutes after switching off.
- ☒ Do not start on the unit without bulb enclosure or housing are damaged.
- ☒ The housing, the lenses, or the ultraviolet filter must be replaced if they are visibly damaged.
- ☒ Do not look directly at the light while the bulb is on.

Caution

There are no user serviceable parts inside the unit. Do not open the housing or attempt any repairs yourself. In the unlikely event your unit may require service, please contact your nearest dealer.

Installation

The unit should be mounted via its screw holes on the bracket. Always ensure that the unit is firmly fixed to avoid vibration and slipping while operating. Always ensure that the structure to which you are attaching the unit is secure and is able to support a weight of 20 kgs for each unit.

2. Technical Specification

- Voltage: AC 120V~60Hz or 230V/240V/250V~50/60Hz
- Bulb: HID 150W
ELC 24V 250W
- The unit is DMX 512 fixture. It features full DMX 512 control. It can be also linked together in master/slave connection, as many as required and run by built-in program chase sequences automatically or by sound activation through an internal microphone to create an intelligent effect.
- It can be operated by DMX 512 control or can be used as an individual unit without a controller.
- Consistent DMX channel enable iRock, iShow and iMove to be link together.
- Features different preprogrammed chase patterns.
- Please use a 3 pin XLR cable/plug when connecting units together.
- Accurate focusable optics system and ultra smooth stepping motors. Fan cooled.
- Pan : 540 deg. Tilt : 270 deg.
- Dimension : 290 x 330 x 380 mm
- Weight : 12 kg

Move Spot Independent gobo wheel with 14 gobos plus open and blackout, including 11 metal, 2 glass and 1 effect gobos with shaking and shutter effect, Independent color wheel with 11 dichroic colors with rainbow effect.

Move Wash Independent color wheel with 11 dichroic colors with rainbow effect and independent shutter & dimmer.

2.1 Beam Angle

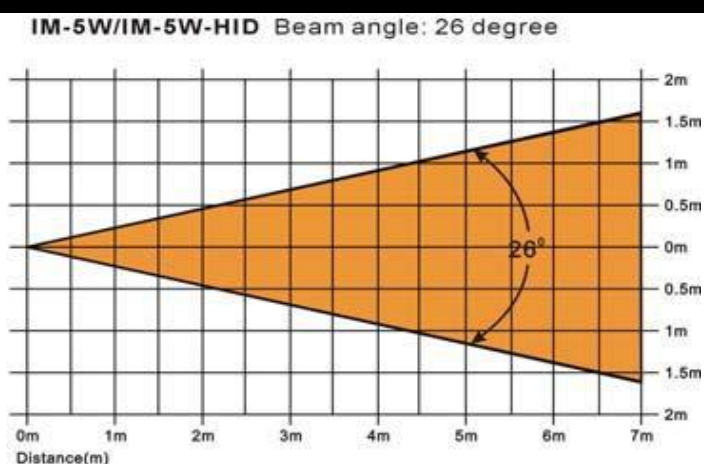
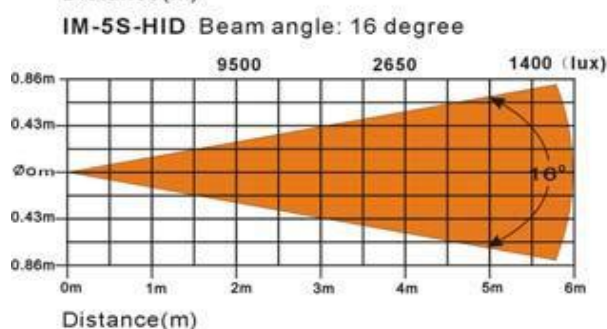
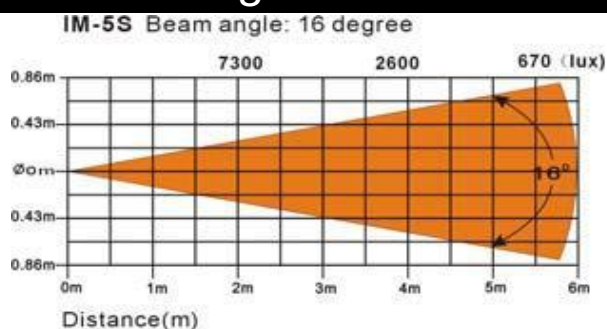

3. Lamp



In case of replacement of the lamp or maintenance, do not open the fixture within 15 minutes until the unit cools down after switching off.

Lamp :

HID 150W

ELC 24V 250W

1. Always switch off the main supply and never handle the lamp or luminaries when is hot.
2. Do not touch the bulb with bare hands. If this happens, clean the lamp with denatured alcohol and wipe it with a lint free cloth before installation.
3. Never operate the lamp without appropriate shielding.
4. Make sure the lamp is located in the center for the best spot.

Diagram for Lamp changing

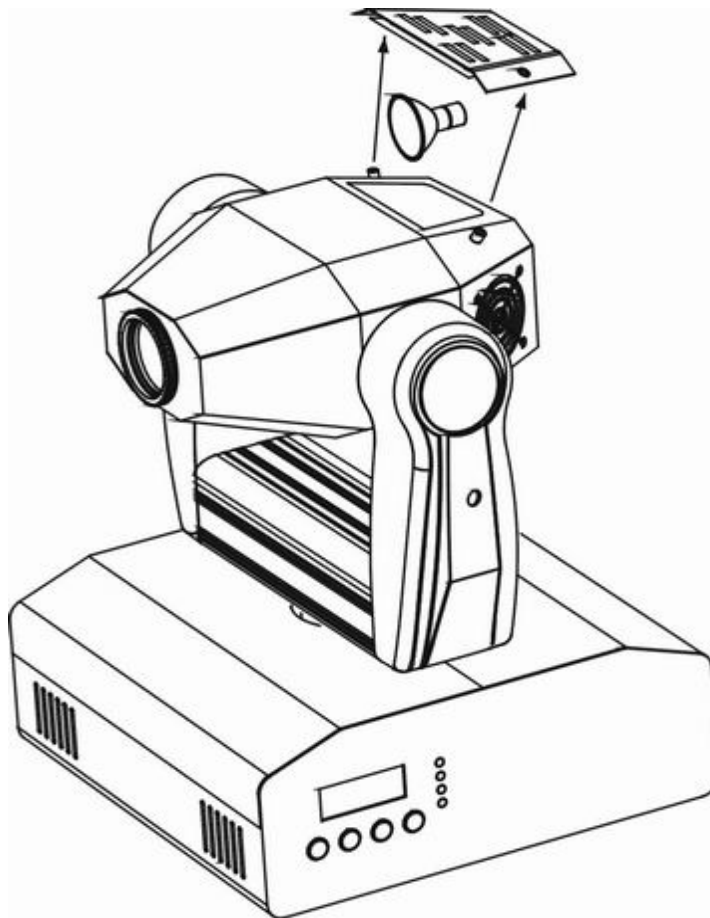

HID 150W Lamp Installation Or Replacement

- Always switch power off before installing or replacing the lamp. Never try to replace the lamp when it is hot.
- Do not touch the bulb with bare hands. Cleaning the lamp with denatured alcohol and wipe with a lint free cloth when lamp is dirty.

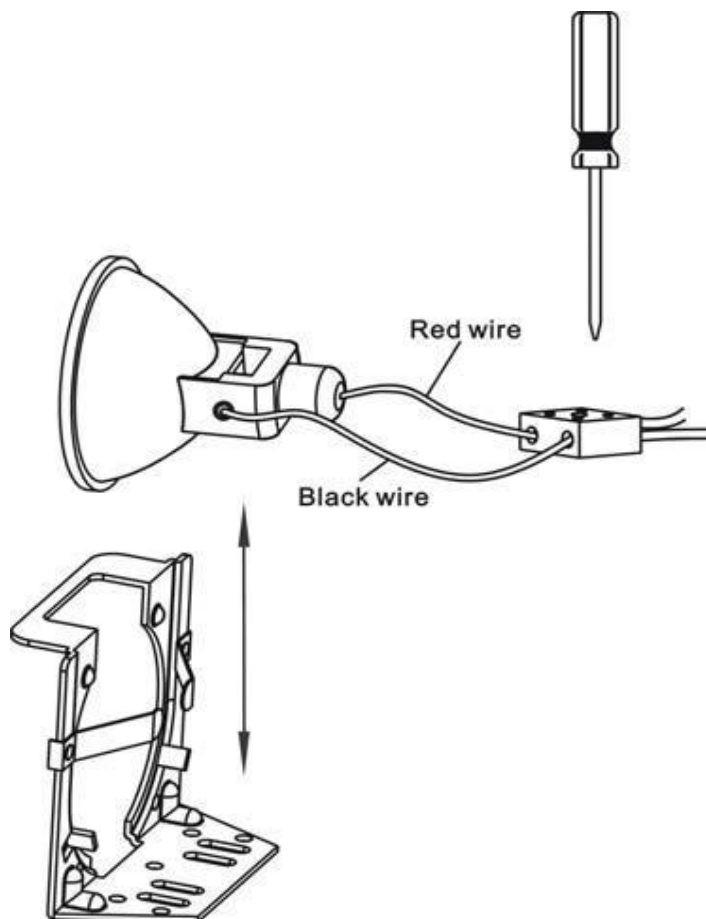

1. Loosen the screw on the housing cover.
2. Loosen the screws of the lamp wire from the terminator.
3. Remove the old lamp from the fixture.
4. Please be careful to install the lamp into the case, make sure it wedges tightly so that it cannot move easily. **WARNING:** Improper installation will cause the lamp's lifespan to shorten and may cause an explosion during operation.
5. Connect the lamp wire to the terminator as before.
6. Please reinstall step 2 and step 1.

4. How To Set The Unit

4.1 Control Panel

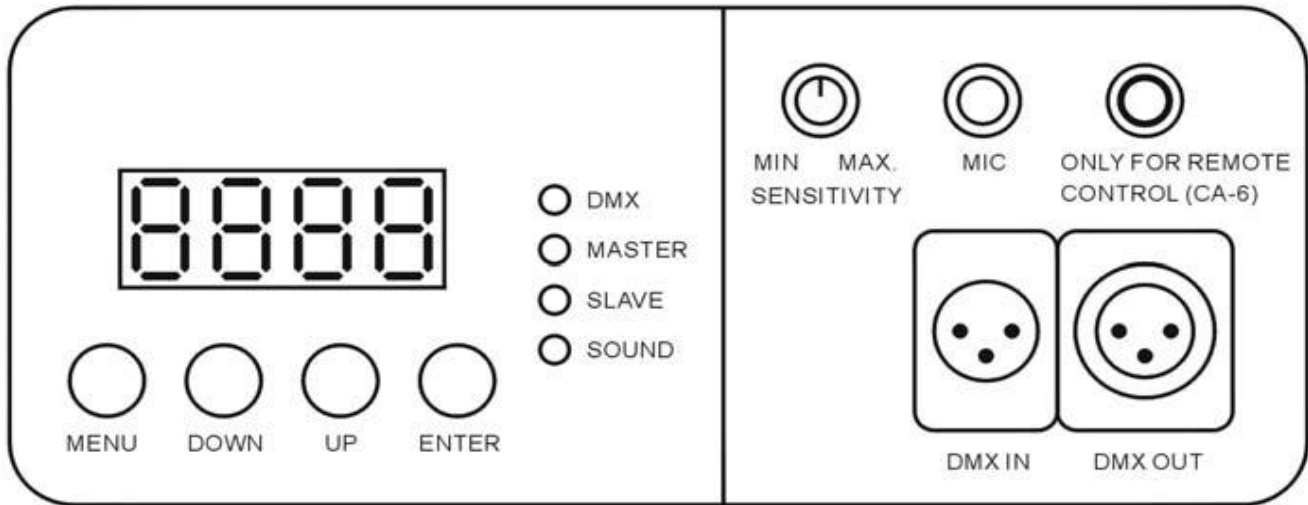

Display

To show the various menus and the selected functions.

LED

DMX	On	DMX input present
MASTER	On	Master Mode
SLAVE	On	Slave Mode
SOUND	Flashing	Sound activation

Button

MENU	To select the programming functions
DOWN	To go backward in the selected functions
UP	To go forward in the selected functions
ENTER	To confirm the selected functions

Remote controller input

By connect to the 1/4" microphone jack to control the unit for stand by, function and mode

Sensitivity

To adjust the sound sensitivity.

Microphone

To receive audio signal for sound activation.

DMX input/output

For DMX512 link, use 3-pin XLR plug cable to link the unit together.

4.2 Main Function

To select any of the given functions, press the **MENU** button up to when the required one is showing on the display. Select the function by **ENTER** button and the display will blink. Use **DOWN** and **UP** button to change the mode. Once the required mode has been selected, press the **ENTER** button to setup or it will automatically return to the main functions without any change after idling 8 seconds. To go back to the functions without any change press the **MENU** button. The main functions are showing below:

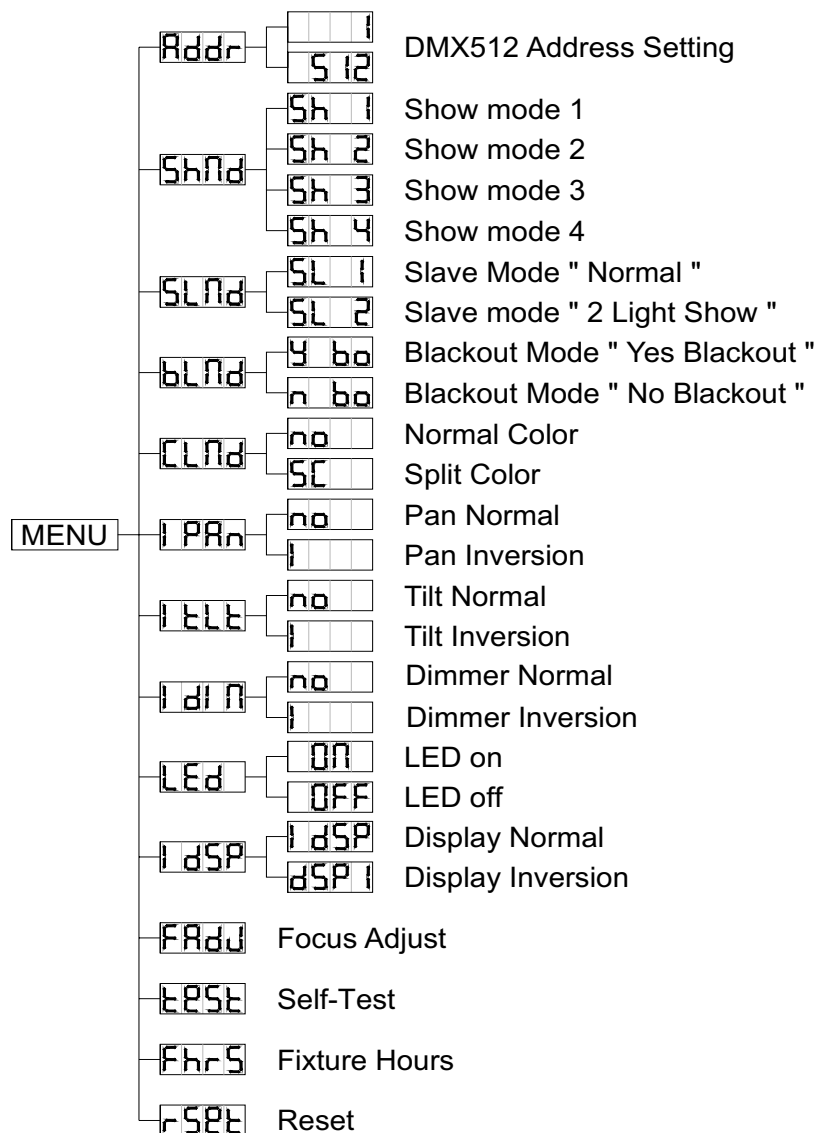

Addr DMX 512 Address Setting

Press the **MENU** button up to when the **Addr** is showing on the display. Pressing **ENTER** button and the display will blink. Use **DOWN** and **UP** button to change the DMX512 address. Once the address has been selected, press the **ENTER** button to setup or automatically return to the main functions without any change after 8 seconds. To go back to the functions without any change press the **MENU** button again.

SHNd

Show Mode

Press the **MENU** button up to when the **SHNd** is showing on the display. Pressing **ENTER** button and the display will blink. Use **DOWN** and **UP** button to select the **SH 1** (show 1) or **SH 2** (show 2) or **SH 3** (show 3) or **SH 4** (show 4) mode. Once the mode has been selected, press the **ENTER** button to setup or automatically return to the main functions without any change after 8 seconds. To go back to the functions without any change press the **MENU** button again.

SH 1

Show 1 mode - Fixture is placed on the floor. Tilt movement angle 210°.

SH 2

Show 2 mode - Fixture is fixed under ceiling. Tilt movement angle 90°.

SH 3

Show 3 mode - Fixture is placed on the speaker, The spot is always projecting to the audience's direction; i.e in front of the stage. Pan movement angel (left to right to left): 160°. Tilt movement angel: 90° (60° above horizon; 30° below horizon.)

SH 4

Show 4 mode - Fixture is fixed under ceiling. The spot is mainly projecting in front of the stage. Pan movement angel (left to right to left) :160°. Tilt movement angel: 90° (vertically, front 75°; back 15°)

SLNd

Slave Mode

Press the **MENU** button up to when the **SLNd** is showing on the display. Pressing **ENTER** button and the display will blink. Use **DOWN** and **UP** button to select the **SL 1** (normal) or **SL 2** (2 light show) mode. Once the mode has been selected, press the **ENTER** button to setup or automatically return to the main functions without any change after 8 seconds. To go back to the functions without any change press the **MENU** button again.

BLNd



Blackout Mode

Press the **MENU** button up to when the **BLNd** is showing on the display. Pressing **ENTER** button and the display will blink. Use **DOWN** and **UP** button to select the **y bo** (yes blackout) or **n bo** (no blackout) mode. Once the mode has been selected, press the **ENTER** button to setup or automatically return to the main functions without any change after 8 seconds. To go back to the functions without any change press the **MENU** button again.

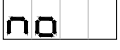
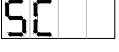

Color Mode

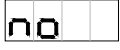
Press the **MENU** button up to when the  is showing on the display. Pressing **ENTER** button and the display will blink. Use **DOWN** and **UP** button to select the  (normal) or  (split color) mode. Once the mode has been selected, press the **ENTER** button to setup or automatically return to the main functions without any change after 8 seconds. To go back to the functions without any change press the **MENU** button again.

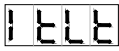
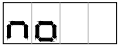

Pan Inversion

Press the **MENU** button up to when the  is showing on the display. Pressing **ENTER** button and the display will blink. Use **DOWN** and **UP** button to select the  (normal) or  (pan inversion) mode. Once the mode has been selected, press the **ENTER** button to setup or automatically return to the main functions without any change after 8 seconds. To go back to the functions without any change press the **MENU** button again.

Tilt Inversion

Press the **MENU** button up to when the  is showing on the display. Pressing **ENTER** button and the display will blink. Use **DOWN** and **UP** button to select the  (normal) or  (tilt inversion) mode. Once the mode has been selected, press the **ENTER** button to setup or automatically return to the main functions without any change after 8 seconds. To go back to the functions without any change press the **MENU** button again.

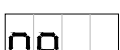
Dimmer Inversion

Press the **MENU** button up to when the  is shown on the display. Pressing **ENTER** button and the display will blink. Use **DOWN** and **UP** button to select the  (normal) or  (dimmer inversion) mode. Once the mode has been selected, press the **ENTER** button to setup or automatically return to the main functions without any change after 8 seconds. To go back to the functions without any change press the **MENU** button again.

Led Display

Press the **MENU** button up to when the  is showing on the display. Pressing

ENTER button and the display will blink. Use **DOWN** and **UP** button to select the **ON** (Led on) or **OFF** (Led off) mode. Once the mode has been selected, press the **ENTER** button to setup or automatically return to the main functions without any change after 8 seconds. To go back to the functions without any change press the **MENU** button again.

LDSP Display Inversion

It is good for you to install the unit on the floor or under ceiling. Press the **MENU** button up to when the **LDSP** is blinking on the display. Use the **ENTER** button to change to the mode **dSPi** (display inversion), It will automatically store after 8 seconds. Or press the **ENTER** button again return to the mode **LDSP** (display normal). To go back to the functions press the **MENU** button again.

LDSP Display normal mode for the fixture putting on the floor.

dSPi Display inversion mode for the fixture fixing under ceiling.

FRdU Focus Adjust

Press the **MENU** button up to when the **FRdU** is blinking on the display. Pressing **ENTER** button, the unit will focus on tilt 90°, and then the unit will focus on pan 0°, pan 90°, pan180°, pan270° in every pressing **ENTER** button. To go back to the functions press the **MENU** button again.

TEST Self-Test

Press the **MENU** button up to when the **TEST** is blinking on the display. Pressing **ENTER** button and the unit will run self-test by built in program. To go back to the functions press the **MENU** button again.

Fhrs Fixture Hours

Press the **MENU** button up to when the **Fhrs** is blinking on the display. Pressing **ENTER** button and the display will show the number of working hours of the unit. To go back to the functions press the **MENU** button again.

rSet Reset

Press the **MENU** button up to when the **rSet** is blinking on the display. Pressing **ENTER** button and all channels of the unit will return to their standard position. To go back to the functions without any change press the **MENU** button again.

5. How To Control The Unit

You can operate the unit in three ways:

1. By master/slave built-in preprogram function
2. By easy controller
3. By iLead controller (please refer to the user guide of iLead) or universal DMX controller

No need to turn the unit off when you change the DMX address, as new DMX address setting will be effected at once. Every time you turn the unit on, it will show IM-5S/IM-5W on the display and move all the motors to their 'home' position and you may hear some noises for about 20 seconds. After that the unit will be ready to receive DMX signal or run the built in programs.

5.1 Master/Slave Built In Preprogrammed Function

By linking the units in master/slave connection, the first unit will control the other units to give an automatic, sound activated, synchronized light show. This function is good when you want an instant show. You have to set the first unit in master mode **SHnd** and select **SH 1** (show 1) or **SH 2** (show 2) or **SH 3** (show 3) or **SH 4** (show 4) mode. Its DMX input jack will have nothing plugged into it, and its master LED will be constantly on and sound LED will flash to the music. The other units will have to set in slave mode **SLnd** and select **SL 1** (normal) or **SL 2** (2 light show) mode, Their DMX cables plugged into the DMX input jacks (daisy chain) and the slave led lights will constantly on.

2-light show

In **SLnd** (slave mode), **SL 1** means the unit works normally and **SL 2** means 2-light show. In order to create a great light show, you can set **SL 2** on the second unit to get contrast movement to each other, even if you have two units only.

5.2 Easy Controller

The easy remote control is used only in master/slave mode. By connecting to the 1/4" microphone jack of the first unit, you will find that the remote control on the first unit will control all the other units functions press the **MENU** button again.



Move Spot	Stand by	Blackout the unit			
	Function	Strobe 1.Gobo / Color sync. strobe 2.Sync. strobe 3.Two-light strobe	X/Y moving show mode selection (Show 1 ~ Show 4) Please refer to Show mode in 4.2 Main Function	Color/Gobo selection 1. Hold on for gobo change. 2. Press shortly for color change	X/Y moving setting 1.Pan position 2.Tilt position First set Master unit, then set Slave units' position
	Mode	Sound 1 (LED off)	Sound 2 (LED normal blinking)	Slow/Sound 3 (LED on)	Position/ Latch (LED fast blinking)
Move Wash	Stand by	Blackout the unit			
	Function	Strobe 1.Color sync. strobe 2.Sync. strobe 3.Two-light strobe	X/Y moving show mode selection (Show 1 ~ Show 4) Please refer to Show mode in 4.2 Main Function	Color selection	X/Y moving setting 1.Pan position 2.Tilt position 3.Dimmer First set Master unit, then set Slave units' position
	Mode	Sound 1 (LED off)	Sound 2 (LED normal blinking)	Slow/Sound 3 (LED on)	Position/ Latch (LED fast blinking)

5.3.1 iSolution Operation

- ◆ Consistent DMX configuration enable iMove to be linked together with iRock and iShow and controlled at the same time.
- ◆ DMX address can be set remotely by iLead controller (please refer to the user manual of iLead controller). No need to calculate the DMX channels of each fixture in the chain.
- ◆ Automatic switching between DMX function and built-in stand alone programs.

5.3.2 DMX Controller

An universal DMX controller to control the units, you have to set DMX address from 1 to 512 channel so that the units can receive DMX signal.

Press the **MENU** button up to when the **Addr** is showing on the display. Pressing **ENTER** button and the display will blink. Use **DOWN** and **UP** button to change the DMX512 address.











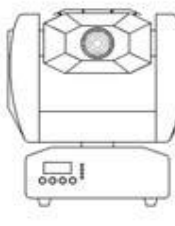

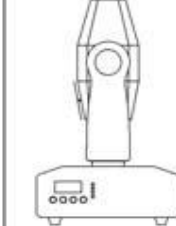













Once the address has been selected, press and keep **ENTER** button pressed up to when the display stops blinking or storing automatically 8 seconds later. To go back to the functions without any change press the **MENU** button again. If you use please refer to the following diagram to address your DMX512 channel for the first 4 units.

DMX address can be setting remotely by IL-0824 controller. No need to calculate the DMX channels of each fixture in the chain.



5.4 DMX 512 Configuration

Item	Ch 1	Ch 2	Ch 3	Ch 4	Ch 5	Ch 6	Ch 7
Move Spot	Pan	Tilt	Shutter/Sharking	Gobo	Color		
Move Wash	Pan	Tilt	Shutter	No function	Color	No function	Dimmer

DMX512 Configuration			
Ch1	Ch2	Ch3	Ch4
Pan	Tilt	Shutter/Sharking	Gobo
540°    0°	270°    0°	248-255 Open 247 Fastest speed Shaking   132 Slowest speed shaking 131 Fastest speed shutter   16 Slowest speed shutter 008-015 Open 000-007 Blackout	255 Fastest speed Gobo change  128 Slowest speed Gobo change 120-127  111-119  103-110  094-102  086-093  077-085  069-076  060-068  052-059  044-051  035-043  026-034  018-025  009-017  000-008 
Ch5		Ch6	Ch7
Normal	Color	No function	Dimmer
255 Fastest speed Rainbow effect  128 Slowest speed Rainbow effect 118-127 Pink 107-117 Yellow 096-106 Orange 086-095 Light Green 075-085 UV Purple 064-074 Blue 054-063 Red 043-053 Amber 032-042 Light Blue 022-031 Magenta 011-021 Green 000-010 White	255 Fastest speed Rainbow effect  128 Slowest speed Rainbow effect 121-127 Pink 113-120 Yellow+Pink 106-112 Yellow 098-105 Orange+Yellow 091-097 Orange 083-090 Light Green+Orange 076-082 Light Green 068-075 UV Purple 061-067 Blue 053-060 Red+Blue 046-052 Red 038-045 Amber 031-037 Light Blue 023-030 Magenta 016-022 Green+Magenta 008-015 Green 000-007 White		100%  0

5.5 DMX512 Connection

The DMX 512 is widely used in intelligent lighting control, with a maximum of 512 channels.

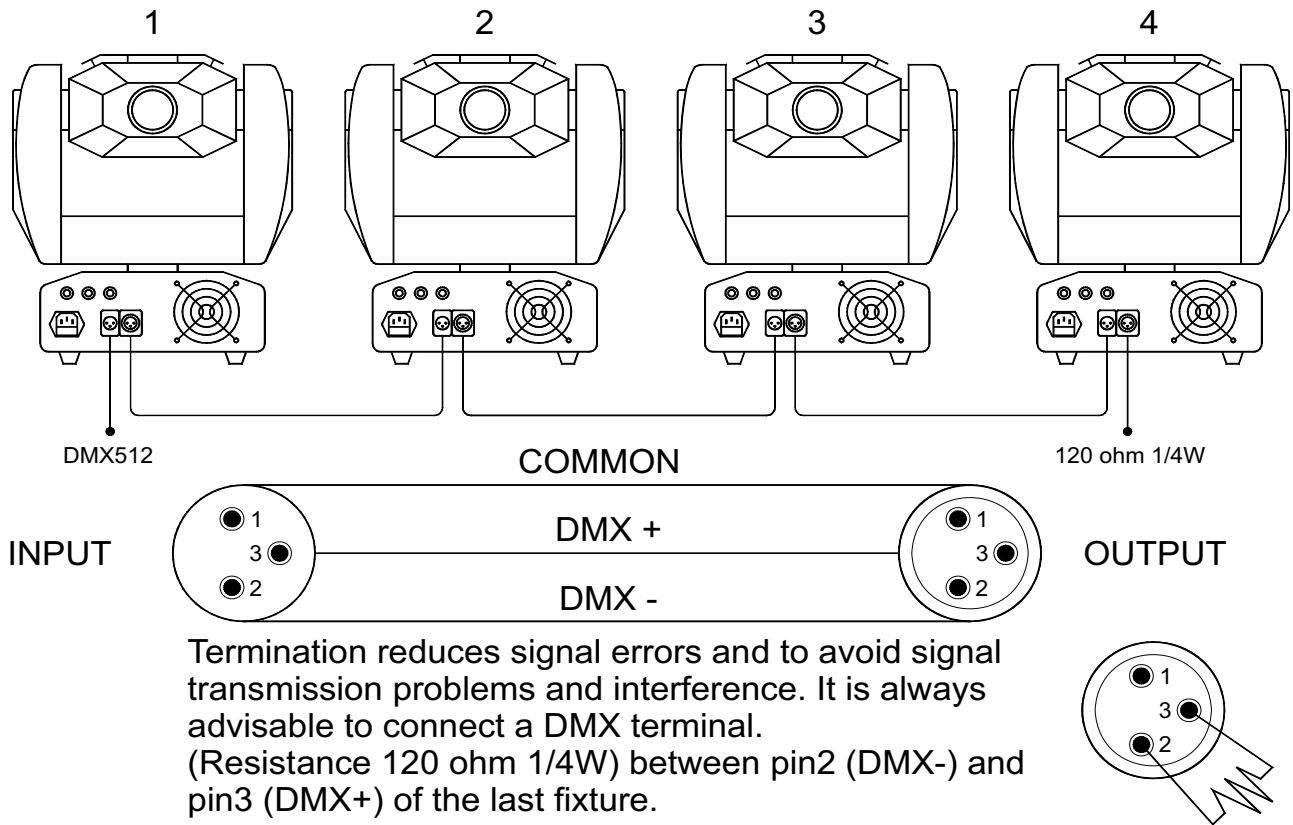

1. If you using a controller with 5 pins DMX output, you need to use a 5 to 3 pin adapter-cable.
2. At last unit, the DMX cable has to be terminated with a terminator. Solder a 120 ohm 1/4W resistor between pin 2(DMX-) and pin 3(DMX+) into a 3-pin XLR-plug and plug it in the DMX-output of the last unit.
3. Connect the unit together in a `daisy chain` by XLR plug from the output of the unit to the input of the next unit. The cable can not branched or split to a `Y` cable. DMX 512 is a very high-speed signal. Inadequate or damaged cables, soldered joints or corroded connectors can easily distort the signal and shut down the system.
4. The DMX output and input connectors are pass-through to maintain the DMX circuit, when power is disconnected to the unit.
5. Each lighting unit needs to have an address set to receive the data sent by the controller. The address number is between 0-511 (usually 0 & 1 are equal to 1).
6. The end of the DMX 512 system should be terminated to reduce signal errors.
7. 3 pin XLR connectors are more popular than 5 pin XLR.
 - 3 pin XLR: Pin 1: GND, Pin 2: Negative signal (-), Pin 3: Positive signal (+)
 - 5 pin XLR: Pin 1: GND, Pin 2: Negative signal (-), Pin 3: Positive signal (+)

6. Troubleshooting

Following are a few common problems that may occur during operation. Here are some suggestions for easy troubleshooting:

A. The unit does not work, no light and the fan does not work

1. Check the connection of power and main fuse.
2. Measure the mains voltage on the main connector.
3. Check the power on LED.

B. Not responding to DMX controller

1. DMX LED should be on. If not, check DMX connectors, cables to see if link properly.
2. If the DMX LED is on and no response to the channel, check the address settings and DMX polarity.
3. If you have intermittent DMX signal problems, check the pins on connectors or on PCB of the unit or the previous one.
4. Try to use another DMX controller.
5. Check if the DMX cables run near or run alongside to high voltage cables that may cause damage or interference to DMX interface circuit.

C. Some units don't respond to the easy controller

1. You may have a break in the DMX cabling. Check the LED for the response of the master/ slave mode signal.
2. Wrong DMX address in the unit. Set the proper address.

D. No response to the sound

1. Make sure the unit does not receive DMX signal.
2. Check microphone to see if it is good by tapping the microphone

E. One of the channels is not working well

1. The stepper motor might be damaged or the cable connected to the PCB is broken.
2. The motor's drive IC on the PCB might be out of condition.

F. The lamp is cutting out intermittently

1. The lamp is not working well. Check the main voltage either too high or too low.
2. Internal temperature may be too high. Check and if necessary replace the fan on the head.

G. If The pan belt is broken

1. Turn off the main power.
2. Unscrew all the screws (A) and open the base-housing cover (B).
3. Unplug all the connect wires (C) that from the arm to PC board and ignitor.
4. Unscrew the screws (D) that fix the axis gear (E).
5. Change a new belt (F) by going through all connect wires that from the arm to base, and through the bridge for correct position.
6. Set up the gear axis to the bridge and screwed it. Note : do not press the belt.
7. Put the belt around the axis gear and motor gear.
8. Plug all the connect wires (C) that form the arm to PC board and ignitor.
9. Adjust the pan home position.
10. Screw the base-housing cover (B).

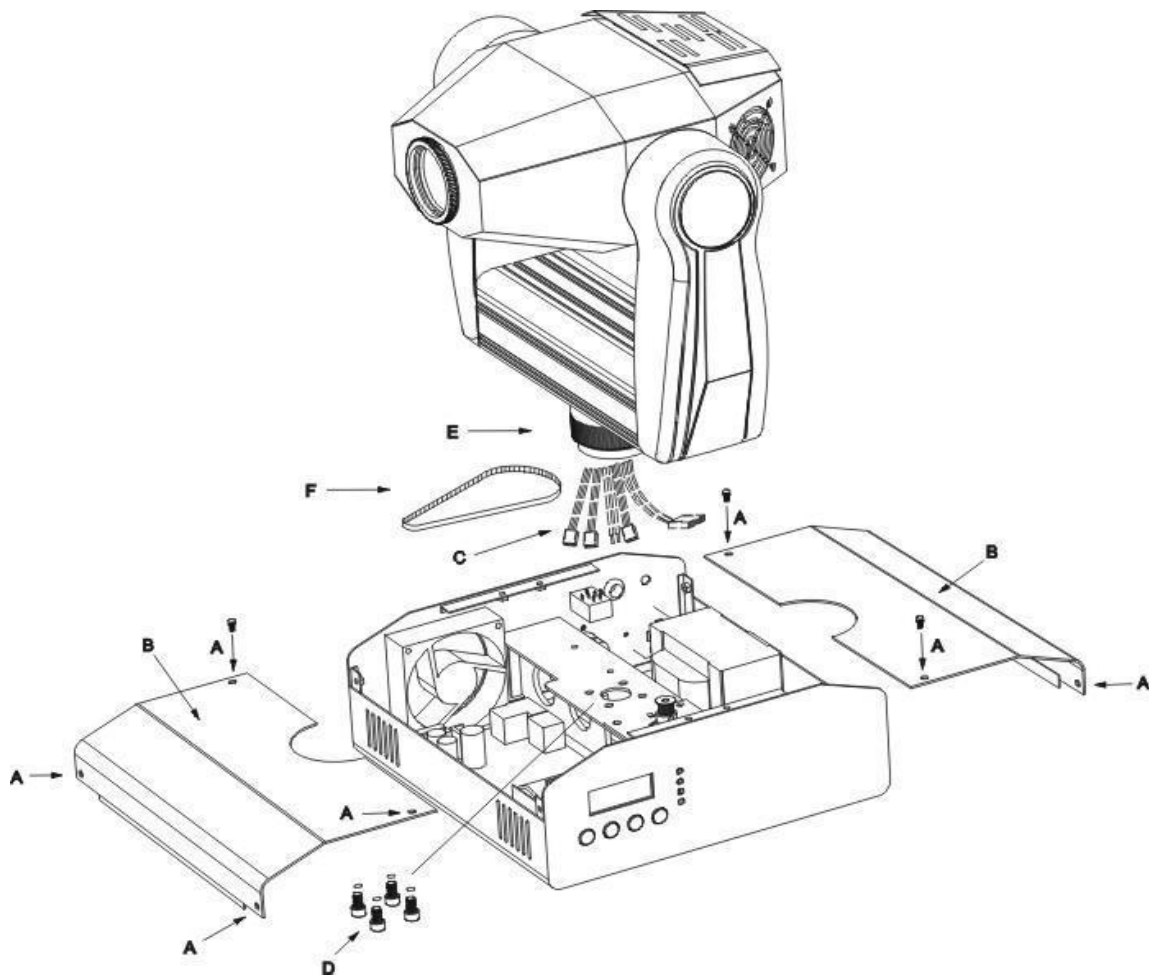

7. Fixture Cleaning

The cleaning of internal and external optical lenses and/or mirrors must be carried out periodically to optimize light output. Cleaning frequency depends on the environment in which the fixture operates: damp, smoky or particularly dirty surrounding can cause greater accumulation of dirt on the unit's optics.

- ☒ Clean with soft cloth using normal glass cleaning fluid.
- ☒ Always dry the parts carefully.
- ☒ Clean the external optics at least every 20 days. Clean the internal optics at least every 30/60 days.
- ☒

EC Declaration of Conformity

We declare that our products (lighting equipments) comply with the following specification and bears CE mark in accordance with the provision of the Electromagnetic Compatibility (EMC) Directive 89/336/EEC.

EN55014-2: 1997 A1:2001, EN61000-4-2: 1995; EN61000-4-3:2002;
EN61000-4-4: 1995; EN61000-4-5: 1995, EN61000-4-6:1996,
EN61000-4-11: 1994.

&

Harmonized Standard

EN60598-1: 2000+ALL:2000+A12:2002

Safety of household and similar electrical appliances

Part 1 : General requirements

Technical Specifications

Power	AC 120V~60Hz	AC 230/240/250V~50/60Hz
Fuse	20mm Glass T6.3A Fast Blow	20mm Glass T5A Fast Blow
Lamp	HID 150W ELC 24V 250W	
Dimension	290 x 330 x 380 mm	
Weight	12 kg	

Innovation , Quality , Performance