

ALLEN & HEATH



AR2412 AudioRack

The **AR2412** is an audio interface rack for the Allen & Heath GLD and Qu digital mixing systems. It provides 24 remote controlled mic/line preamps and 12 XLR line outputs. It connects to the mixer over a single Cat5 cable using the Allen & Heath dSNAKE protocol. An AR84 or AB168 AudioRack can be connected to the AR2412 to expand the number of system inputs and outputs. A dedicated Monitor port allows connection to Allen & Heath ME personal mixing system.

The AR2412 is simply an audio interface. It cannot be used by itself. It must connect to the GLD or Qu mixer which is where the audio is processed.

- The AR2412 is not compatible with Allen & Heath iLive Series components or ACE connection.

Refer to the GLD User Guide AP8561 and Qu User Guide AP9372 for instructions on connecting and using the AR2412 with your system. Refer to the Allen & Heath web site for more information and suitable Cat5 cables.

The diagrams below show two example applications.

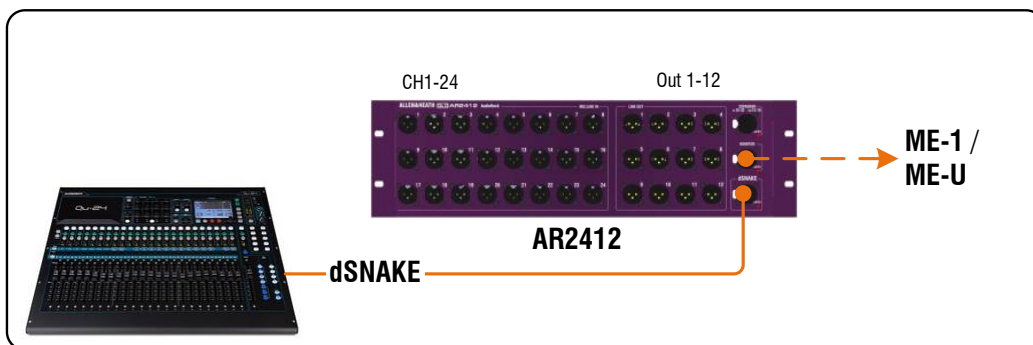

Qu-24 + AR2412

Access all 24 mic inputs on stage

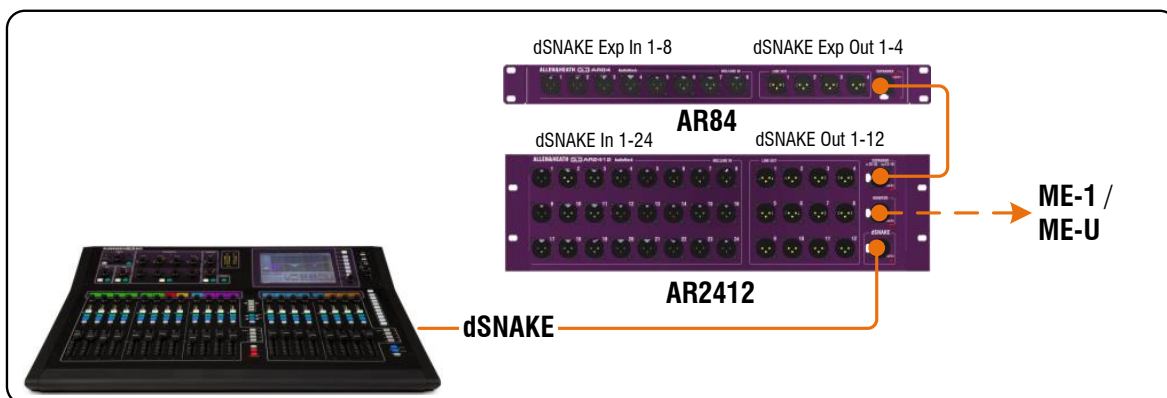

GLD-80 + AR2412 + AR84

Expanded GLD system, 40 in, 26 out

Allen & Heath can provide the following CAT5e cables:

- AH9650** 100m drum of Etherflex cable with Neutrik EtherCon locking connectors.
- AH9651** 20m Etherflex cable with Neutrik EtherCon locking connectors.

AR2412 Panel Layout



① Input sockets 24 balanced XLR inputs for microphone and line level sources. The preamps are built into the AR2412 rack and their Gain, Pad and 48V phantom power is remote controlled from the mixer via the dSNAKE link. The output of the analogue preamps are converted to digital format and transported via dSNAKE to be processed and mixed at the GLD or Qu mixer.

The sockets are numbered 1-24. On GLD, any input can be patched to any channel at the console. On Qu, sockets are mapped one-to-one to input channels.

② Output sockets 12 balanced XLR outputs operating at nominal +4dBu line level. Any signal can be patched to any socket using the GLD I/O screen or Qu **Setup / Output Patch / dSNAKE** menu. The mixer defaults to a logical mapping of these sockets to get you started.

③ EXPANDER port Cat5 cable link to connect an AR84 or AB168 rack to add further mic/line inputs and XLR line outputs. The GLD system numbers these sockets as dSNAKE Exp Inputs 1-16.

④ MONITOR port Cat5 cable link to connect to Allen & Heath ME personal mixing system. With a GLD system, the port is also compatible with Aviom™ A-16 personal mixers.

⑤ dSNAKE port Cat5 cable link to connect the AR2412 rack to the mixer. This carries the inputs, outputs and the monitor port sends audio to and from the rack as well as control for the preamps and system status.

Maximum Cat5 cable length is 120m (396') depending on cable type.

- Note that dSNAKE is not compatible with the iLive ACE connection.



⑥ Fan A low noise fan ensures air movement through the rack to keep the circuits within operating temperature range.

- Ensure good ventilation at the back of the rack.

⑦ Mains power input IEC connector, fuse and power ON/OFF push switch for the built-in universal voltage power supply unit. This accepts worldwide voltages from 100 to 240V AC 50/60Hz. Check that you have received the correct mains lead for your territory.

Secure the cable in place using the plastic P-clip. Use a T20 Torx screwdriver to refit the screw.

- Read the Safety Instructions Sheet and information printed on the panel before operating.

GLD-AR2412 WEIGHTS AND MEASURES

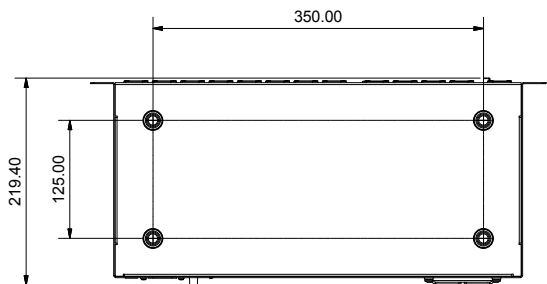
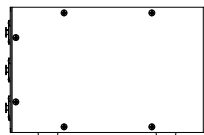
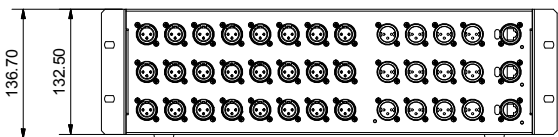
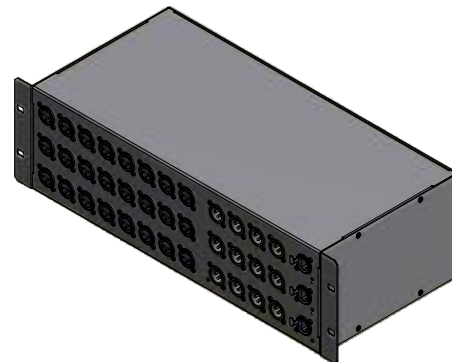
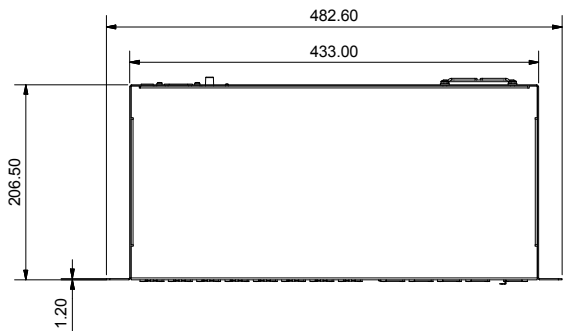

GLD AR2412 - without box

Width 482.6mm (19")
 Depth 219.4mm (8.6")
 Height 136.7mm (5.4")
 Weight 5kg (11lbs)

GLD AR2412 - including box

Width 595mm (23.4")
 Depth 342mm (13.5")
 Height 250mm (9.8")
 Weight 6.4kg (14.1lbs)

DO NOT USE FOR PRODUCTION!

REVISION HISTORY

REV	DESCRIPTION	DATE	APPROVED
A	ORIGIN	21/10/2011	ALEXMO

THIRD ANGLE PROJECTION

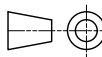

MATERIAL:

All materials to be compliant with The Restriction of Hazardous Substances (ROHS) Directive (2002/95/EC)

TOLERANCES U.O.S:
 GENERAL ± 0.25 HOLE CENTRES ± 0.10
 HOLE SIZES ± 0.05 ANGULAR DIMS ± 0.50°

FINISH:

DRAWING

MAIN ASSY GLD-AR2412

UNIT GLD

PART No 004-195

ALLEN & HEATH Ltd.

KERNICK INDUSTRIAL ESTATE
 PENRYN CORNWALL TR10 9LU
 TELEPHONE 01326 372070
 FACSIMILE 01326 370153

DRAWING No

Weights and measures GLD-AR-2412

SHEET

ISSUE

1 of 1 A

6. Connecting dSNAKE Remote Audio

The Qu mixer provides local sockets on its rear panel for all audio inputs and outputs. It can also work with remote audio by connecting over a single cable 'digital snake' to an Allen & Heath AudioRack, or to the Allen & Heath ME Personal Mixing System.

6.1 Connecting to a remote AudioRack

The Qu can connect to an Allen & Heath AudioRack so that the audio can be plugged into a rack on stage and routed to the mixer over a single Cat5 cable 'digital snake' plugged into its dSNAKE port.



dSNAKE carries:

- Up to 38 remote input signals
- Up to 16 remote output signals
- 40 personal mixing sends
- Preamp control – Gain, Pad, 48V

The 'digital snake' – dSNAKE provides a convenient, single Cat5 cable alternative to the typical heavy analogue copper multicore to connect many inputs and outputs on stage. One cable carries multiple channels of audio in both directions together with remote control of the preamps.

Cat5 cable – Use STP (shielded twisted pair) Cat5e or higher cables. Those with both foil and braided screens provide shielding from interference and are generally more rugged. Stranded core cables are less prone to damage when kinked or repeatedly coiled.



The Qu mixer provides a locking Neutrik EtherCon socket to protect the connections and ensure suitability for touring. Use a touring grade cable fitted with locking EtherCon plugs.

Maximum cable length = 120m (396') depending on cable type. Recommended maximum length = 100m (330').

Remote Inputs - dSNAKE inputs are mapped one-to-one to the Qu input channels. They are not patchable.

i dSNAKE does not add channels to the mixer. Choose either Local (rear panel) or dSNK (remote) input for each channel.

Remote Outputs - Qu outputs can be patched to the output sockets on the remote racks. These duplicate the outputs on the Qu rear panel.



Connecting Qu to the AudioRack – Plug one end of your Cat5 'digital snake' into the Qu mixer dSNAKE port. Plug the other end into the dSNAKE port of the AudioRack.

Connecting a second AudioRack – The AR2412 and AB168 AudioRacks include an EXPANDER port. You can use this to connect to an AR84 or AB168 AudioRack.

i The AR2412 AudioRack cannot be used as an expander in a Qu system.

i You can connect up to two AudioRacks in a Qu system. This includes the main rack and one expander rack.

Once connected and powered up, the Qu touch screen should display the 'dS' icon in its toolbar to show that one or more dSNAKE devices are recognised by the system.



6.2 Qu Systems

The Qu mixer has sockets for all its inputs and outputs on its rear panel and can therefore be used without any additional rack. However, if you wish to use a digital snake to connect remote stage audio to the mixer using a single Cat5 cable then there are several rack options available. The following diagrams show suggested combinations:

Qu-16 – All inputs and outputs are available locally. Use on stage or with an analogue snake.

Qu-16

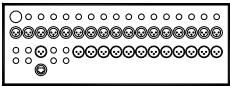

Qu-16+AR84 – 8 remote inputs. Provides 4 outputs, ideal for feeding a stereo PA and two monitors.

Qu-16

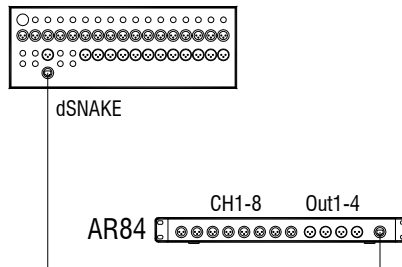

Qu-16+AR2412 – Access all inputs and outputs near the stage. ST1-3 provide stereo mic inputs.

Qu-16

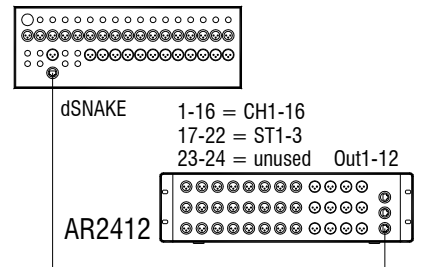

Qu-16+AB168 – Provides a rugged digital snake and stage box for all 16 mic inputs and up to 8 returns.

Qu-16

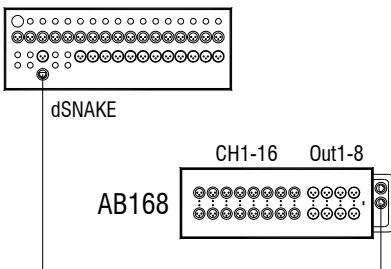

Qu-16+2x AB168 – A second stage box expands the first to access ST1-3 on its first 6 inputs and provides more outputs. Inputs 7-16 are not used.

Qu-16

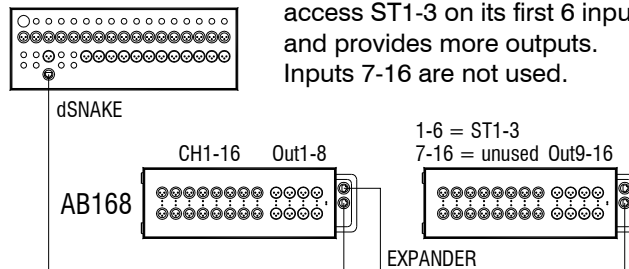

Qu-24 – All inputs and outputs are available locally.

Qu-24

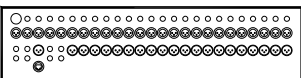

Qu-24+AR84 – 8 remote inputs. Provides 4 outputs

Qu-24

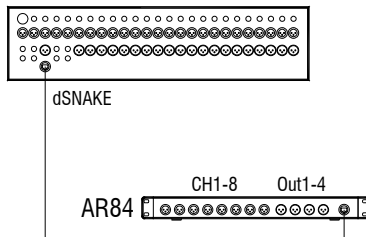

Qu-24+AR2412 – Access all 24 mic inputs near the stage.

Qu-24

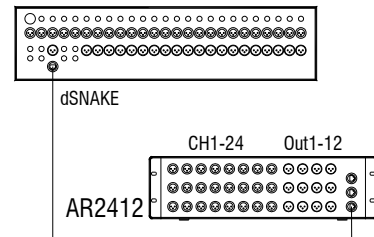

Qu-24+AR2412+AR84 – Adds the ST1-3 stereo mic inputs near the stage.

Qu-24

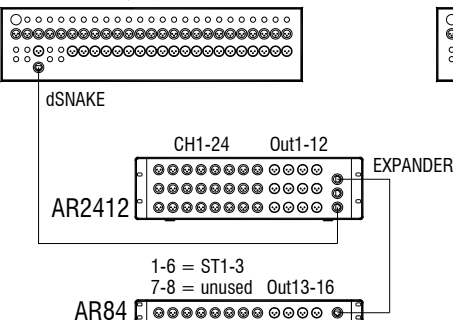

Qu-24+AB168 – Digital snake for 16 mic inputs on stage.

Qu-24

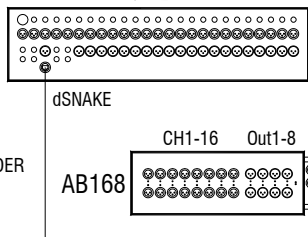

Qu-24+2x AB168 – Expands with a second stage box to access all inputs.

Qu-24

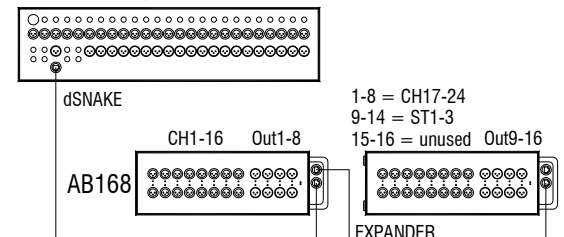

Qu-32 – All inputs and outputs are available locally.

Qu-32

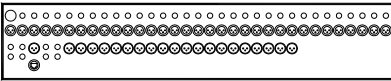

Qu-Pac – Same engine as Qu-32 but has 16 inputs and same outputs as Qu-16 available locally. Use dSNAKE to access the others.

Qu-32+AR84 – 8 remote inputs. Provides 4 outputs

Qu-32

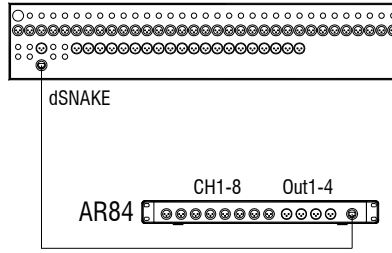

Qu-32+AR2412 – Access to 24 mic inputs near the stage.

Qu-32

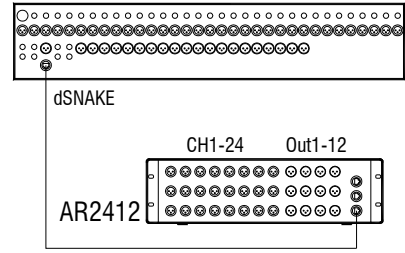

Qu-32+AB168 – Digital snake for 16 mics on stage.

Qu-32

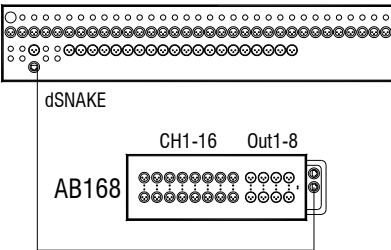

Qu-32+2x AB168 – Add a second AB168 for 32 mics on stage.

Qu-32

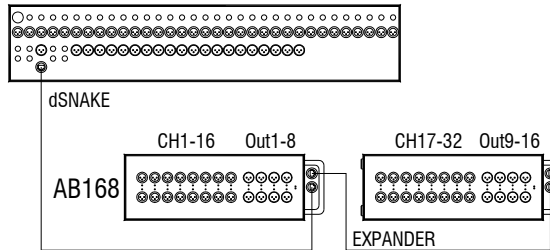

Qu-32+AR2412+AR84 – Provides all 32 mic inputs near the stage.

Qu-32

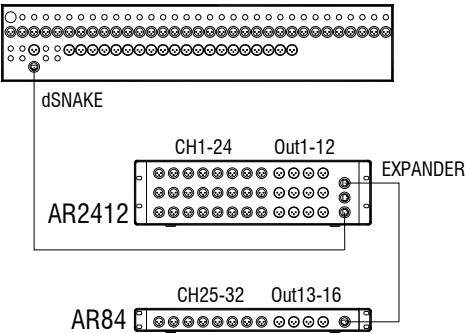

Qu-32+AR2412+AB168 – Access to all inputs including stereos.

Qu-32

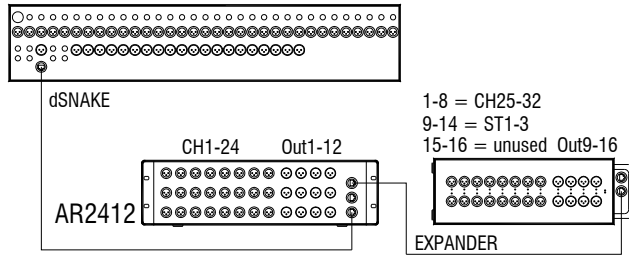

ME Personal Mixing System – The Qu system can interface directly or via the ME-U hub to ME-1 personal mixers using any available dSNAKE, EXPANDER or MONITOR port.

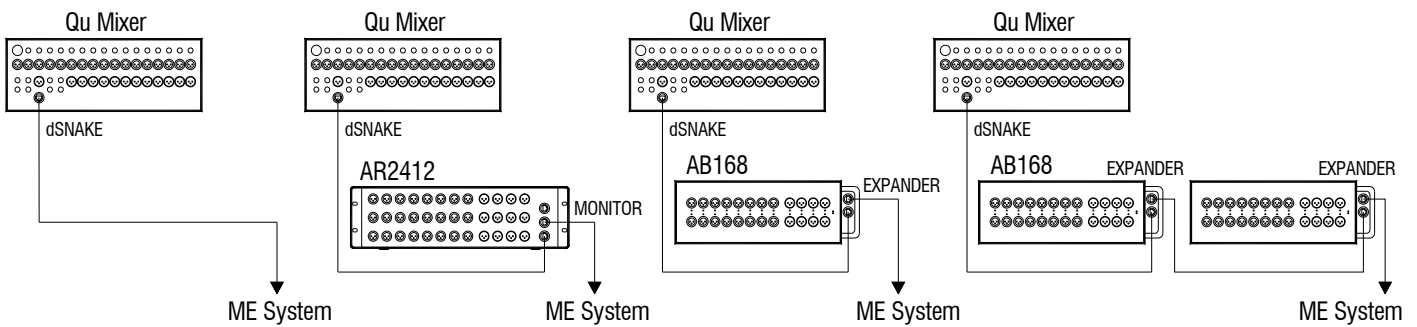

Parallel connection

Use the ME-U hub or a standard PoE hub to power and connect to several ME-1 mixers using individual Cat5 cables.

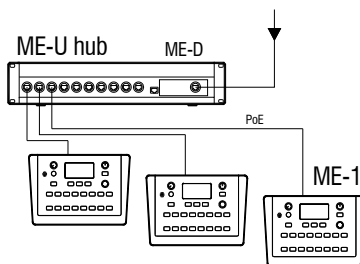

Daisy chain connection

Connect to Link In of the first ME-1 mixer. Connect its Link Out to daisy chain to the next. Use the power units provided with each ME-1 mixer.

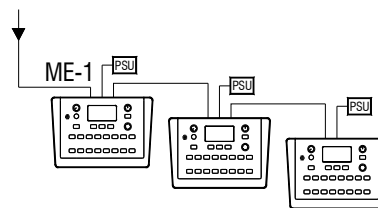

Qu-16 16 Mic/Line



24 out, 22 in USB audio streaming

Qu-24 24 Mic/Line in



32 out, 30 in USB audio streaming

4 Group out Matrix out

Qu-32 32 Mic/Line in



32 out, 32 in USB audio streaming

8 Group out

Matrix out



AudioRacks - All models are compatible with the optional Allen & Heath AB168, AR2412 and AR84 AudioRacks. These provide remote mic inputs and line outputs that connect to the mixer using a Cat5 'digital snake' cable up to 100m long. You can connect up to two AudioRacks the second as an expander to the first.

ⓘ The AR2412 AudioRack cannot be used as an expander in a Qu system.

Available AudioRacks:

AB168 16 Mic/Line in, 8 Line out - Floor, shelf or rack mount

The AB168 AudioRack can be used as a stage box on the floor or a surface, or mounted in a 19" rack using the optional rack ears.



EXPANDER – To connect to a second AB168 to add more input and output sockets. Also compatible with the Allen & Heath ME personal mixing system.

dSNAKE – To connect to the Qu mixer using a Cat5 digital snake.

AR2412 24 Mic/Line in, 12 Line out - Rack mount

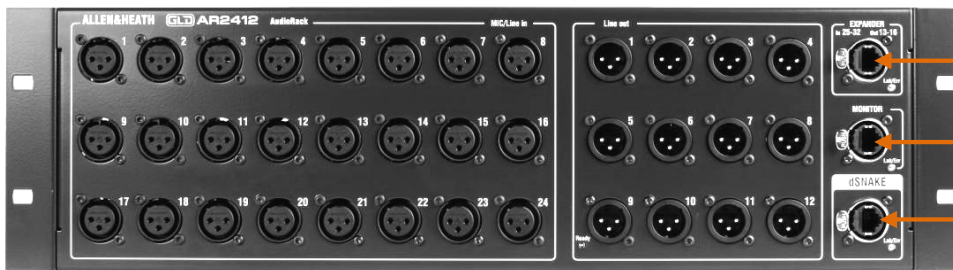

EXPANDER – To connect to an AR84 or AB168 to add more input and output sockets.

MONITOR – To connect to the Allen & Heath ME personal mixing system.

dSNAKE – To connect to the Qu mixer using a Cat5 digital snake.

AR84 8 Mic/Line in, 4 Line out - Rack mount



EXPANDER – To connect to the Expander port of the AR2412, or connect directly to the Qu mixer via its dSNAKE port.

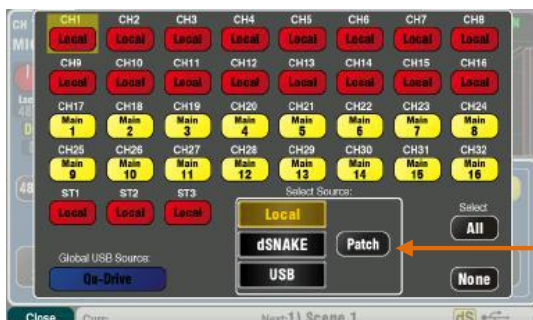

Inputs – Use the **Preamp** screen **Fn** key **Source** page to choose either the local (rear panel) socket or a remote (dSNAKE) socket for each channel source. Red buttons show local sources selected, yellow buttons show dSNAKE sources.

Any dSNAKE input socket can be patched to any channel using the **Setup / I/O Patch / dSNAKE In** screen. Sockets can be patched to more than one channel.

The **Qu-16, 24, 32** reset default is one-to-one mapping of local sockets to the channels.

The **Qu-Pac** reset default is one-to-one mapping of local sockets to CH1-16, and dSNAKE 1-16 sockets to CH17-32.

i Adding an AudioRack does not expand the number of Qu channels available.

Outputs – The Qu mixer outputs will appear simultaneously at its rear panel sockets and also at the sockets on the remote rack. AudioRack output sockets are patchable. Qu outputs can be patched to the rack sockets using the **Setup / I/O Patch / dSNAKE Out** screen.

11.14 I/O Patch Setup – Surface



Use this screen to patch signals to the rear panel Alt Out and AES outputs. Touch a box to open up the list of available options. Changes are applied instantly. You can also touch outside the list to exit.

Alt Out – Choose the source for the rear panel stereo Alt Out jacks.

AES Out – Choose the source for the rear panel AES digital output.

The reset default for both is LR post-fade.

Group and Matrix outputs are not available on the Qu-16.

The Alt Out and AES Out are not provided on Qu-SB.



11.15 I/O Patch – dSNAKE In

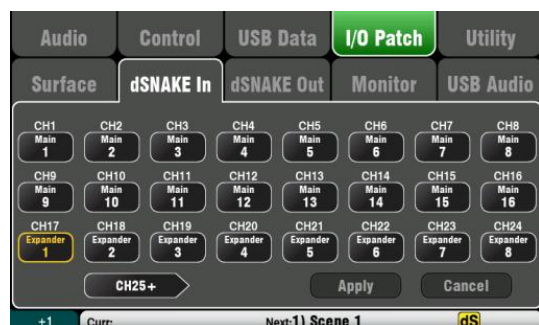

Use this screen to patch AudioRack input sockets to the Qu input channels. You can connect up to two AudioRacks via the dSNAKE Cat5 digital snake.

The button code indicates dSNAKE device:

N/C = No AudioRack is connected

Main = First AudioRack

Expander = Second AudioRack (expander)

Touch a Channel box and turn the screen rotary to scroll through the dSNAKE socket numbers. These relate to the AudioRacks currently connected, or to the dSNAKE channels if no AudioRack is found.

Any AudioRack socket can be patched to any channel. A socket can be patched to more than one channel. A channel can only have one socket patched to it.

Touch **Apply** to confirm changes.

The reset default for the Qu-16, Qu-24 and Qu-32 models is one-to-one mapping of sockets to channels.

The reset default for Qu-SB and Qu-Pac is:

CH1-16 = Local 1-16,
CH17-32 = dSNAKE 1-16

This is because Qu-Pac and Qu-SB can be used as a stage rack with their 16 local inputs as the source to CH1-16. One AudioRack connected to the dSNAKE port could feed CH17-32 to provide the full 32 channels.

Input patching is stored in Scene memories.

11.16 I/O Patch Setup – dSNAKE Out



This screen presents the patching for the dSNAKE remote audio outputs. These outputs can be mapped from any combination of Qu mixer output sources.

The Qu mixer detects which AudioRack type is connected. A Qu system can have up to two AudioRacks connected. These are shown as:

dSNAKE – The first (main) AudioRack connected.

Expander – The second (expander) AudioRack.

dSNAKE outputs can be patched with or without physical AudioRacks connected.

The following sources can be patched:

X	Unassigned
Grp	Group post-fader
Mix	Mix 1-10 post-fader
LR pre	LR mix – pre-fader
LR post	LR mix – post-fader
L+R pre	LR mono sum – pre-fader
L+R	LR mono sum – post-fader
MTX	Matrix post-fader
PAFL	Stereo PAFL monitor

All Qu mixer patching is stored in Scene memories. The Reset Mix Settings defaults are shown below:

Qu-16 Reset dSNAKE Patch

dSNAKE	Qu out	Ch	Qu out	Exp	Qu out
1	Mix 1	9	Mix 9	1	none
2	Mix 2	10	Mix 10	2	none
3	Mix 3	11	L	3	none
4	Mix 4	12	R	4	none
5	Mix 5			5	none
6	Mix 6			6	none
7	Mix 7			7	none
8	Mix 8			8	none

Qu-24, Qu-32, Qu-Pac, Qu-SB Reset dSNAKE Patch

dSNAKE	Qu out	Ch	Qu out	Exp	Qu out
1	Mix 1	9	Mix 9	1	MTX1 L
2	Mix 2	10	Mix 10	2	MTX2 R
3	Mix 3	11	L	3	MTX3 L
4	Mix 4	12	R	4	MTX4 R
5	Mix 5			5	Grp1 L
6	Mix 6			6	Grp2 R
7	Mix 7			7	Grp3 L
8	Mix 8			8	Grp4 R