

ALLEN & HEATH

 **XONE:62**
PROFESSIONAL DJ MIXER

USER GUIDE

Publication AP4145

Limited One Year Warranty

This product has been manufactured in the UK by ALLEN & HEATH and is warranted to be free from defects in materials or workmanship for period of one year from the date of purchase by the original owner.

To ensure a high level of performance and reliability for which this equipment has been designed and manufactured, read this User Guide before operating. In the event of a failure, notify and return the defective unit to ALLEN & HEATH or its authorised agent as soon as possible for repair under warranty subject to the following conditions

Conditions Of Warranty

1. The equipment has been installed and operated in accordance with the instructions in this User Guide
2. The equipment has not been subject to misuse either intended or accidental, neglect, or alteration other than as described in the User Guide or Service Manual, or approved by ALLEN & HEATH.
3. Any necessary adjustment, alteration or repair has been carried out by ALLEN & HEATH or its authorised agent.
4. This warranty does not cover crossfader wear and tear.
5. The defective unit is to be returned carriage prepaid to ALLEN & HEATH or its authorised agent with proof of purchase.
6. Units returned should be packed to avoid transit damage.

In certain territories the terms may vary. Check with your ALLEN & HEATH agent for any additional warranty which may apply.



This product complies with the European Electromagnetic Compatibility directives 89/336/EEC & 92/31/EEC and the European Low Voltage Directives 73/23/EEC & 93/68/EEC.

This product has been tested to EN55103 Parts 1 & 2 1996 for use in Environments E1, E2, E3, and E4 to demonstrate compliance with the protection requirements in the European EMC directive 89/336/EEC. During some tests the specified performance figures of the product were affected. This is considered permissible and the product has been passed as acceptable for its intended use. Allen & Heath has a strict policy of ensuring all products are tested to the latest safety and EMC standards. Customers requiring more information about EMC and safety issues can contact Allen & Heath.

NOTE: Any changes or modifications to the console not approved by Allen & Heath could void the compliance of the console and therefore the users authority to operate it.

XONE:62 User Guide AP4145 Issue 4

Copyright © 2004 Allen & Heath Limited. All rights reserved

Manufactured in the United Kingdom by

ALLEN&HEATH

Allen & Heath Limited

Kernick Industrial Estate, Penryn, Cornwall, TR10 9LU, UK

<http://www.allen-heath.com>

Important Safety Instructions

WARNINGS - Read the following before proceeding :



ATTENTION: RISQUE DE CHOC ELECTRIQUE – NE PAS OUVRIR

- Read instructions:** Retain these safety and operating instructions for future reference. Adhere to all warnings printed here and on the console. Follow the operating instructions printed in this User Guide.
- Do not remove cover:** Operate the console with its covers correctly fitted. Disconnect mains power by unplugging the power cord if the cover needs to be removed for setting internal options. Refer this work to competent technical personnel only.
- Power sources:** Connect the console to a mains power only of the type described in this User Guide and marked on the rear panel. Use the power cord with sealed mains plug appropriate for your local mains supply as provided with the console. If the provided plug does not fit into your outlet consult your service agent for assistance.
- Power cord routing:** Route the power cord so that it is not likely to be walked on, stretched or pinched by items placed upon or against it.
- Grounding:** Do not defeat the grounding and polarisation means of the power cord plug. Do not remove or tamper with the ground connection in the power cord.



WARNING: This equipment must be earthed.

- Water and moisture:** To reduce the risk of fire or electric shock do not expose the console to rain or moisture or use it in damp or wet conditions. Do not place containers of liquids on it which might spill into any openings.
- Ventilation:** Do not obstruct the ventilation slots or position the console where the air flow required for ventilation is impeded. If the console is to be operated in a rack unit or flightcase ensure that it is constructed to allow adequate ventilation.
- Heat and vibration:** Do not locate the console in a place subject to excessive heat or direct sunlight as this could be a fire hazard. Locate the console away from any equipment which produces heat or causes excessive vibration.
- Servicing:** Switch off the equipment and unplug the power cord immediately if it is exposed to moisture, spilled liquid, objects fallen into the openings, the power cord or plug become damaged, during lightening storms, or if smoke, odour or noise is noticed. Refer servicing to qualified technical personnel only.
- Installation:** Install the console in accordance with the instructions printed in this User Guide. Do not connect the output of power amplifiers directly to the console. Use audio connectors and plugs only for their intended purpose.



Important Mains plug wiring instructions.

The console is supplied with a moulded mains plug fitted to the AC mains power lead. Follow the instructions below if the mains plug has to be replaced.

The wires in the mains lead are coloured in accordance with the following code:

TERMINAL		WIRE COLOUR	
		European	USA/Canada
L	LIVE	BROWN	BLACK
N	NEUTRAL	BLUE	WHITE
E	EARTH GND	GREEN & YELLOW	GREEN

The wire which is coloured Green and Yellow must be connected to the terminal in the plug which is marked with the letter E or with the Earth symbol.
This appliance must be earthed.

The wire which is coloured Blue must be connected to the terminal in the plug which is marked with the letter N.

The wire which is coloured Brown must be connected to the terminal in the plug which is marked with the letter L.

Ensure that these colour codes are followed carefully in the event of the plug being changed.

Precautions

Damage :

To prevent damage to the controls and cosmetics avoid placing heavy objects on the control surface, scratching the surface with sharp objects, or rough handling and vibration.

Environment :

Protect from excessive dirt, dust, heat and vibration when operating and storing. Avoid tobacco ash, smoke, drinks spillage, and exposure to rain and moisture. If the console becomes wet, switch off and remove mains power immediately. Allow to dry out thoroughly before using again.

Cleaning :

Avoid the use of chemicals, abrasives or solvents. The control panel is best cleaned with a soft brush and dry lint-free cloth. The faders, switches and potentiometers are lubricated for life. The use of electrical lubricants on these parts is not recommended.

Transporting :

The console may be transported as a free-standing unit or mounted in a rack or flightcase. Protect the controls from damage during transit. Use adequate packing if you need to ship the unit.

Hearing :



To avoid damage to your hearing do not operate any sound system at excessively high volume. This also applies to any close-to-ear monitoring such as headphones. Continued exposure to high volume sound can cause frequency selective or wide range hearing loss. Make sure that your system complies with any venue sound level and noise regulations which may apply.

Introduction

This user guide presents a quick reference to the **XONE:62**. We recommend that you read this fully before starting. Included is information on installing, connecting and operating the console, panel drawings, system block diagram and technical specification. For further information on the basic principles of audio system engineering, please refer to one of the specialist publications available from bookshops and audio equipment dealers.

Whilst we believe the information in this guide to be reliable we do not assume responsibility for inaccuracies. We also reserve the right to make changes in the interest of further product development.

Note that this user guide refers to the revised model **XONE:62**. This has minor changes from the original model which it replaces. The order code for the revised model is XONE2:62/. The changes include new styling with textured silver painted panel replacing the original stainless steel finish, new knob style, a rotary rather than slider master level control, and new high grade Penny & Giles crossfader instead of the original Alps version. The new crossfader is not interchangeable with the older type.

We are able to offer further product support through our world-wide network of approved dealers and service agents. You can also access our Web site on the Internet for information on our product range, assistance with your technical queries or simply to chat about matters audio. To help us provide the most efficient service please keep a record of your console serial number, and date and place of purchase to be quoted in any communication regarding this product.

Check out our home site for information on the company and its pedigree, our full product range and our design philosophy. We also have a site dedicated to the exciting **XONE** console range.

www.allen-heath.com

www.xone.co.uk

Contents

Warranty	2	Earthing.....	16
Important Safety Instructions.....	3	Plugging up the System	17
Precautions	4	Cables and Connectors.....	18
Front and Rear Panel Drawings.....	6	Input Channels	20
Welcome to the XONE:62	7	Crossfader and VCF	22
The Application	8	Replacing the Crossfader.....	23
Specifications	10	Filters Type Select	24
Block Diagram.....	11	Master Mix and Monitor System.....	25
Input and Output Connections	11	Glossary	27
Quick Start.....	12	Tips and Troubleshooting	30
Gain and Operating Levels	15	Cue Sheet	31
Connecting Mains Power.....	16	Internet Site.....	Rear Cover

XONE:62
PROFESSIONAL DJ MIXER

CAUTION
AVIS: RISQUE DE CHOC ELECTRIQUE - NE PAS OUVRIE.
REFER TO USER GUIDE BEFORE CONNECTING SUPPLY.
NO USER RESPONSIBLE PARTS IN CASE.
NE PAS OUVRIE TO OBTAIN SERVICE PERSONNEL.
TO REDUCE THE RISK OF FIRE OR ELECTRIC SHOCK
DO NOT EXPOSE THIS APPARATUS TO RAIN OR MOISTURE.

USER
WARNING - THIS APPARATUS MUST BE EARTHED.
AC MAINS IN -

ALLEN&HEATH

MONO OUT
BOOTH L R
AUX OUT L R
CLEAN FEED

RECORD OUT L R
CLEAN FEED -10dBV

PHONO - LINE L R
INPUT 6
PHONO - LINE L R
INPUT 5
PHONO - LINE L R
INPUT 4
PHONO - LINE L R
INPUT 3

MIX OUT RIGHT LEFT
PRE=

INPUT 2 L/M R
MIC LINE
INPUT 1 L/M R
MIC LINE

SERIAL No: [REDACTED]
SUPPLY VOLTAGE RANGE:
100 - 240V
47-63Hz - 30W MAX
100 - 240V - 1500mA 250V 20mm

WARNING: FOR CONTINUED PROTECTION AGAINST FIRE OR FIRE
REPLACE FUSE WITH SAME TYPE AND RATING
ATTENTION: REMPLACER LE FUSEAU AVEC UN DES MEMES CARACTERISTIQUES.

Made in the UK by ALLEN & HEATH

ALLEN&HEATH

XONE:62
PROFESSIONAL DJ MIXER

MONITOR
L R
+6
+5
+3
+1
0
-1
-3
-5
-7
-10
-15
-20
CUE PRG L-SPLIT

AUX PRE
PHONO Line
GAIN
HI
MID 1
MID 2
LO
EQ ON

1 MIC 2 3 4 MUSIC 5 6
CUE
PK
XFAD
ON
X Y L
L

MASTER
MAIN MIX
RESONANCE
MILD WILD
HPF
BPF
LPF
VCF RESPONSE
PHONES
Crossfader By **Perry+Glas**

VCF 100Hz 20kHz
FILTER ON
CURVE
VCA
VCF 100Hz 20kHz
FILTER ON

XFAD PAN
SPLIT CUE
AUX
MONO
BOOTH MONITOR
Checked
MUTE

Welcome to the XONE:62

The Allen & Heath **XONE:62** presents a unique combination of performance tools for the professional DJ in a stylish and solidly built club format. Above all, it features sound quality second to none. **XONE:62** has been designed and constructed using the same rigorous standards we apply to our large format professional consoles used and respected by top engineers throughout the world. We have had great fun designing this new range. We are sure you will get even more enjoyment using it.

XONE:62 provides **6 dual stereo channels**, with A and B inputs on each, two offering mic inputs, adding up to a massive 10 stereo and 2 microphone inputs. A full range of connectors means that you can connect up to 4 turntables, 2 mics, CD players, MD players, drum machines, samplers, and pretty much anything else you might want to bring into the mix.

The more bands of EQ you have, the more creative you can get with your mix. That is why we give you **4 EQ controls** rather than the usual 3. Each band has a safe +6dB boost and a massive –26dB of cut, enough to creatively shape your sound well beyond normal EQ range, and without overloading your system. Punch the effect in or out using the EQ on switch.

Channels 3 to 6 can be assigned to either side of the high spec Penny & Giles **VCA crossfader**. This controls the audio using a DC voltage meaning that it can take a huge amount of punishment without the bangs and crackles that inevitably creep in on regular audio faders. It is easily removable from the top panel for quick replacement should it become worn. The curve can be switched to either dipped response, ideal for seamless beat mixing, or to dipless better suited to scratch or cut mixing.

Unique to **XONE**, two stereo state variable **Voltage Controlled Filters** provide the DJ with a new level of live performance creativity. These are very similar to those found on classic analogue synths but benefit from modern, quiet and stable technology. Use these to sweep the sound by accentuating or cutting frequencies from 100Hz to 20kHz. The 3 filter types HPF, BPF and LPF can be combined to create many more amazing effects. A large Resonance control changes the 'Q' or sharpness of the filter effect from subtle to extreme. Each VCF has its own in/out switch.

Combined with the extensive output and monitoring features, colour coded indicators, stylish layout and clear graphics visible in all lighting situations, you have an unbeatable performance console equally at home in dance clubs, home set-ups, live venues, and on the road.

- 6 Dual stereo inputs, 2 with mic inputs
- RIAA preamps for up to 4 turntables
- A/B input selectors with 2 colour indicators
- Smooth action gain controls
- Stereo aux send with pre/post switching
- 4 Band asymmetric EQ with extended cut
- EQ in/out switches to defeat the effect
- Large illuminated cue switches
- 4 led 3 colour channel meters
- Crossfader on and assign switches
- Colour coded crossfader routing indicators
- Smooth travel 60mm faders with dust covers
- Removable Penny & Giles VCA crossfader
- Crossfader output balance control
- Crossfader output to Aux send
- Rotary master level control
- Dual stereo analogue VCF effects
- 3 Filter modes combine for more effects
- Independent frequency sweep controls
- Resonance control for subtle or wild effects
- Filter switches to punch the effect in or out
- Large blue leds indicate filter status
- Powerful headphones monitor with auto cue
- Headphones split cue and mix/aux monitoring
- Stereo music only booth monitor output
- Booth mono and mute switching
- 12 led 3 colour main meters with peak hold
- Balanced +4dBu XLR stereo mix output
- Mono sum output for zone feed or light effects
- Pre-fade recording output
- Soft touch controls gentle on the fingers
- Easy to read graphics in any lighting

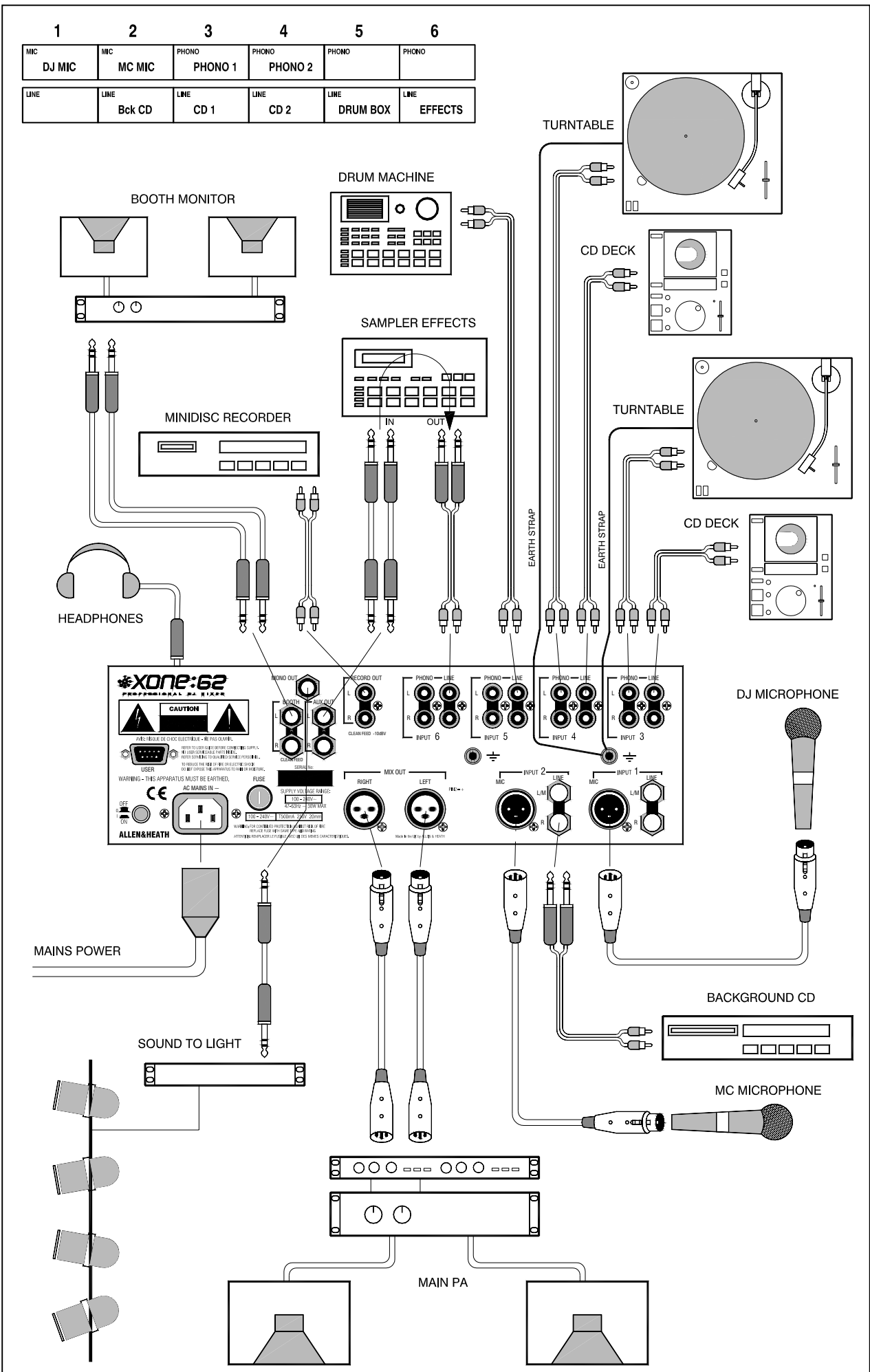

The XONE:62 Application

This diagram shows an example hook-up to demonstrate how the **XONE:62** can be connected in a typical DJ application. Note that you do not need to connect the channels in the order shown, also that the connector types on the equipment you connect to may be different to that shown. Use cables appropriate to your application. Please read **Plugging Up The System** before connecting to your equipment. The following describes how the console is used in this example application:

Microphone sources: The DJ microphone is plugged into CH1. A second mic is plugged into CH2, typically for MC or guest announcements. These signals route to the mix output and headphones. They are not routed through the crossfader, nor to the booth monitor, so avoiding potential acoustic feedback.

Background music source: A CD player plugs into CH2 line input as an alternative to the second microphone. This provides operator free background music when the DJ is not performing, typically during early evening walk in or intermission. The music routes to the mix output and is not affected by the crossfader.

Mix music sources: CH3 and CH4 are used for the mix music sources. Both a turntable and a CD deck are plugged into each, one for each side of the crossfader. The turntable magnetic cartridges plug into the RIAA equipped phono inputs, the CD into the line inputs. The required source is selected using the channel source select switch. This gives the DJ the choice of vinyl or CD mixing, or cross mixing between the two. CH3 and 4 are conveniently centred on the crossfader, ideal for easy XY crossfading.

Drum machine: It is increasingly popular for the DJ to cut in additional sources over the mix. A drum machine provides a creative instrument, ideal for enhancing the beat and bass line. This is shown plugged into CH5 stereo line input. It can be assigned to either side of the crossfader or direct to the mix as required.

Sampler effects: The stereo Aux send is used to feed selected channels to an external effects unit such as a sampler or echo device. This is typically set pre-fader so that the effect can be set up while the channel fader is down. The sampler output is returned into CH6 line input and becomes another creative source that can be added to the mix, either direct or through the crossfader.

Mix outputs: These outputs feed the house PA system to provide quality sound to the dance floor. The connections are balanced pro level +4dBu to feed long cable runs to the amplifier system. They may plug into system processors such as protection limiters, EQ and crossovers which in turn connect to the amplifiers.

Mono output: This output provides a mono sum of the left and right mix that follows the master fader. This is shown connected to a sound-to-light controller that provides lighting effects in time with the music. Alternatively, the mono output could be connected to a sub bass amplifier system to supplement left and right satellite speakers, or to a mono zone speaker system.

Recording the show: A dedicated music only stereo output connects to a recorder such as the MD shown to record the performance. Typically the mic signals are not recorded. The signal is not affected by the master mix control.

Booth monitor: A stereo speaker system provides the DJ with a music only local monitor. This can be checked or worked in mono if required, or muted if the DJ wishes to check the main PA sound or work with headphones only.

Headphones: Closed ear stereo headphones are recommended allowing the DJ to check and cue the music sources. Split-cue keeps the program in one ear while cueing with the other to synchronise the beat before introducing the source into the mix.

Specifications

0dBu = 0.775 Volts rms, +4dBu = 1.23V rms 0dBV = 1 Volt rms, -10dBV = 316mV rms

Max output level	XLR +26dBu into >2k ohm TRS +21dBu into >2k ohm RCA +15dBu into >10k ohm	Ch meters	Peak reading 4 led -16, 0, +6, +12 (PK)
Headroom	Channels +21dB Mix to output +23dB	Main meters	Peak reading 12 led -20 to +8
Freq response	+0/-1dB 20Hz to 40kHz	Mic EQ	4-Band +/-15dB 100, 250, 2.5k, 10kHz
Distortion	< 0.006% THD+noise @1kHz	Music EQ	4-Band +6 / -26dB 100, 250, 2.5k, 10kHz
Crosstalk	< 90dB Channel shutoff @1kHz	Ch fader	60mm stereo
MIC EIN 22-22kHz	-128dB 150 ohm source	Mix fader	100mm stereo
Residual noise	XLR -90dBu (-94dB S/N) TRS -84dBu (-84dB S/N) RCA -92dBu (-84dB S/N)	Crossfader	45mm stereo VCA Replaceable
Mix noise	XLR -86dBu (-90dB S/N) TRS -83dBu (-83dB S/N) RCA -91dBu (-83dB S/N)	Filters	Dual stereo VCF Analogue
		Panel	Stainless steel

Power Supply

Internal switch mode power unit with auto sensing mains input.

MAINS IN socket	IEC 3 pin
Power lead	Country dependent with moulded mains plug supplied
AC mains	100 to 240V AC @ 50/60Hz
Consumption	30W max
Mains fuse rating	100-240V AC T500mA 20mm

Dimensions and Weights

The console is fitted with rubber feet for desktop operation. An optional screw on rack ear kit is available for rack or plinth mounting.

	Width	Height	Depth	Weight
Desktop	320 mm (12.6")	105 mm (4.1")	358 mm (14.1")	5 kg (11 lbs)
Rack ears fitted	370 mm (14.6")	105 mm (4.1")	358 mm (14.1")	
Packed	475 mm (18.7")	210 mm (8.3")	395 mm (15.6")	5.5 kg (12 lbs)

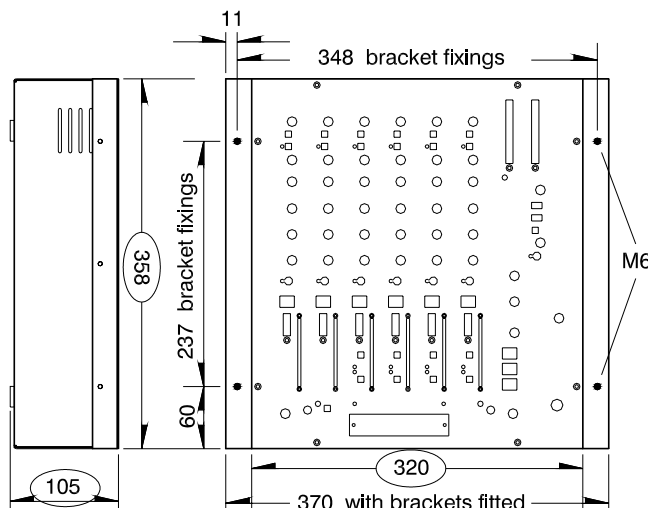

Optional Rack Ears

Allows permanent fixing in a plinth or rack system. Ears bolt on to the sides of console. Fix in place using M6 screws or bolts. Contact your Allen & Heath agent for further information.

Order code: **XONE2:62-RK**
or **XONE2:62-RK19**

XONE2:62 BLOCK DIAGRAM

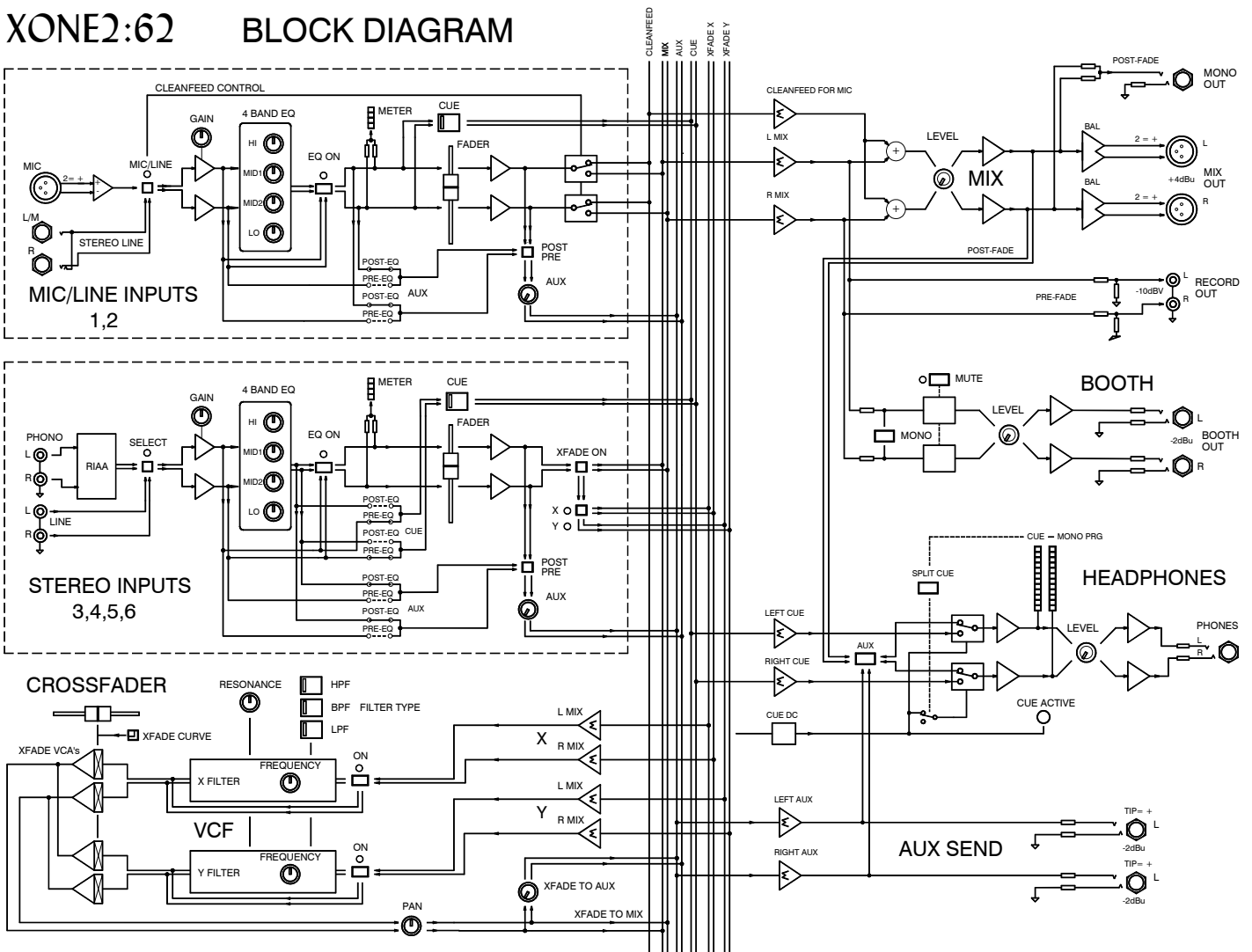

Connector Types

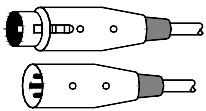

XLR male and female connectors : Pin 2 = hot (+) Pin 3 = cold (-) Pin 1 = GND
 TRS input and output connectors : Tip = hot (+) Ring = cold (-) Sleeve = GND
 RCA PHONO pin connectors

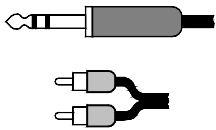

Input Connections

	Type	Impedance	Sensitivity
CH1,2 IN (Mic)	Balanced XLR female	2k ohm	-45 to -15dBu
(Stereo Line)	Unbalanced TRS jack	>10k ohm	-15 to +15dBu
CH3,4,5,6 (Phono)	RCA phono RIAA	47kohm/330pF	2 to 100mV
(Stereo Line)	RCA phono	>10k ohm	-10 to +10dBu

Output Connections

	Type	Impedance	Level
MIX OUT L,R (XLR)	Balanced XLR male	<75 ohm	+4dBu
RECORD OUT	RCA phono	<600 ohm	-10dBV
MONO OUT	Impedance balanced TRS jack	<600 ohm	-2dBu
AUX OUT L,R	Impedance balanced TRS jack	<75 ohm	-2dBu
BOOTH OUT	Impedance balanced TRS jack	<75 ohm	-2dBu
HEADPHONES	Tip = L Ring = R 30 to 600 ohm recommended		

Quick Start ►►

We recommend that you read through all sections of this User Guide before starting. However, we provide these notes so that you can plug up and experiment with sounds from your **XONE:62** immediately if you prefer to read the full guide later. Please note that you should first read and understand the **Important Safety Instructions** printed at the beginning of this guide. The following simple procedure requires a CD player and headphones. Alternatively you can connect a pair of turntables and start mixing right away. Please read the rest of this guide before connecting to your amplifier and speaker systems.

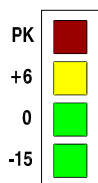
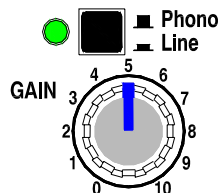
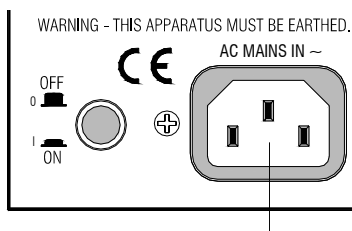
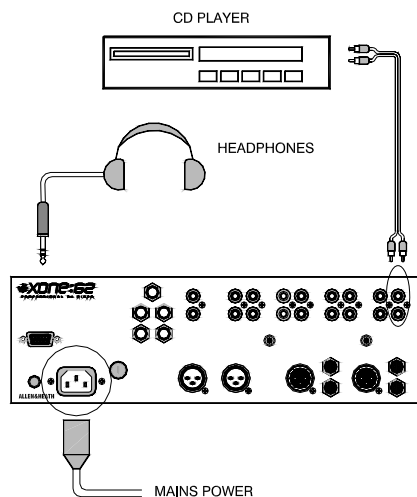

1 Set all controls to their starting condition. Set all FADERS, GAIN, AUX, VCF, RESONANCE, HEADPHONES and BOOTH MONITOR controls minimum. Set PAN and EQ controls to their detented centre position. Set all switches to their up position.

2 Plug in a CD player. This provides a good stereo audio source as a starting point. Plug into CH3 line input as shown. Do not use the phono input for CD or other line level sources as this is intended for turntables with magnetic cartridges requiring RIAA equalisation.

3 Plug in the headphones. Plug into the top panel PHONES socket. Use the best headphones you can afford for your application. We recommend the professional grade closed-ear type of 30 to 100ohms impedance, and with 1/4" TRS jack plug. Avoid using the popular mini jack to 1/4" adapters as these can quickly prove unreliable.

4 Connect AC mains power. Check first that the correct mains lead with sealed plug suitable for your local supply has been provided with your console. Plug into the AC MAINS IN socket making sure the connector is pressed fully in.

5 Switch the console on. Press the rear panel ON/OFF switch. Check that the green and red XY leds above the crossfader both light. You may notice that the console meters flash briefly. This is normal during power up.

6 Select the line source. Press the CH3 source select switch. This lights red to indicate that the line source is selected.

7 Adjust the channel gain. Start the CD player. Adjust CH3 GAIN control until the average music level lights the channel meter green 0 led with loudest peaks lighting the yellow +6 led. If no signal is present check that the music source is playing and the correct input is selected.

Reduce GAIN if the red PK Led lights. This indicator is a warning that the signal is approaching clipping and that distortion may result if the level increases further.

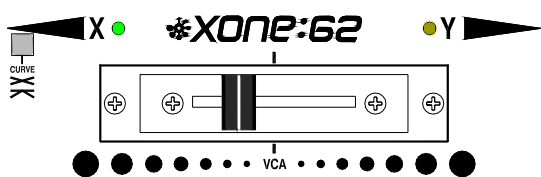
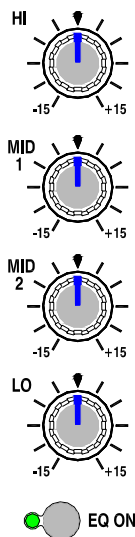
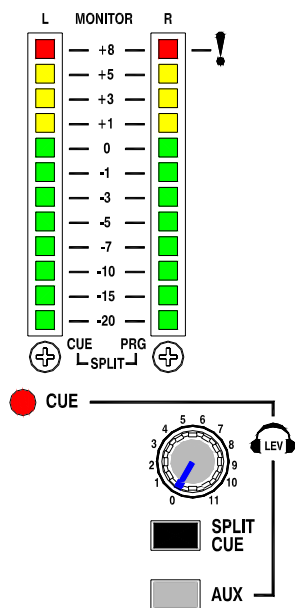

8 Check the sound using the Cue system. With the music playing press the large CUE switch. The switch lights as well as the master CUE led to show that the cue monitor is active. The channel signal is now sent to the headphones. Slowly turn up the headphones level control until you hear the music.

⚠ Avoid listening to loud headphones levels for long periods as this may damage your hearing.

The channel signal is now displayed on the main monitor meters giving you finer control in setting the gain. Note that the cue system lets you monitor the channel signals pre-fader. In other words you can check or cue any source before you raise its fader to bring it into the mix.

9 Route the signal to the main Mix output. Release the CUE switch. The CUE led turns off and the headphones and monitor meters go quiet. Raise CH3 fader to its top '0' position. Raise the MIX master rotary control to maximum. With the XFADE ON switch in its up position the signal is routed direct to the mix. The signal is now displayed on the main meters at the same level as the channel meter. The level is now the same throughout the console signal path, as set by the channel gain control. This is the ideal setting with meters averaging 0dB so giving the best signal-to-noise performance while maintaining plenty of headroom to avoid clipping.

10 Listen to the main MIX output. The music should be heard in the headphones. If not, then check that the AUX switch is released and that no CUE switches are selected.

11 Check the effect of the Stereo EQ. Press CH3 EQ ON switch. This lights to show that the signal is routed through the equaliser. Now try the effect of each of the 4 frequency bands. The EQ is designed for creative live performance control and provides a safe +6dB boost and a massive -26dB cut. Experiment with cutting rather than boosting frequencies to create dramatic effects. These can be punched in or out using the EQ ON switch.

12 Route through the Crossfader. Press XFADE ON to route the signal through the crossfader rather than direct to the mix. The green X led lights indicating that the channel is assigned to the left (X) side of the crossfader. Press the XY switch to assign the signal to the right (Y) side. The yellow Y led lights. Note the green X and yellow Y led above the crossfader to help you see where the channels are routed.

13 Using the Crossfader. This lets you fade between signals routed to either side, typically to fade smoothly into a new music track or to creatively layer sounds when scratch or cut mixing. Experiment further by connecting two CD decks or turntables and assigning one to X, the other to Y. Use XFADE PAN to adjust the balance between the left and right mix, either to correct an imbalance or as an effect in its own right.

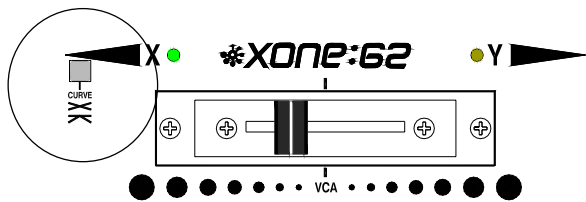

14 Changing the crossfader curve. The little switch to the left of the crossfader sets which curve is active. In the normal up position the signal dips by 6dB at the middle position for smooth fading between tracks. Press the switch for a dipless response where the signal starts to dip only once the fader has passed the mid position. This is better suited to scratch or cut mixing where you layer the sounds.

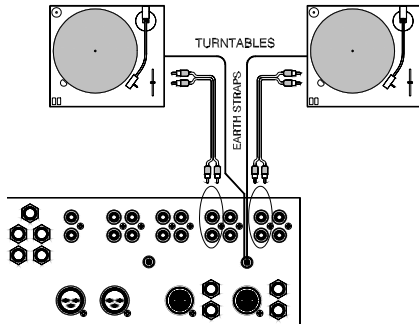

15 Crossfader mixing. At this point you may wish to plug in a pair of turntables and experiment with DJ mixing. Plug into CH3 and CH4 phono inputs if your turntables require RIAA equalisation. If not, plug into the line inputs. Remember to connect the turntable earth leads to the console chassis earth terminal. Use CUE to set up the channel gain as you did in step 7. Route CH3 to X and CH4 to Y of the crossfader.

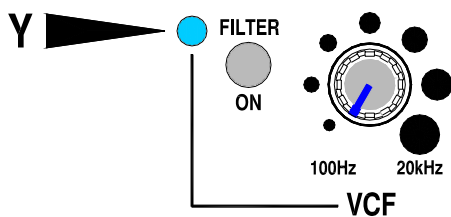

16 Adding VCF filter effects. Each side of the crossfader features a stereo Voltage Controlled Filter which presents the DJ with a unique set of live performance tools to create subtle or startling tonal effects. With the signal assigned to the Y side of the crossfader, and the crossfader moved fully to the right, the music is routed to the mix and should be heard on the headphones. Press the Y FILTER switch to route the signal through the analogue filter section. The blue led lights to show that the filter is active. Check that the large LPF switch is illuminated indicating that the power up default lo-pass filter type is active. The sound should change to a rumbling bass line with higher frequencies removed.

17 Sweep the filter frequency. Turn the VCF control clockwise and you should progressively hear higher audio frequencies returning to the mix. This control sweeps the effect from low to high frequency.

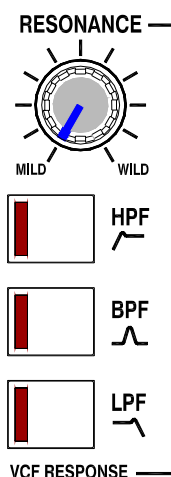

18 Adjust the filter resonance. Slowly turn the RESONANCE control clockwise as you sweep the frequency and you should hear the 'Q' or 'sharpness' of the effect changing from subtle to drastic as the roll-off knee sharpens and frequency boost is added.

⚠ Increasing resonance boosts a narrow band of selected frequencies. Make sure you reduce the channel gain if the red peak meters start to flash.

19 Change the filter type. Press one or any combination of the large HPF, BPF and LPF filter type switches to experiment with different performance effects. For example pressing HPF and LPF together produces a notch effect. Once you are familiar with the creative power of these filters you can apply them to your performance. More information is available later.

Now... continue to read through the rest of this User Guide.



Gain and Operating Levels



It is most important that the system gain and level settings are correctly set. It is well known that many DJs push the gain to maximum with meters peaking hard in the belief that they are getting the best from the system. **THIS IS NOT THE CASE!** The best can only be achieved if the system levels are set within the normal operating range and not allowed to peak. Peaking simply results in signal distortion, not more volume. It is the specification of the amplifier / speaker system that sets the maximum volume that can be achieved, not the console. The human ear too can fool the operator into believing that more volume is needed. Be careful as this is in fact a warning that hearing damage will result if high listening levels are maintained. Remember that it is the **QUALITY** of the sound that pleases the ear, not the **VOLUME**.

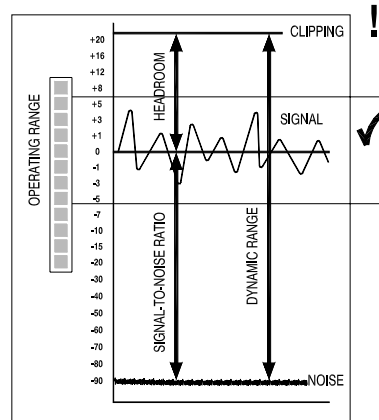
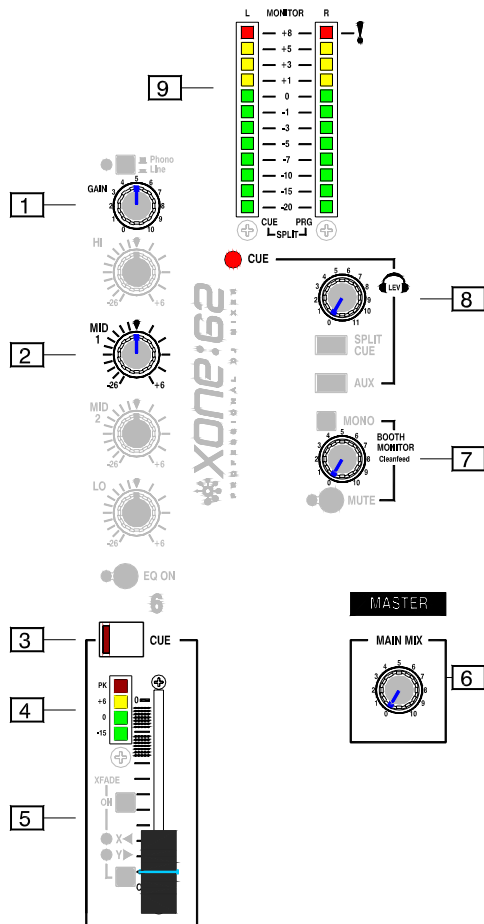

The diagram above illustrates the operating range of the audio signal.

NORMAL OPERATING RANGE. For normal music the signal should range between -5 and $+5$ on the meters with average around 0dB . This allows enough **HEADROOM** for unexpected peaks before the signal hits its maximum **CLIPPING** voltage and distorts. It also achieves the best **SIGNAL-TO-NOISE-RATIO** by keeping the signal well above the residual **NOISE FLOOR** (system hiss). The **DYNAMIC RANGE** is the maximum signal swing available between the residual noise floor and clipping. The **XONE:62** provides a massive 110dB dynamic range.

Use the **GAIN TRIM** [1] to match the input source to the normal operating level of the console. Adjust this so that the **CHANNEL METER** [4] averages 0dB with loudest moments reading $+6$. Press the **CUE SWITCH** [3] to listen to the signal on headphones and check the level on the expanded range **MAIN METERS** [9]. Adjust the **CHANNEL FADER** [5] and **MASTER FADER** [6] so that they normally operate in the shaded area near the top. Make sure the amplifier/speaker system has been correctly calibrated for the loudest volume required at the fader top position. Boosting the **EQ** [2] also adds gain to the system. Reduce by turning back the **GAIN TRIM** [1] if the meter red peak leds flash. Adjust the **HEADPHONES** [8] and **BOOTH** [7] monitor controls for safe listening levels.

A final note ... The human ear is a remarkable organ with the ability to compress or 'shut down' when sound levels become too high. Do not interpret this natural response as a reason to turn the system volume up further! As the session wears on ear fatigue may set in, and the speaker cones may become hot so reducing the effectiveness of the system and listeners to gain any benefit from increased volume.

BE SENSIBLE, BE SAFE WITH SOUND LEVELS



Connecting Mains Power

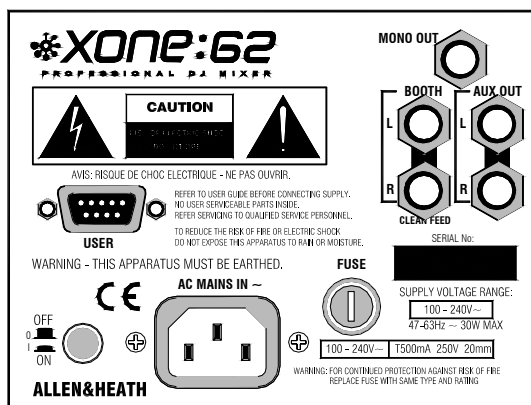

Read the **SAFETY INSTRUCTIONS** printed at the front of this User Guide and on the rear panel. Check that the correct mains lead with moulded plug has been supplied with your console. The power supply accepts mains voltages within the range 100-240V without changing any fuses or settings.

It is standard practice to turn connected power amplifiers down or off before switching the console on or off. This prevents any audible switch-on thumps. Ensure that the IEC mains plug is pressed fully into the rear panel socket before switching on.

Earthing



The connection to earth (ground) in an audio system is important for two reasons:

1. **SAFETY** - To protect the operator from high voltage electric shock, and
2. **AUDIO PERFORMANCE** - To minimise the effect of earth (ground) loops which result in audible hum and buzz, and to shield the audio signals from interference.

For safety it is important that all equipment earths are connected to mains earth so that exposed metal parts are prevented from carrying high voltage which can injure or even kill the operator. It is recommended that the system engineer check the continuity of the safety earth from all points in the system including microphone bodies, turntable chassis, equipment cases, and so on.

The same earth is also used to shield audio cables from external interference such as the hum fields associated with power transformers, lighting dimmer buzz, and computer radiation. Problems arise when the signal sees more than one path to mains earth. An 'earth loop' (ground loop) results causing current to flow between the different earth paths. This condition is usually detected as a mains frequency audible hum or buzz.

To ensure safe and trouble-free operation we recommend the following:

- **Have your mains system checked by a qualified electrician.** If the supply earthing is solid to start with you are less likely to experience problems.
- **Do not remove the earth connection from the console mains plug.** The console chassis is connected to mains earth through the power cable to ensure your safety. Audio 0V is connected to the console chassis internally. If problems are encountered with earth loops operate the audio 'ground lift' switches on connected equipment accordingly, or disconnect the cable screens at one end, usually at the destination.
- **Make sure that turntables are correctly earthed.** A chassis earth terminal is provided on the console rear panel to connect to turntable earth straps.
- **Use low impedance sources** such as microphones and line level equipment rated at 200 ohms or less to reduce susceptibility to interference. The console outputs are designed to operate at very low impedance to minimise interference problems.
- **Use balanced connections for microphones and mix output** as these provide further immunity by cancelling out interference that may be picked up on long cable runs. To connect an unbalanced source to a balanced console input, link the cold input (XLR pin 3 or jack ring) to 0V earth (XLR pin 1 or jack sleeve) at the console. To connect a balanced XLR output to unbalanced equipment, link the cold output to 0V earth at the console.
- **Use good quality cables and connectors** and check for correct wiring and reliable solder joints. Allow sufficient cable loop to prevent damage through stretching.
- **If you are not sure ...** Contact your service agent or local Allen & Heath dealer for advice.

Plugging Up The System

The **XONE:62** uses professional grade 3 pin XLR, 1/4" TRS jack and RCA PHONO sockets. To ensure best performance, we recommend that you use high quality audio cables and connectors, and take time to check for reliable and accurate cable assembly. It is well known that many audio system failures are due to faulty interconnecting leads. The following mating plugs may be used to connect audio signals to the console:

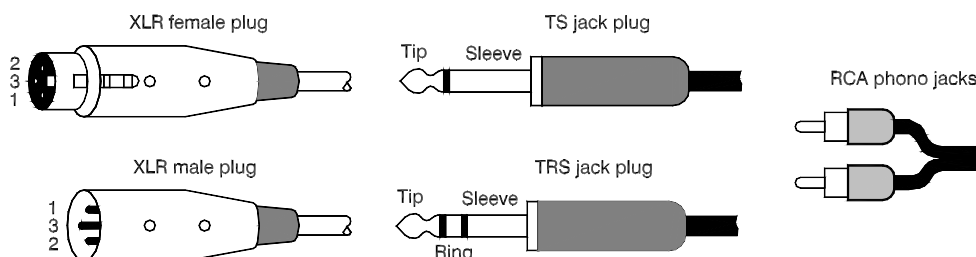

The input and output **XLR** connectors are 3 wire differentially balanced. These have 3 connector pins: Pin 1 = ground (screen), Pin 2 = signal hot (+), Pin 3 = signal cold (-).

The jack sockets are the 3 pole **TRS** type. These are wired to work with both the balanced TRS or the unbalanced 2 pole TS type plugs without cable modification. The sockets have 3 connector pins: Inputs and outputs are Tip = signal hot (+), Ring = signal cold (-), Sleeve = ground (screen). Headphones are Tip = left, Ring = right, Sleeve = ground.

The **RCA** phono connectors are the 2 wire unbalanced type typical of those found on equipment such as CD players, turntables and domestic amplifiers.

Avoid reversing + and - on balanced connections as this will result in out of phase signals (reverse polarity) which may cause signal cancellation effects.

Where long cables runs are required, balanced interconnections should be used. However, interconnections between more affordable 2-wire (signal, ground) unbalanced equipment and the console are unlikely to cause problems if the cables are kept short. Refer to the following diagram for unbalanced to balanced connections.

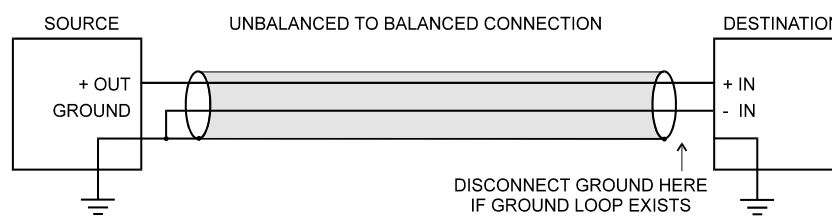

Dealing with Ground Loops, Buzz and Interference

For optimum performance all audio signals should be referenced to a solid, noise-free ground (earth) point, frequently referred to as the 'star point' or 'clean earth'.

A ground loop is created when the signal has more than one path to ground. Should you experience hum or buzz caused by ground loops, check first that each piece of equipment has its own separate path to ground. If so, operate ground lift switches on connected equipment in accordance with the instruction manuals. Alternatively disconnect the cable screen at the destination end only. This breaks the offending loop while still maintaining the signal shielding down the length of the cable.

▲ WARNING For your safety do not remove the earth (ground) connection in the power lead of the console or connected equipment.

To avoid interference pickup keep audio cables away from mains power units and cables, thyristor dimmer units or computer equipment. Where this cannot be avoided, cross the cables at right angles to minimise interference.

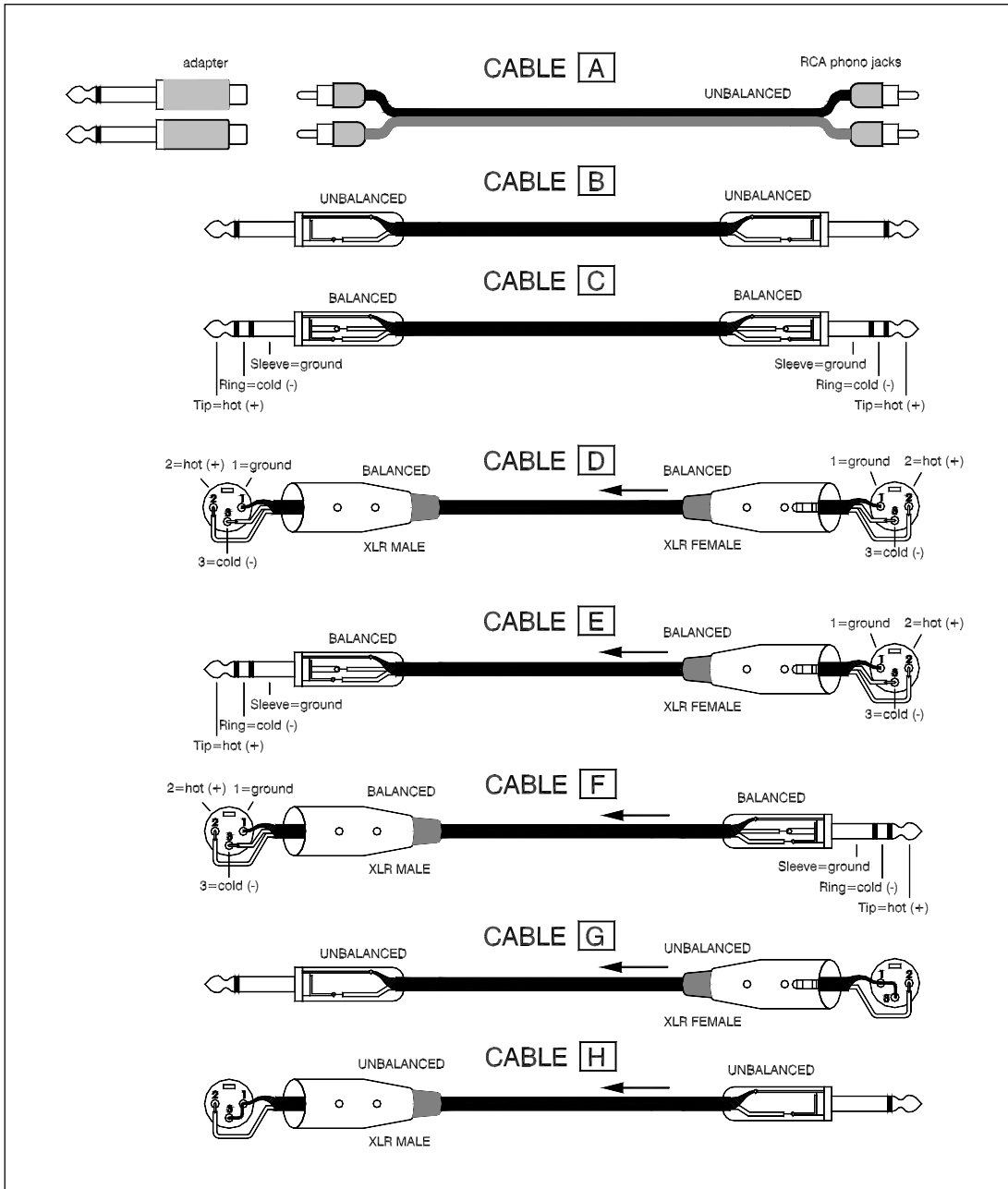
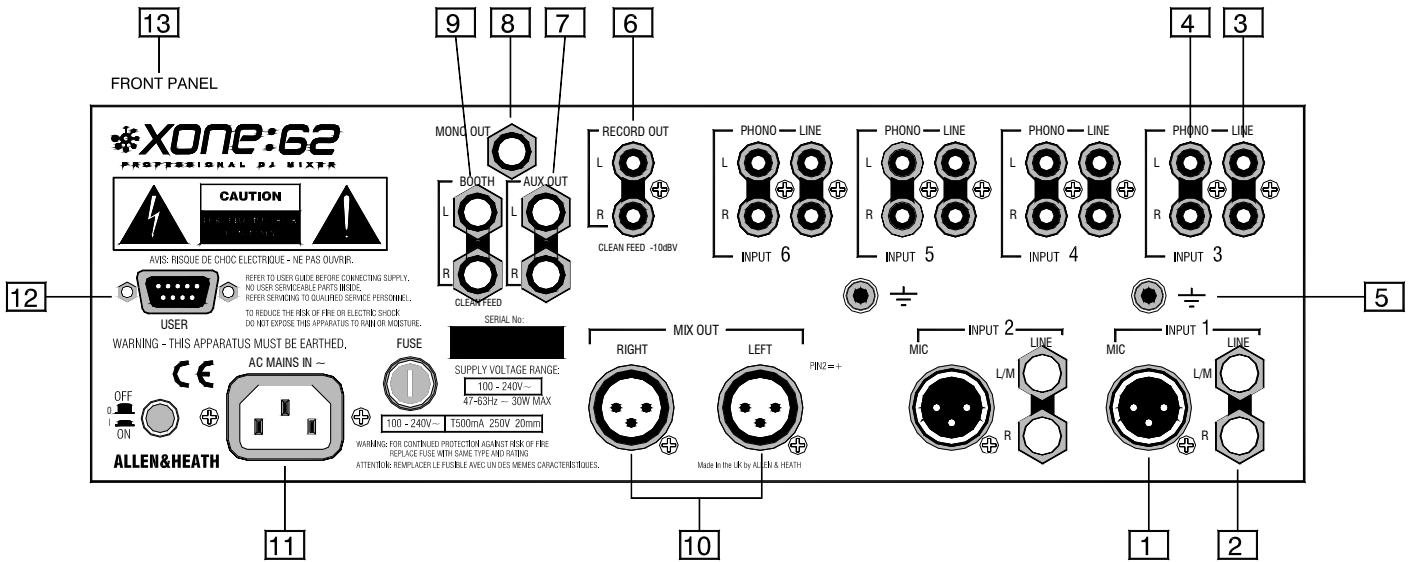

1 CH1-2 MIC input. Balanced XLR. Plug in a DJ, guest or announcement microphone here. Use good quality low impedance dynamic mics such as those specifically designed for vocals. Do not use high impedance or unbalanced microphones, or condenser types which require phantom power. Use professional grade balanced cables wired as CABLE **D**. Use the best cable and connectors you can afford as these are typically subject to intense use and abuse in the club environment.

2 CH1-2 LINE input. Unbalanced TRS jacks. Connect mono or stereo line level sources which do not need to route through the crossfader. For a mono source plug into the L/M input only. For a stereo source plug the left source into the L/M input, and right into the R input. These are 3-pole TRS sockets which can accept balanced or unbalanced TRS or TS jack sources. Depending on the source connector type, use CABLE **B** **C** **E** or **G**. To connect RCA phono jack sources you can use the standard CABLE **A** with RCA to jack adapters, or custom make as required.

3 CH3-6 LINE input. RCA phono. Connect stereo line level music sources such as CD, MD, DAT, drum machines, keyboards or other instruments. Do not connect turntables which require RIAA equalisation. Use CABLE **A**. Alternatively, you can connect to jack sources using this cable with RCA to jack adapters. Avoid using low grade cables such as those often supplied with domestic equipment as these can quickly prove unreliable in use.

4 CH3-6 PHONO input. RCA phono. Plug in turntables with magnetic cartridges requiring RIAA equalisation. For non-RIAA turntables plug into the LINE input instead. Do not plug in line level sources to the phono inputs as these will overload the preamp and cause severe high level distortion. Use high grade versions of CABLE **A**.

5 Chassis earth terminal. Two screw terminals are provided for connecting the earth straps from turntables. This connection earths the metal parts of the turntable to reduce hum, buzz or similar audible noise getting into the system.

6 RECORD output. RCA phono. This provides a music only output not affected by the main mix fader. Connect to a stereo recorder such as MD, DAT or cassette to record the show. Use CABLE **A** with or without adapters, or a custom cable, depending on the recorder connector type.

7 AUX output. Impedance balanced TRS jacks. Depending on the application of the Aux mix this stereo line level output can be used to feed samplers and other effects units, an additional monitor, zone or recorder. Connect to balanced or unbalanced equipment using CABLE **B** **C** **F** or **H**. To connect RCA phono jack sources you can use the standard CABLE **A** with RCA to jack adapters, or custom make as required.

8 MONO output. Impedance balanced TRS jack. This output sums the post-fader left and right mix signals to provide a feed to mono or sub bass amplifier systems, sound-to-light controllers and so on. Connect to balanced or unbalanced equipment using CABLE **B** **C** **F** or **H**.

9 BOOTH output. Impedance balanced TRS jacks. Provides a line level music only stereo feed to the DJ local monitor amplifier system. It is not affected by the master fader or cue system. Connect to balanced or unbalanced equipment using CABLE **B** **C** **F** or **H**.

10 MIX output. Balanced XLR. This is the main output that feeds the house PA system. Plug into the house processor/amplifier system using balanced CABLE **D** or **E**. It is not usual for unbalanced equipment to be used here.

11 AC MAINS input. IEC cable with moulded mains plug suitable for the local supply. Please refer to **Connecting Mains Power**.

12 USER connector. This 9-pin D-type female connector is not wired as standard. It is provided for custom wiring of special modifications that may be required for a specific application. This work, if required, should be planned and carried out by competent installation or service personnel.

13 HEADPHONES output. Stereo TRS jack. Plug in stereo headphones fitted with a stereo ¼" jack. Avoid using mini-jack to ¼" jack adapters as these can prove unreliable with continuous use. Use closed-ear headphones that provide maximum acoustic isolation when cueing your sources. We recommend that you use high quality headphones rated between 30 to 100 ohms impedance. 8 ohm headphones are not recommended.

 **WARNING** To avoid damage to your hearing do not drive headphones at high listening levels for long periods of time. Start with the level control set to minimum and raise it until a comfortable listening level is achieved.

Input Channel

These controls adjust the level and tone of each source before they are mixed. Six input channels are provided. Each has two inputs. CH 1 and 2 are used for microphone or alternative stereo line source. They provide corrective source equalisation. CH 3 to 6 are used for the turntables or alternative stereo music sources and can be routed through the crossfader and VCF effects stage. These provide effective equalisation to creatively shape the sound during performance.

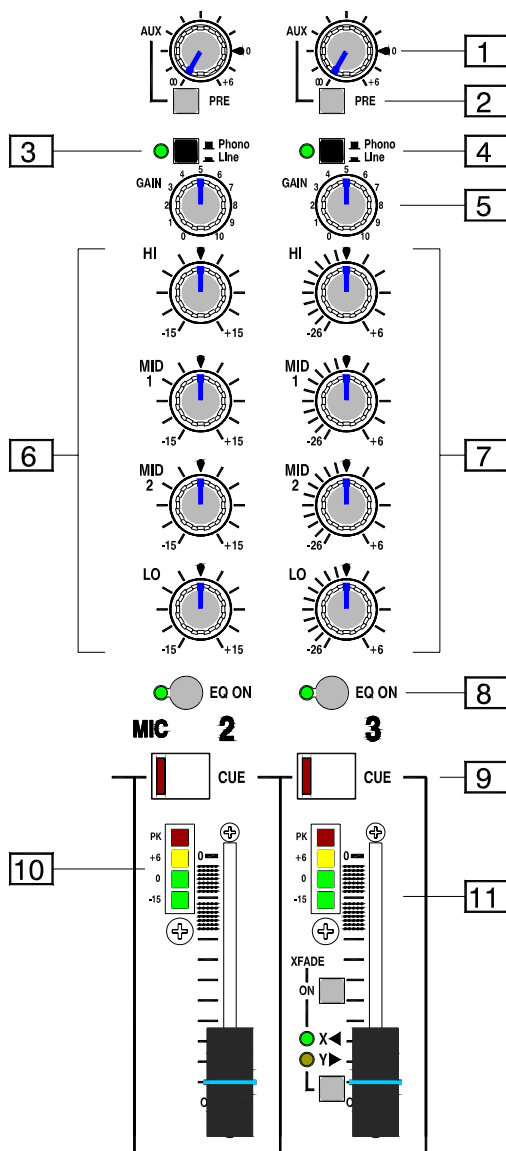

1 AUX send. Adjusts the level of the channel signal to the stereo Aux output. Turn fully anticlockwise to turn the signal off, fully clockwise for a maximum +6dB boost. The normal '0' position is marked.

2 PRE switch. With the switch in its up position the signal to the Aux mix is sourced post-fader. This means that the Aux send follows the channel fader movements. Press the switch to source the send pre-fader. Set in this way the fader has no affect on the Aux level.

Post-fade sends are typically used to send channel signals to effects devices such as reverb processors. The amount of signal sent to the device follows the fader level. The processed (wet) signal returned to the mix elsewhere is therefore in proportion to the direct (dry) signal regardless of fader position. This could, for example, be used to add ambience to the DJ or guest vocal mic.

Other post-fade uses include special recording or zone feeds. Note that the channel post-fade sends do not follow the crossfader setting. Use the XFADE Aux send instead if the level should be affected by the crossfader.

Pre-fade sends are typically used to feed monitor speakers such as stage foldback. Here, it is important that fader changes made to balance the house mix do not affect the monitor levels.

When working with a sampler effects device you could use either post or pre setting. If you wish to cue the sampler effect before raising the source fader into the mix then set it pre-fade. Use the sampler return channel fader to bring up or remove the effect from the mix.

☺ You can use the Aux mix to cue your music when beat or cut mixing. Set all sends pre-fade and select the headphones monitor AUX switch to listen to the selected channels. This lets you listen to the effect of mixing the sources or matching the beat before you bring it into the house mix.

3 MIC/LINE switch. CH1 and 2 are the 'MIC' channels. They can select either the XLR microphone input or the alternative jack stereo line input. In the up position MIC is selected, indicated by the green led. When pressed, LINE is selected, indicated by the led changing colour to red.

4 PHONO/LINE switch. CH3 to 6 are the 'MUSIC' channels. In the up position the switch selects the PHONO input, indicated by the green led. This input provides standard RIAA equalisation for high quality magnetic cartridge turntables. When pressed, LINE is selected, indicated by the led changing colour to red. Use this to select non-RIAA or alternative stereo music sources.

5 GAIN control. Adjusts the input sensitivity of the channel to match the connected source to the console 0dB operating level. This provides a 20dB range with continuous adjustment for line level signals from -10dBu to +10dBu, -40dBu to -20dBu for mics, or to match a wide range of RIAA turntable cartridges. Use the channel meter and Cue system to correctly set the gain.



Reduce GAIN if the channel meter red PK led flashes.

6 MIC EQ. The CH1 and 2 equaliser is different to the CH3-6 equaliser. It provides a powerful tool to adjust the tonal quality of the sound to correct source problems such as microphone characteristics, proximity effect, noise and feedback, or to adjust the overall 'feel'. Start with the EQ controls set to their mid (flat) position. Then adjust to achieve the desired sound. Take time to experiment with these controls.

The **XONE:62** equaliser provides separate tone control over four frequency bands. The frequencies in each band may be boosted or cut by up to 15dB. The centre flat position is detented for quick resetting.

HI Turn this control clockwise to boost and anticlockwise to cut the high (treble) frequencies. This has a shelving response with all frequencies above the 10kHz turning point affected. Note that frequencies below 10kHz are affected by a decreasing amount. Use HI boost to brighten up the sound by adding sparkle, and cut to reduce source hiss and ambient high frequency pickup, or to limit or lift the high response of vocal mics.

MID 1 Turn clockwise to boost and anticlockwise to cut the higher mid frequencies. This has a bell shaped peak/dip response that has maximum effect at 2.5kHz. Boosting can enhance the intelligibility of vocals. On the other hand, some situations may require cutting to notch out a ringing frequency so increasing gain before feedback.

MID 2 This is similar to MID 1 but affects the lower mid frequencies centred at 250Hz. Boosting can enhance the warmth of the sound while cutting can reduce the unpleasant resonant or boomy effects.

LO This is similar to the shelving HI control but affects the low (bass) frequencies below the 100Hz turning point. Note that frequencies above 100Hz are affected but by a decreasing amount. Use LO boost to enhance low end punch, or cut to reduce source hum and rumble, or to remove the bassy sound of vocal mic proximity effect.

7 MUSIC EQ. CH3-6 feature a unique four band equaliser similar to CH1 and 2 but providing a very different function. While the centre frequencies are the same, The range of boost and cut is different to better suit music mixing. This provides the DJ with effective equalisation to creatively alter and shape the sound during live performance rather than simply correct source problems. Pre-recorded music does not usually need corrective EQ. This type of equaliser is known as 'asymmetric' because the amount of boost and cut is not the same. Boost is restricted to a safe +6dB to highlight selected sounds while preventing system overload through heavy use. Cut on the other hand, is increased to a huge -26dB to completely suck out affected frequencies dramatically changing the effect. Use cut rather than boost to create your dramatic performance effects.

8 EQ ON switch. For CH1 and 2 use this to compare the original and equalised sound. For CH3-6 use this to punch the performance effect in and out. The switch illuminates when the EQ is on.

9 CUE switch. Press this large switch to listen to the pre-fader channel signal in the headphones and to display its signal on the main meters. This does not affect the house mix or booth speakers and lets you audition the signal to cue a track before adding it to the mix. Cue is post-EQ for mic but pre-EQ for music channels so that you do not lose your reference when beat mixing, regardless of the EQ effect. The switch cap illuminates so that you can see at a glance which channel is cued.

10 Channel meter. A 4 led meter bar always shows the presence of the pre-fader channel signal. Adjust the gain control for normal music averaging 0dB with loudest moments reaching +6. Reduce the gain if the red PK led flashes.

11 Channel fader. A 60mm stereo fader adjusts the signal level from off to the normal '0' top position. This allows smooth fade ins and a visual indication of its contribution to the mix. The fader does not affect the pre-fade Aux sends.

Crossfader and VCF

The crossfader is the one feature that instantly sets the DJ mixer apart from a conventional mixer. It is applied to the stereo music channels and lets you smoothly fade from one track into another using a single fader. It is also used as a creative performance tool to layer or interact between two sounds when cut or scratch mixing. It is fully assignable from each music channel and can be easily replaced if it becomes damaged or worn through exceptional mechanical operation. The high quality Penny & Giles type is used on the model.

The **XONE:62** is unique in being the first DJ mixer to include an analogue voltage controlled filter (VCF) section. These filters provide live performance tools far more powerful than any equaliser or kill switch. They produce the same warm analog resonant frequency sweeping sound as made popular by well known classic analogue synthesisers, but using the latest high performance technology for quiet, stable operation.

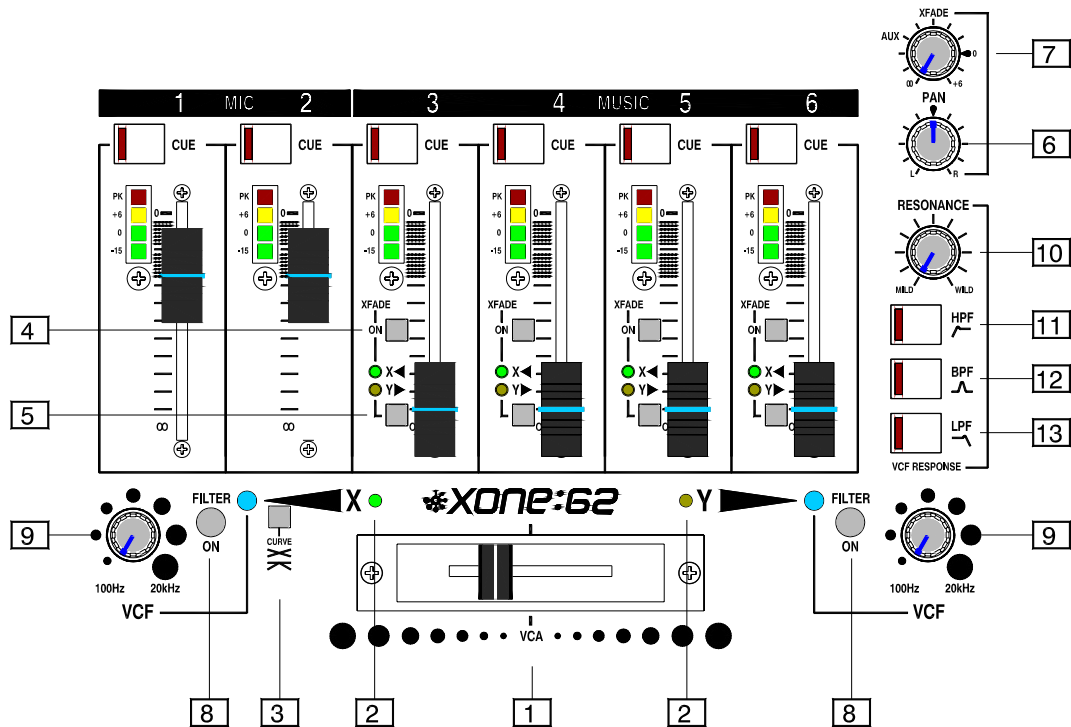

1 VCA Crossfader. The XONE:62 uses four high performance voltage controlled amplifiers (VCA), a pair for each side of the stereo crossfader. The robust 45mm fader produces a DC control voltage which determines the signal level of the VCAs. The voltage is filtered to prevent any audible noise, clicks or scratchiness resulting should the fader track become worn. This benefit would not be possible if the signal were routed through a conventional audio fader.

2 XY Indicators. A colour coded led above each side of the crossfader helps you visually check which channel is routed to which side, green for X, yellow for Y.

3 Crossfader Curve. The VCA system allows that the fader law (curve) to be easily changed to suit the style of mixing. Set the tamperproof underpanel CURVE switch to the position required. Two standard curves are available. Experiment with both to understand their effect on the sound:

Dip Curve With the switch in its normal up position each signal is attenuated by 6dB in the middle position. This means that there is no overall change in level as the two similar signals mix, ideal for seamless beat mixing when fading smoothly from one track to another.

Cut Curve When the switch is pressed each signal has no attenuation in the middle position. Attenuation starts as the fader moves beyond the middle. This gives a more dramatic response better suited to cut or scratch mixing, layering different sounds, or to emphasis a mix.

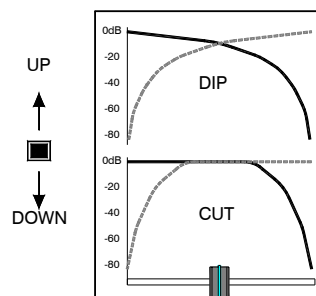

4 **XFADE ON.** In the up position the music signal is routed directly to the mix. Press to route the signal through the crossfader.

5 **XY.** To route to the left (X) side make sure the switch is in its up position. Press to route to the right (Y) side. Either the green X led or yellow Y led lights to show which side is routed. Both leds are off if the signal is not routed through the crossfader.

6 **XFADE PAN.** Adjust to change the balance between the left and right crossfader output signals. Use this to correct an imbalance in the stereo output, or as a dynamic performance effect. For normal performance make sure the PAN control is in its detented centre position.

7 **XFADE to AUX send.** This controls sends the output of the crossfader to the stereo Aux mix. For example, you could send the DJ music mix to a monitor, zone, effect or special recording feed.

Replacing the Crossfader

The crossfader on a DJ mixer is heavily used and can suffer considerable wear and tear. The audio design using VCAs prevents clicks and scratchiness as the fader wears. However, the movement can become mechanically stiff or sloppy in time, or become ingrained with dirt. Should this be the case the fader may need replacement.

The **XONE:62** crossfader is removable and can easily be replaced in a few minutes. Make sure you order the correct Penny & Giles version from your Allen & Heath dealer: XONE2:XFADER

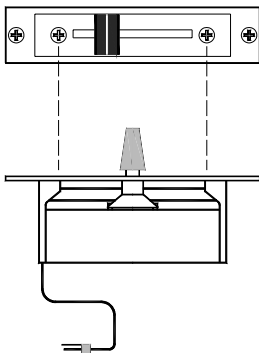

Use a medium size cross-point (Pozidriv) screwdriver to undo and remove the two outer screws on the crossfader plate. Do not remove the inner screws. Lift the crossfader assembly up and away from the console panel. Unplug the cable from the old crossfader and plug in the new assembly. Check that the connector is correctly aligned and pushed on. Replace the assembly making sure the cable faces the left side of the console. Refit the screws and test operation.

The VCF Filters

A **voltage controlled filter** is an audio filter whose cut-off frequency is altered by a DC control voltage rather than a variable resistor. This produces a much wider operating range and more control over the filter response to create unlimited combinations of tonal effect.

Each X and Y side of the crossfader is provided with its own stereo VCF. Each can be switched in or out, and each has its own frequency sweep control. The filter type and resonance effect are globally selected affecting both filters simultaneously.

8 **FILTER ON switch.** Each X and Y filter has its own ON switch. The blue led lights when the filter is switched on. The signal is not affected by the filter if the switch is in its off position. Use this to punch the filter effect in or out.

9 **VCF SWEEP control.** Each X and Y filter has its own frequency sweep control to adjust the cut-off point anywhere from low to high frequency. Rotating the control during performance produces the dynamic sweeping effects desired by performing DJs. These large soft touch controls are positioned either side of the crossfader for convenient live operation. Separate controls for X and Y mean that the effect can be applied to each track independently and faded in as the crossfader is operated. Note that the filter type and resonance setting apply to both filters and are not independently controlled.

10 **RESONANCE control.** Adjust this to change the 'Q' or 'sharpness' of the filters. This affects how they respond around the cut-off frequency. At the minimum MILD setting the filters have a gentle roll-off 'knee' giving a subtle, smooth response. At the clockwise WILD setting they produce a resonant feedback boost around cut-off resulting in some very dramatic performance effects. The sound varies according to the filter type selected. To avoid unexpected results it is best to start experimenting with RESONANCE set to a low position.

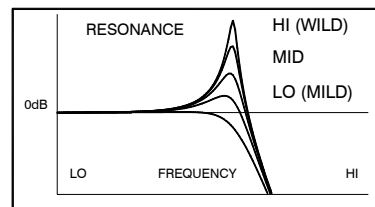

High RESONANCE settings can result in significant boost of selected frequencies. Reduce the channel GAIN if the signal levels increase enough to light the red PK leds in the output meters. Failure to do this may result in system overload and distortion.

Filter Type Select

The filters are 'state variable'. This means that they provide three simultaneous filter types, high-pass, band-pass and low-pass. Three large illuminated switches select which type is active. You can press any combination together to create different response types such as 'notch' and an interesting 'all-pass' effect. The switches are 'soft switched' for live performance, meaning that the audio signal is ramped between filter states to prevent audible clicks. The selected type affects both X and Y filters.

Note that the last selected type is lost when power is removed from the console. The LPF is always selected when power is applied.

The graphs below show the effect on the audio frequency response for the three filter types. The range of sweep from low to high frequency is shown together with the effect of adjusting RESONANCE (one frequency with several resonance settings shown).

The vertical scale shows the amount of cut or boost around the normal 0dB operating level. The horizontal scale shows the change in frequency from low (bass) to high (treble).

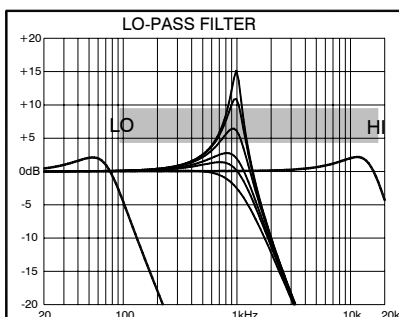
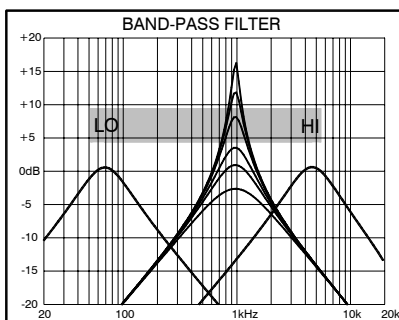
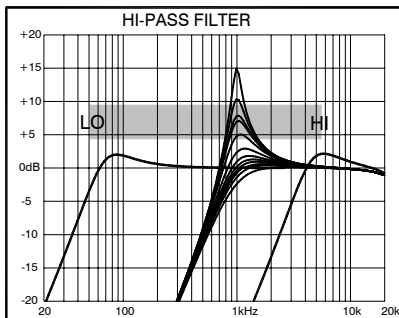

11 HPF. Press this switch to select the high-pass filter. Frequencies below the cut-off point are removed. The cut-off point is adjusted using the large VCF control. At minimum little effect is heard as only sub bass frequencies are removed. Sweep clockwise to gradually remove the bass line followed by the higher frequencies. The highest frequency is limited to 10kHz as little useful material is heard beyond this.

Tip. Try switching the HPF in with VCF set fully clockwise at highest frequency, then gradually sweeping the frequency back to minimum. This can create an atmosphere of anticipation as the dance floor awaits the power of the beat to kick in.

12 BPF. Press this switch to select the band-pass filter. Frequencies above and below the cut-off point are removed leaving just a narrow band of sound. Sweep VCF around its mid position to affect lead sounds such as keyboard and vocals.

Tip. Try picking out individual sounds such as vocals and mixing them into the beat and bass of the opposite track to create a whole new mix. Add a little resonance to the BPF to lift the sound out of the mix.

13 LPF. Press this switch to select the low-pass filter. Frequencies above the cut-off point are removed. The cut-off point is adjusted using the VCF control. At minimum only sub bass remains. Sweep clockwise to gradually introduce the bass line followed by higher frequencies into the mix.

Tip. Try sweeping the LPF back to a low setting to keep the beat and energy going while talking over the mix. Try also punching in the filter and sweeping it back from high to low in time with the beat. Punch it out at the start of the next bar.

In addition to the three basic filter types you can experiment with new effects by selecting combinations of switches together. Press and release the switches together. They illuminate to show which filter types are active. For example:

HPF+LPF = NOTCH. Used with low settings of RESONANCE you get a phasing effect. Try sweeping the effect across the frequency range.

HPF+BPF+LPF = ALL PASS. A surprising effect considering that all frequencies are 'passed'. However, the filter type interaction around the cut-off point creates an interesting effect that varies from subtle to dramatic depending on the RESONANCE setting.

Tip. Take some time to experiment with the filters before 'going live'

Master Mix and Monitor System

The **XONE:62** provides a stereo main mix output with fader control and balanced XLR connections to drive the house PA amplifier system. It also provides a mono output that sums the left and right mix signals to feed an additional mono zone, sub bass or sound-to-light controller. You can make a music only recording by connecting to the independent record output. Full DJ monitoring facilities are available with independent headphones and booth monitors, together with stereo metering system. Every signal can be checked individually or within any mix, ideal for system setup and performance cueing. Facilities such as Mono and Split-Cue switching are well suited to the way the professional DJ works.

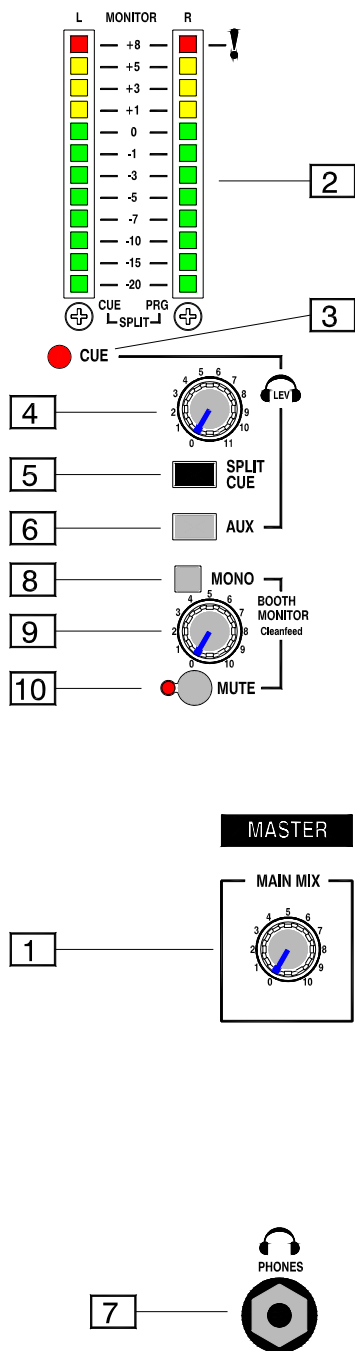

1 MIX MASTER. A rotary master control adjusts the output level feeding the house PA. This is a stereo control which adjusts the left and right signals at the same time. It affects the stereo mix and mono outputs. Note that it does not affect the record and booth outputs. The maximum position represents unity (0dB) gain. If you find yourself normally setting the control in the lower part of its travel then the connected equipment may be too sensitive for the operating level of the console. With the control set to its maximum position adjust the input level trim of connected equipment for the loudest level allowed.

⚠ In a club or similar installation strict sound level and noise regulations may apply. Check that your system levels are set up to comply.

2 MIX / MONITOR METERS. A pair of meter bars displays the level of the selected headphones monitor source in. This is either the main mix, the Aux mix or Cue. When SPLIT CUE is selected the left meter displays the active CUE signal, the right displays PRG (program), both in mono.

Each meter has 12 leds to indicate signal levels from a low -20dB. Green and yellow leds indicate normal operating levels. The top red led lights at +8dB still providing a healthy 13dB before clipping. Meter '0' represents +4dBu at the XLR outputs. The meters are peak responding with a fast attack and are therefore able to display fast transients accurately. The top five leds are 'peak hold' which means that the highest remains lit for a short time after the signal has gone. This makes it easier to keep track of the highest levels.

3 CUE indicator. A large red led lights when a channel CUE is active. This indicates that the selected channel CUE signal is heard in the headphones and displayed on the monitor meters. It is important to use CUE to set the channel gains correctly to maintain the wide dynamic range achievable with this console. Reduce the gain if the red PK leds flash.

4 HEADPHONES level control. Adjusts the level of the signal in the stereo headphones. This does not affect the level of the local monitor.



WARNING Some headphones are more sensitive than others and can produce higher output levels. To avoid damage to your hearing start with the level control at minimum and turn up only as much as is needed to maintain comfortable listening level. Do not drive headphones at high listening levels for long periods of time.

5 SPLIT-CUE switch. Press this switch to change the way CUE operates. Normally, pressing a channel CUE switch overrides both left and right monitor program signals with the stereo cue signal. With the switch pressed, CUE overrides just the left channel leaving the program in the right channel. The left monitor meter displays the cue signal, right displays program. This is invaluable in club mixing where the main program should remain audible while cueing other channels ready to bring them into the mix. It is very useful when beat mixing using headphones. Note that Cue does not affect the main output or booth monitor.

6 AUX switch. In the normal up position the headphones and meters monitor the post-fade main mix. Press the switch to select the stereo Aux mix as the headphones monitor source. Note that this does not affect the main output or booth monitor.

 **Tip.** Use split-CUE to match the beat between two tracks when beat mixing, or check the effect before cut mixing. Alternatively, you can select Aux and raise the sends on the two channels to give you a pre-fade stereo **PREVIEW** of the mix which does not affect the main output. In this way you can hear exactly how it will sound in the main mix before you raise the channel faders or flip the crossfader. Use the Aux send controls as your preview faders. Pressing any CUE switch will override the preview.

7 HEADPHONES OUTPUT. This output is positioned on the front panel so that the DJ can plug in his favourite headphones without needing access to the rear connector panel. Headphones are available in many different styles, impedances and volume ratings. To get the best from your system we recommend that you use high quality closed-ear headphones in the range 30 to 100 ohms. 8 Ohm headphones are not recommended. Avoid using mini-jack to 1/4" jack adapters as these may quickly prove unreliable.

The HEADPHONES Monitor

The DJ uses the headphones to check the mic and music sources and to cue tracks ready to bring them into the mix. The headphones isolates the dance floor sound from the DJ and also prevents the audience hearing the monitor.

The BOOTH Monitor

The DJ uses the booth monitor to reinforce the music level in his booth so that he can 'feel' and interact with the beat. This provides an independent music only monitor that is not affected by the main Mix master control. It is also not affected by the Aux or Cue monitor sources. To avoid acoustic feedback the microphone signals are not routed to the booth monitor.

8 MONO switch. Sums the left and right monitor signals together so that the selected stereo source can be checked in mono. Use this to check for mono compatibility and phase problems, especially important in dance floor and recording applications. A drop in level or loss of low frequencies when pressed indicates reversed phase between the left and right signals. Alternatively, you can select this if you wish to run the booth monitor in mono rather than stereo. Note that the MONO switch does not affect the headphones monitor.

9 BOOTH MONITOR level control. Adjusts the level of the signal to the stereo booth monitor output. This does not affect the level in the headphones.

10 MUTE switch. Press to mute the booth monitor output. The switch cap lights when the monitor is muted. The headphones and main output are not affected. This is useful when the DJ chooses to work with headphones only, check the sound level from the dance floor, or quieten the monitor to talk to staff or take a request.

Glossary

The following section is included to help you understand some of the technical terms and jargon referred to with consoles of this type. It is by no means a complete reference. Please refer to specialist audio publications should you wish to know more.

Amplitude Another term used for signal level.

Asymmetric EQ An equaliser with a different amount of cut and boost of the frequency bands. This is used to restrict the available boost so preventing system overload while providing extended cut to allow dramatic performance effects by 'killing' selected frequencies.

Attenuate Reduce the signal level.

Aux Auxiliary. An independent mix derived from the channels for various functions. This can be set pre (before) or post (after) the channel fader. Pre-fade sends are often used for foldback monitors or DJ sampler effects feeds. Post-fade sends are often used for reverb effects, zone and special recording feeds.

Balanced, Unbalanced Refers to the type of input or output signal connection. An unbalanced connection has two signal carrying conductors, one of which is the cable shield. A balanced connection has three conductors, two for signal and a shield which is connected to earth. Because the signal conductors are at the same impedance and of opposite polarity they are better able to cancel and therefore reject interference and noise pickup. It is standard practice to use balanced connections for long cable runs, for example to amplifiers, or cables carrying sensitive or low level signals, for example microphones.

Bandpass A filter with a bell-shaped response for attenuation of frequencies either side of the centre frequency.

Beat Mixing Using the variable pitch controls on turntables/CD players to synchronise the rhythm track of two separate songs, so that the beat remains constant when smoothly cross-fading from one to the other.

Bi-amping Providing separate amplifiers to drive the high and low frequency units in a loudspeaker. This requires a crossover processor that splits the frequency band into low and high. Bi-amping usually produces a cleaner and more controllable sound in larger systems.

BPM Beats Per Minute. The measurement of the rhythmic beat of the music.

Booth The area, often enclosed, where the DJ operates. Usually provided with local booth monitor loudspeakers.

Cardiod The response of a microphone which is more sensitive in front than behind. This is

generally used for vocal miking to reduce acoustic feedback.

Cut Mixing Moving the cross-fade control sharply from one side to the other, to either pick out a sound, a hi-hat, kick drum etc, or to drop straight into another record. Also known as chopping.

Cartridge The pickup in a turntable. Uses a needle to pick up vibrations from the record (vinyl) and convert this to electrical signals that feed the console. The cartridge is usually fitted to a removable headshell that plugs into the turntable arm.

Clipping The harsh distorted sound that results when the signal hits the maximum level possible. This is set by the power rail voltage. Above this there is simply no more voltage available so the signal is 'clipped'.

Compact Disc (CD) Well established stereo player using digitally mastered pre-recorded flat discs. Becoming popular with DJs as a replacement or alternative to vinyl mixing. Recordable CDs are now available.

Crossfader A short horizontally mounted fader for smoothly fading one music track in while fading the other out. Often used by the DJ for cutting and layering sounds while mixing.

Cue A monitor system provided for the DJ or console operator to check individual channel signals using headphones while lining up tracks ready to introduce into the mix. This does not affect the main console outputs.

DAT Digital Audio Tape. A type of digital 2 track recorder that uses a small tape cartridge to produce high quality recordings in a compact format.

dB Decibel. The unit of measurement for audio signal level. This is logarithmic to follow the response of the human ear. 'dB' is a relative measurement to compare one level with another, for example gain from input to output. 'dBu' is an absolute measurement referenced to a voltage standard where 0dBu = 0.775V rms. The console main outputs operate at the professional 'high' standard of +4dBu (1.23V) = '0' reading on the meters. "dBV" is a similar measurement but refers to a 1V standard. It is common for consumer equipment to operate at the 'low' standard of -10dBV (316mV). 'dBA' refers to sound pressure level and is measured using the 'A' scale that 'hears' in the same way as the human ear.

DJ Disc Jockey. The console operator sequencing and playing the music tracks. Some simply play the tracks, others talk over with introductions and announcements, and others provide an entertaining performance by mixing and shaping sounds to create a completely different musical experience.

Drum Machine An electronic drum simulator as used by keyboard players and in electronic music. This now provides another DJ tool to create an alternative beat to mix in with the music.

Dynamic Range The difference expressed in dB between the highest and lowest signal levels possible. This is limited by the clipping level and residual noise floor respectively.

Earth Also known as 'ground'. The term for the electronic signal reference. This connects to the mains supply earth point and all cable shields and conductive equipment cases. It provides the return for the signal voltage within the equipment. It also ensures operator safety by removing the possibility of electric shock should the mains voltage touch any metal part.

Earth Loop The result when the equipment sees more than one path to the system earth. Current flows because a resistive loop susceptible to radio and mains interference is formed. This can result in audible hum or buzz in the system.

Equaliser (EQ) This provides cut or boost of selected frequencies (equalisation) for tonal shaping of the sound. This is similar to the bass and treble controls of domestic hifi amplifiers. However, **XONE** provides 4 independently controllable frequency bands for corrective or effective sound shaping.

Feedback Also known as 'howlround' or 'ringing' this is the rapidly increasing tone produced when a microphone picks up its own signal from the speakers. It is usually a shrill and annoying squeal that should be quickly dealt with by reducing mic gain or equalising the system to notch out the offending frequencies.

Gain This is the boost or attenuation applied to the source signal in the channel preamp stage to match it to the console operating level. For example, a large amount of gain is needed to match low microphone signals. It is set using the console meters. Gain is not used for level (volume) control.

Headroom The amount of level available expressed in dB to handle peaks above the normal 0dB operating level.

Hz Hertz. The measurement of frequency. The audio spectrum ranges from a low (bass) frequency of 20Hz to a high (treble) 20kHz. Not many sound systems reproduce the full range. Average hearing does not extend much beyond 15kHz or so. Response is further impaired if the ear is subjected to continual high sound pressure levels.

Highpass A filter that attenuates frequencies below the cut-off frequency.

Hum Apart from not knowing the words... this is the audible noise that usually results from mains interference pickup, earth loops, bad interconnections and induced power supply and lighting fields. It is usually at mains frequency (50/60Hz) or a related harmonic.

Impedance (Z) A technical term for the resistance of a signal conductor to ground. Low impedance usually refers to microphones of 200 ohms or less, and line signals typically less than 100 ohms. Low Z sources are less prone to interference pickup. Inputs are usually high impedance so that one source can connect to more than one channel without signal loss. Note that the operating impedance of a connection is set by the impedance of the source, not that of the unconnected input.

Impedance balanced Refers to the type of output signal connection. Has three conductors, two for signal and a shield which is connected to earth. Provides interference rejection similar to a fully balanced connection because the two signal conductors are matched at the same impedance. However, the drive capability is less because the signal is carried by only one conductor.

Limiter A signal processor that limits the maximum level possible by preventing the signal going over a predetermined threshold level. This is very useful in club installations where it is inserted between the console and house system amplifiers to prevent the DJ exceeding the maximum allowable volume.

Lowpass A filter that attenuates frequencies above the cut-off frequency.

MC Master of Ceremonies. The presenter who introduces the performances and maintains the running order.

MiniDisc A type of low cost digital 2-track recorder that uses a disc similar to but smaller than that used by computers. It records up to 74 minutes of stereo material and is regarded as the modern replacement for the audio cassette recorder. It has the added facility to label and edit tracks.

Mono The left and right stereo signals summed together as one.

Mute To turn off the signal.

Noise Generic term for an unwanted signal. This may be residual electronic hiss, hum, buzz, clicks and pops, or simply loud undesirable music.

Noise Floor This is the term for the residual electronic noise produced by all powered audio equipment. It usually sounds like a constant hiss, although some equipment may suffer from residual hum as well.

Omni-directional The response of a microphone which picks up sounds equally all round. Not suited to live vocal applications as they are more prone to feed back.

Pan Panoramic. A control that adjusts the balance of the signal in the left and right speakers.

Peak Meter A type of signal meter that has a very fast attack and slower release. This picks up the fast signal transients and holds them long enough for the operator to see the activity on the display. These meters typically use led (light emitting diode) displays.

Phantom Power The DC voltage required by certain microphones to power the capsule. These are usually sensitive studio grade mics not suited to DJ mixing. The power is provided by the console using the two signal conductors in the balanced connection. There is no provision on **XONE** for this type of microphone.

Phono Abbreviation for phonograph as in 'turntable'. Usually means RIAA equipped input when marked on console inputs. Can also refer to the RCA 'phono' type pin jack connector found on turntables, CDs and much domestic equipment.

Polarity Sometimes referred to as 'phase' this is the + / - sense of a balanced signal or loudspeaker connection. Reversed polarity should be avoided and checked for as it can cause uncomfortable phasing effects between speakers.

Resonance Applied to the filters this is the effect of accentuating frequencies around the cut-off point to produce subtle or dramatic phasing effects.

RIAA Record Industry of America Association, responsible for the long established equalisation standard that is applied to the signal produced by a turntable cartridge. Due to the physics of vinyl reproduction the needle produces a reasonable high frequency signal but much less low frequency. An RIAA pre-amplifier compensates for this by inversely attenuating the high and boosting the low frequencies.

Reverberation The way in which sound reflects and bounces around the room after the source is removed. This depends on the size and shape of the room as well as the materials such as carpets, curtains and clothing that absorb certain frequencies.

Reverb Effect This is a signal processor that connects to the console to artificially simulate the reverb effect. Parameters such as decay time, diffusion and amount of reverb can be controlled. Typically selected sounds are sent to the processor by turning up the channel post-fade aux sends. The processed (wet) signal is returned to the mix through a channel where it adds to the direct (dry) signal routed from the channel fader.

RPM Revolutions Per Minute. The measurement of turntable speed.

Sampler Another performance effect popular with DJs. The channel signal is sent to a digital

processor that samples (stores) a short duration of sound. The output is returned through a channel and replayed by pressing a trigger. Many samplers provide creative effects such as repeat and reverse.

Scratch Mixing The art of rhythmically rocking a record back and forward on a turntable, to repeat a certain sound, a vocal or tone, at the same time operating the cross-fader to create a syncopated "wah wah" chirp added over a bass heavy back beat.

Signal-to-Noise Ratio (SN) This is the difference expressed in dB between the normal 0dB operating level and the residual noise floor. It represents how far above the equipment hiss level the signal operates. More is better.

Slipmat A fabric turntable mat positioned under the record so that the DJ can hold it stationary ready to let go for a fast start at the point cued.

Sound-to-Light A processor that converts an audio signal into a control voltage that triggers lighting effects. This produces the popular disco effects with lights flashing in time to the beat.

Split Cue A facility to listen to the cue signal in one ear while keeping the program in the other. Used for matching the beat while cueing a new track.

Sub Bass A loudspeaker designed to reproduce only very low frequency sound, typically from around 50 to 120Hz. A crossover is used to route only the low frequencies to the sub.

TRS Jack Refers to the 3-pole (stereo) ¼" jack plug with Tip, Ring and Sleeve connections.

Turntable Otherwise known as a 'record deck' this plays vinyl discs, still the most popular source for DJ mixing. It is common for the cartridge to plug directly into the mixing console 'phono' input which provides the RIAA equalisation required. The turntable usually has variable speed control so that the DJ can synchronise the beat between tracks.

VCA Voltage Controlled Amplifier. An audio gain element whose level is controlled by a remote DC voltage rather than through a fader or rotary control.

VCA Crossfader Functions as an audio crossfader but with the audio level controlled by a DC voltage produced by the fader. This voltage can be electronically filtered and is therefore able to remove the clicks, scratches and drop-outs associated with worn audio faders.

VCF Voltage Controlled Filter. An audio filter whose cut-off frequency is controlled by a remote DC voltage rather than a rotary or switched control. This provides greater range and capability.

XLR The professional standard 3 pin round connector used for microphone and other balanced connections. Equipment female sockets are for inputs, male for outputs.

Tips and Troubleshooting



For your safety do not remove the **EARTH** (ground) connection in the power lead of the console or connected equipment.



Have your **MAINS SYSTEM** checked by a qualified electrician. If the earthing is solid to start with you are less likely to experience problems.



Use high grade **AUDIO CABLES** and check them for reliable connection. It is well known that many audio system problems are due to faulty cables and connectors.



In a club or similar installation strict **SOUND LEVEL** and noise regulations may apply. Check that your system levels are correctly set up to comply.



To avoid damage to your hearing start with the **HEADPHONES** level control at minimum and turn up only as much as is needed to maintain comfortable listening level. Do not drive headphones at high listening levels for long periods of time.



Always switch connected **AMPLIFIERS** on last and off first to avoid thumps when the console and connected equipment is turned on or off.



Reduce gain if the red meter **PEAK** led flashes. These warn you that you are near clipping which may result in system overload and distortion. The **XONE:62** provides plenty of drive and headroom when operated around the 0 to +6 meter points. Check that the amplifier / speaker system is correctly matched and set up for correct levels.



Increasing **VCF RESONANCE** boosts a narrow band of selected frequencies. Make sure you reduce the channel gain if the red peak meters start to flash. It is best to start experimenting with this control set to minimum.



If you suspect a console fault. The console is the heart of the audio system and is often suspected faulty when a problem occurs. Usually the fault is found to be with other equipment in the system, typically the interconnecting leads, input sources, or level matching between equipment. Check for source problems by unplugging each channel in turn listening for a change in symptom. To check the console, isolate it by unplugging all sources and outputs leaving just headphones and a reference source such as a CD player connected.



I have plugged in a microphone but it does not work. The **XONE:62** is designed to operate with non-phantom powered dynamic microphones such as the popular vocal types. Do not use microphones which require phantom power.



The stereo channel sounds very distorted with high level and excessive bass. Only plug turntables needing RIAA equalisation into CH 3-6 PHONO inputs. Other equipment should be plugged into the LINE inputs.



There is a hum on the turntable channels. Check that the turntable earth strap has been correctly connected to the console chassis earth post. Also check that the turntable headshell and cartridge are correctly aligned and plugged in.



Only one side of the stereo mix is working. Check that the XFADE PAN control is not set fully to either L or R. Also check for bad connections, in particular turntable headshell and cartridge pins.



There is feedback. Check that the microphone is not placed next to the headphones. The mic may pick up its own signal from the headphones and feed back. In loud listening conditions feedback can sometimes be caused by mechanical vibration through the turntables into the cartridge, or even the needle resting on a cued turntable starting to resonate in the groove of the record.



When the VCF is switched on there is very little sound. Operate the VCF frequency control to restore the frequency content of the sound.



There is no monitor output. Check that a channel CUE switch is not already selected. This is indicated by the red CUE led under the monitor meters. Also check that AUX is not selected.



There is no stereo channel signal. Check that the input selector switch is correctly set.



The crossfader is not working. Make sure the channel XFADE ON switch is pressed and X or Y correctly selected.



The crossfader works backwards. Check that it has been re-fitted the right way round if previously removed.



I have connected a stereo source to a single input using a Y-adaptor but it sounds bad. Do not connect more than one output to the input. These adaptors are designed to feed one output to two inputs, not the other way round.