

ALLEN & HEATH



USER GUIDE

Publication AP7236

Limited One Year Warranty

This product is warranted to be free from defects in materials or workmanship for period of one year from the date of purchase by the original owner.

To ensure a high level of performance and reliability for which this equipment has been designed and manufactured, read this User Guide before operating. In the event of a failure, notify and return the defective unit to ALLEN & HEATH Limited or its authorised agent as soon as possible for repair under warranty subject to the following conditions

Conditions Of Warranty

The equipment has been installed and operated in accordance with the instructions in this User Guide.

The equipment has not been subject to misuse either intended or accidental, neglect, or alteration other than as described in the User Guide or Service Manual, or approved by ALLEN & HEATH.

Any necessary adjustment, alteration or repair has been carried out by ALLEN & HEATH or its authorised agent.

This warranty does not cover fader wear and tear.

The defective unit is to be returned carriage prepaid to ALLEN & HEATH or its authorised agent with proof of purchase.

Units returned should be packed to avoid transit damage.

In certain territories the terms may vary. Check with your ALLEN & HEATH agent for any additional warranty which may apply.

Restrictions: Software in this product is confidential copyrighted information of TCAT and Allen & Heath and title is retained by TCAT and/or its licensors. The customer shall not modify, decompile, disassemble, decrypt, extract or otherwise reverse engineer the software. Please read the End User Licence Agreement on Allen & Heath's website for the use of software in and to support this product.

Export Regulations: Software, including technical data, is subject to U.S. export control laws, including the U.S. Export Administration Act and its associated regulations, and may be subject to export or import regulations in other countries. The Customer agrees to comply strictly with all such regulations and acknowledges that it has the responsibility to obtain licenses to export, re-export, or import software.

This product complies with the European Electro magnetic Compatibility directives 89/336/EEC & 92/31/EEC and the European Low Voltage Directives 73/23/EEC & 93/68/EEC.

This product has been tested to EN55103 Parts 1 & 2 1996 for use in Environments E1, E2, E3, and E4 to demonstrate compliance with the protection requirements in the European EMC directive 89/336/EEC. During some tests the specified performance figures of the product were affected. This is considered permissible and the product has been passed as acceptable for its intended use. Allen & Heath has a strict policy of ensuring all products are tested to the latest safety and EMC standards. Customers requiring more information about EMC and safety issues can contact Allen & Heath.

NOTE: Any changes or modifications to the console not approved by Allen & Heath could void the compliance of the console and therefore the users authority to operate it.

ZED-R16 User Guide AP7236 Issue 2

Copyright © 2008 Allen & Heath Limited. All rights reserved

Allen & Heath Limited

Kernick Industrial Estate, Penryn, Cornwall, TR10 9LU, UK

<http://www.allen-heath.com>

PACKED ITEMS

Check that you have received the following:

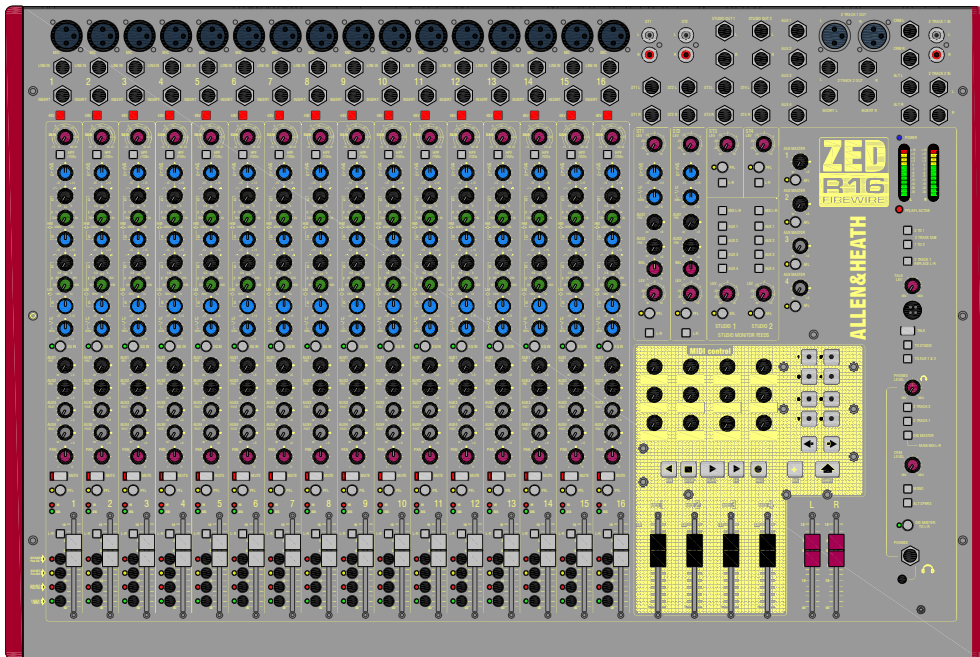

ZED-R16 MIXER

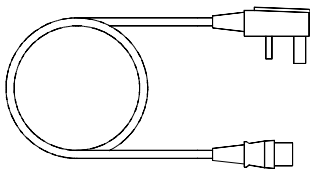

Mains Lead

Check that the correct mains plug is fitted.

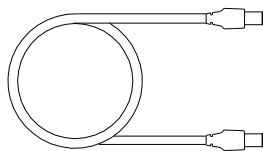

6 pin to 6 pin FireWire cable.

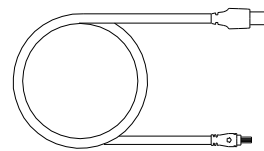

6 pin to 4 pin FireWire cable.

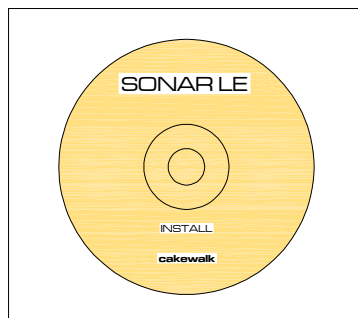

SONAR LE
Music Software Install disk.

SAFETY INSTRUCTIONS

WARNINGS - Read the following before proceeding :



ATTENTION: RISQUE DE CHOC ELECTRIQUE – NE PAS OUVRIR

- Read instructions:** Retain these safety and operating instructions for future reference. Adhere to all warnings printed here and on the console. Follow the operating instructions printed in this User Guide.
- Do not remove cover:** Operate the console with its covers correctly fitted.
- Power sources:** Connect the console to a mains power unit only of the type described in this User Guide and marked on the rear panel. Use the power cord with sealed mains plug appropriate for your local mains supply as provided with the console. If the provided plug does not fit into your outlet consult your service agent for assistance.
- Power cord routing:** Route the power cord so that it is not likely to be walked on, stretched or pinched by items placed upon or against it.
- Grounding:** Do not defeat the grounding and polarisation means of the power cord plug. Do not remove or tamper with the ground connection in the power cord.



WARNING: This equipment must be earthed.

- Water and moisture:** To reduce the risk of fire or electric shock do not expose the console to rain or moisture or use it in damp or wet conditions. Do not place containers of liquids on it which might spill into any openings.
- Ventilation:** Do not obstruct the ventilation slots or position the console where the air flow required for ventilation is impeded. If the console is to be operated in a rack unit or flightcase ensure that it is constructed to allow adequate ventilation.
- Heat and vibration:** Do not locate the console in a place subject to excessive heat or direct sunlight as this could be a fire hazard. Locate the console away from any equipment which produces heat or causes excessive vibration.
- Servicing:** Switch off the equipment and unplug the power cord immediately if it is exposed to moisture, spilled liquid, objects fallen into the openings, the power cord or plug become damaged, during lightening storms, or if smoke, odour or noise is noticed. Refer servicing to qualified technical personnel only.
- Installation:** Install the console in accordance with the instructions printed in this User Guide. Do not connect the output of power amplifiers directly to the console. Use audio connectors and plugs only for their intended purpose.

SAFETY INSTRUCTIONS

Important Mains plug wiring instructions

The console is supplied with a moulded mains plug fitted to the AC mains power lead. Follow the instructions below if the mains plug has to be replaced. The wires in the mains lead are coloured in accordance with the following code:



TERMINAL		WIRE COLOUR	
		European	USA/Canada
L	LIVE	BROWN	BLACK
N	NEUTRAL	BLUE	WHITE
E	EARTH GND	GREEN & YELLOW	GREEN

The wire which is coloured Green and Yellow must be connected to the terminal in the plug which is marked with the letter E or with the Earth symbol. This appliance must be earthed.

The wire which is coloured Blue must be connected to the terminal in the plug which is marked with the letter N.

The wire which is coloured Brown must be connected to the terminal in the plug which is marked with the letter L.

Ensure that these colour codes are followed carefully in the event of the plug being changed.

General Precautions:

Damage : To prevent damage to the controls and cosmetics avoid placing heavy objects on the control surface, scratching the surface with sharp objects, or rough handling and vibration.

Environment : Protect from excessive dirt, dust, heat and vibration when operating and storing. Avoid tobacco ash, smoke, drinks spillage, and exposure to rain and moisture. If the console becomes wet, switch off and remove mains power immediately. Allow to dry out thoroughly before using again.

Cleaning : Avoid the use of chemicals, abrasives or solvents. The control panel is best cleaned with a soft brush and dry lint-free cloth. The faders, switches and potentiometers are lubricated for life. The use of electrical lubricants on these parts is not recommended. The fader and potentiometer knobs may be removed for cleaning with a warm soapy solution. Rinse and allow to dry fully before refitting them.

Transporting : The console may be transported as a free-standing unit or mounted in a rack or flightcase. Protect the controls from damage during transit. Use adequate packing if you need to ship the unit.

Hearing : To avoid damage to your hearing do not operate any sound system at excessively high volume. This applies particularly to close-to-ear monitoring such as headphones and in-ear systems. Continued exposure to high volume sound can cause frequency selective or wide range hearing loss.



CONTENTS

Thank you for purchasing your Allen & Heath ZED-R16. To ensure that you get the maximum benefit from the unit please spare a few minutes familiarizing yourself with the controls and setup procedures outlined in this user guide. For further information please refer to the additional information available on our web site, or contact our technical support team.

<http://www.allen-heath.com>

<http://www.allen-heath.com/zed>

<http://www.myspace.com/thezedspace>

Warranty	3
Packed Items.....	4
Safety Instructions	5
Contents.....	7
Panel Drawings	8
Introduction to ZED-R16	9
Specifications.....	10
Dimensions.....	11
Block Diagram.....	12
Mono Input Channel	13
Stereo Input Channel.....	18
Studio Outputs & ST3 & 4 Inputs.....	20
Aux Masters and main Outputs.....	21
Master Section	22
Digital connections & switches.....	24
Digital I/O Configuration Specification	24
Digital I/O Configuration Diagrams.....	25
System Compatibility	26
Connecting to a Computer & Loading Drivers	27
ZED DICE Control Panel	29
Applications Drawings.....	33
Modes of Operation	35
SONAR LE Overview	42
SONAR LE installation	43
Configuring SONAR LE with ZED-R.....	43
Latency, Dropouts & buffer size.....	45
Enabling MIDI with SONAR LE	46
MIDI Implementation.....	47
Wiring diagrams for audio leads.....	49
Product Support	50

PANEL DRAWINGS ZED-R16

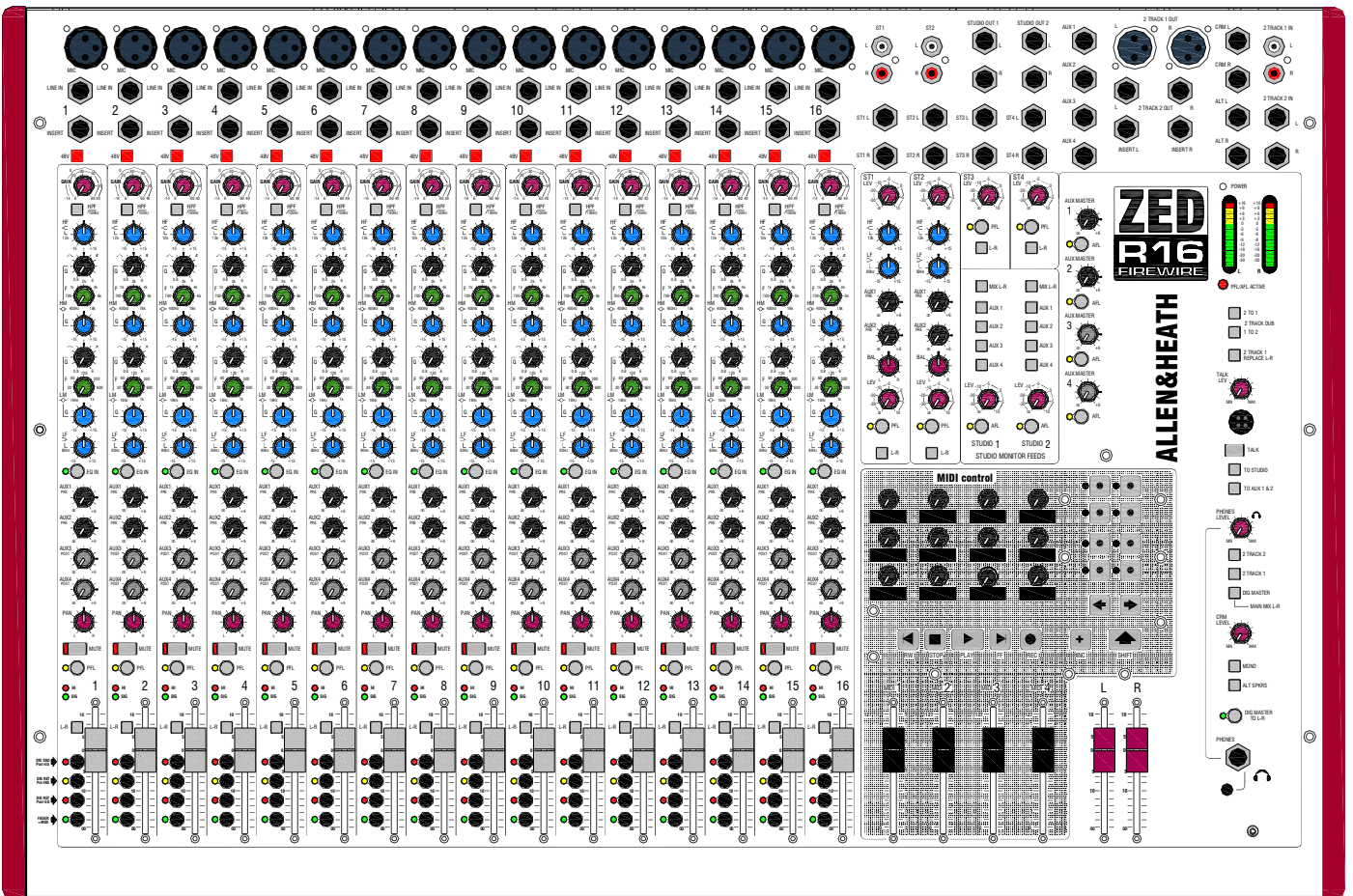
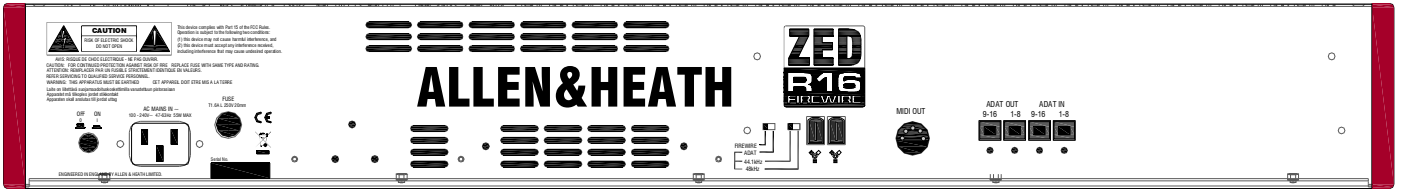

INTRODUCTION TO THE ZED-R16

A Technical Overview:

The Allen & Heath ZED-R16 mixer has been carefully and lovingly designed in the beautiful county of Cornwall in the UK and is manufactured alongside a wide range of professional audio mixing consoles.

Allen & Heath has a long history of making classic recording mixers such as the Sigma, Syncon, System 8, Saber and the GS3000, but for a few years have concentrated on the live sound, installation and pro DJ markets.

Re-entering the world of recording mixers is a very exciting prospect for us and our customers. We spent a long time examining how modern recording methods, equipment and software applications have changed the way musicians and sound engineers work, then over a pizza lunch at one PLASA show we cemented the ideas together as the original concept for ZED-R16.

ZED-R16 is designed to fulfil the needs of musicians and sound engineers with many requirements and different ways of working. With your ZED-R16 you can:

- Record multi-channel via FireWire or ADAT.
- Monitor each recording track via the FireWire inputs.
- Use the FireWire connections to and from each channel to insert processing plug-ins such as gates or compressors.
- Use the ZED-R16 to mix a live show and record it to multi-track (Either ADAT or FireWire).
- Mix in analogue using the FireWire inputs, pre or post EQ.
- Mix in digital using MIDI faders, rotaries and switches provided on the ZED-R16.
- Use analogue EQ as an analogue plug-in to a digital system.
- Use the professional studio features to control monitoring and artists feeds as well as transport control.

In many ways the ZED-R16 is a modern classic recording console. It has attributes of an old fashioned in-line recording mixer but with digital sends from each channel as the record path and digital returns being the monitor path. Add to this the flexibility of where you send or return the digital connections within the channel strip, and then the ability to use the faders and the other MIDI controllers to mix in your software application, it all adds up to a unique and mouth watering product.

The components used in ZED series are predominantly the same as in the larger Allen & Heath products and the construction methods are also very similar — utilising individual vertically mounted channel circuit boards with each rotary control fixed with a metal nut to the front panel. This provides a very robust product that will resist damage and give years of reliable use. It also makes servicing easier should it be required.

Mic/Line Pre-amps:

The ultimate performing pre-amps are fitted to ZED-R16. Similar only to those used in GL2800 & GL3800, they comprise a symmetrical circuit with individual linearising feedback to both phases, along with the lowest noise transistors available, providing astoundingly low distortion and noise which translates to superior clarity and dynamic range.

EQ:

Some may say that the ZED-R16 has too much EQ for this size of mixer with two fully parametric mid sections and yes it is powerful, but try it and you'll love it, especially the low mid-great for rich punchy bass guitar and powerful kick drum sounds.

MIDI Control:

There is a MIDI controller area in the master where 12 rotary, 4 linear and 12 switches can be mapped to control your software functions. In addition there are 5 dedicated transport keys, plus each of the 16 channel faders can be switched to MIDI control.

FireWire & ADAT:

Each of the 16 main channels plus the master left & right mix has a digital send and return. These are flexible in that the channel signals can be sent pre-insert or post EQ and the return can be switched into pre-insert or pre-fader or not switched in at all.

The FireWire controller we use in ZED-R16 is the DICE Jr from TC Applied Technologies and is capable of streaming up to 64 channels at a sample rate of up to 192kHz. The device employs a patented low jitter phase locked loop using its JET™PLL technology and is able to interface to the optical ADAT connectors giving a maximum of 16 ADAT inputs and outputs. Coupled to this are high quality 24 bit 114dB and 118dB ADC's and DAC's providing a super high quality link between the worlds of analogue and digital.

SONAR LE:

Included with your ZED-R16 is SONAR LE, a fully working light version (limited to 8 simultaneous inputs & outputs) of the award winning SONAR Producer audio workstation software from Cakewalk. Now you have SONAR LE, a discounted upgrade is possible once you've registered at cakewalk.com.

SPECIFICATIONS

Operating Levels	
Inputs	
Mono channel (XLR) Input	-6 to -60dBu for nominal (+14dBu in max)
Mono channel Line Input (Jack socket)	+14 to -40dBu (+34dBu maximum)
Insert point (TRS Jack socket)	0dBu nominal +21dBu maximum
Stereo Input (Jack sockets)	0dBu nominal (control = Off to +10dB)
Stereo input (phono sockets)	0dBu nominal (control = Off to +10dB)
2 Track Input (phono sockets)	0dBu nominal +21dBu maximum
Outputs	
Main (2 Track 1) L-R (XLR)	+4dBu nominal. +27dBu maximum.
L-R Insert (TRS Jack socket)	0dBu nominal +21dBu maximum
2 Track 2 Outputs (Jack sockets)	0dBu nominal. +21dBu maximum.
All other analogue outputs	0 nominal +21dBu maximum
Headroom	
Analogue Headroom from nominal (0Vu)	21dB
Digital converter headroom from nominal analogue (0Vu)	16dB
Frequency Response	
Mic in to Mix L/R Out, 30dB gain	+/-0.5dB 20Hz to 140kHz.
Line in to Mix L/R out 0dB gain	+/-0.5dB 20Hz to 20kHz
Stereo in to Mix L/R out	+/-0.5dB 20Hz to 40kHz
THD+n	
Mic in to Mix L/R Out, 6dB gain 1kHz +10dBu out	0.0025%
Mic in to Mix L/R Out, 30dB gain 1kHz	0.0045%
Line in to Mix L/R out 0dB gain +10dBu 1kHz	0.003%
Stereo in to Mix L/R out 0dB gain +10dBu 1kHz	0.004%
Digital Performance	
Analogue to Digital conversion	24bit 114dB dynamic range (A wtd)
Digital to Analogue conversion	24bit 118dB dynamic range (A wtd)
Sample Rate	44.1, 48, 88.2, 96kHz
Noise	
Mix Noise, LR out, 16 channels routed, Ref +4dBu, 22-22kHz	-88dB (-84dBu)
Mix Noise, Aux 1-4 out, sends minimum, masters at unity 22-22kHz	-86dBu
Mic Pre EIN @ 60dB gain 150R input Z 22-22kHz	-128.5dBu
MIDI	
Fader and Rotary values	0-127
MIDI switches	Note on/note off
Transport control	MIDI Machine Control
MIDI channel	Default = 16. User settable
Power consumption	48W

DIMENSIONS

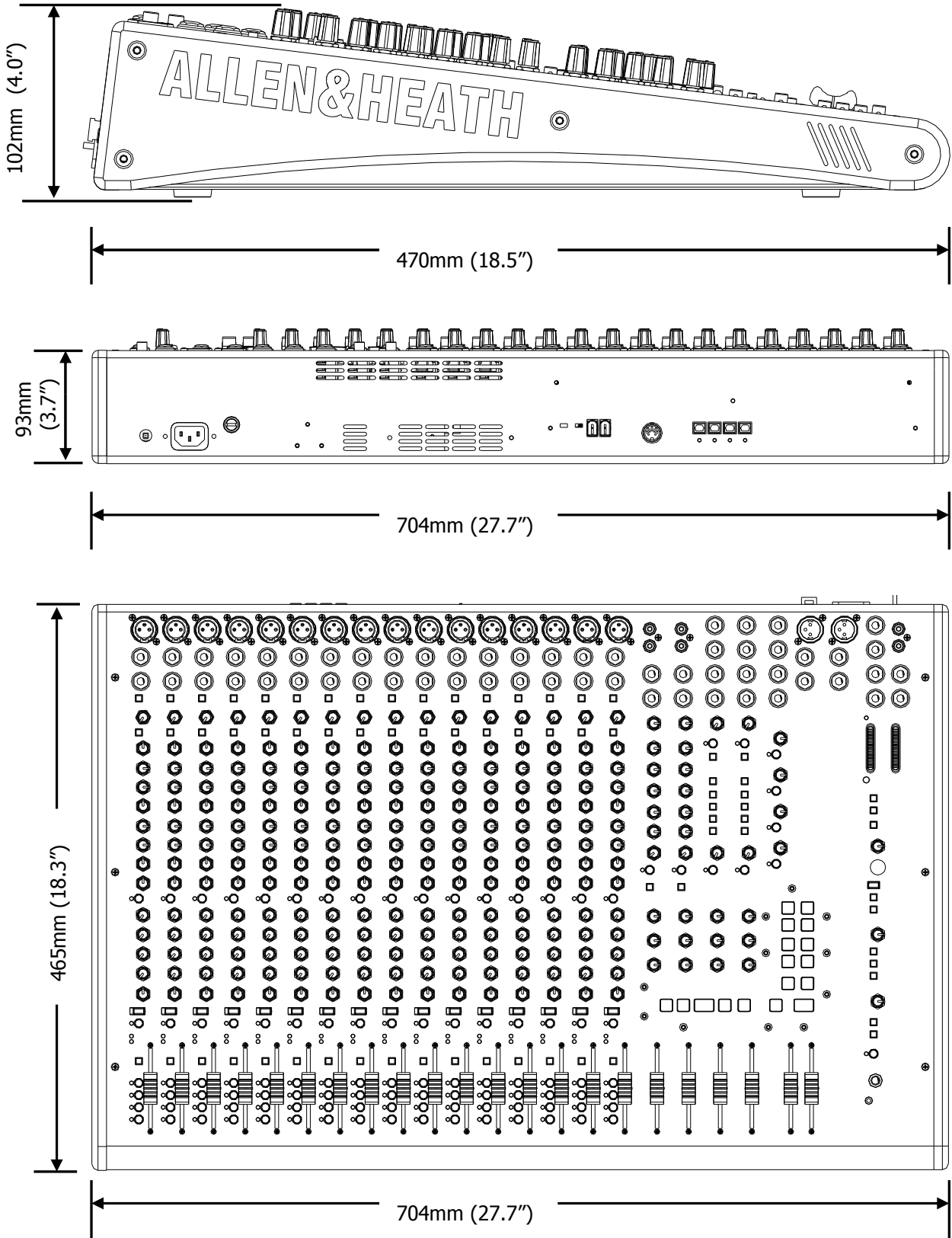

Weight kg (lb)		
	Unpacked	Packed
ZED-R16	13 (29lb)	15 (33 lb)

ZED-R 16 BLOCK DIAGRAM

BLOCK DIAGRAM

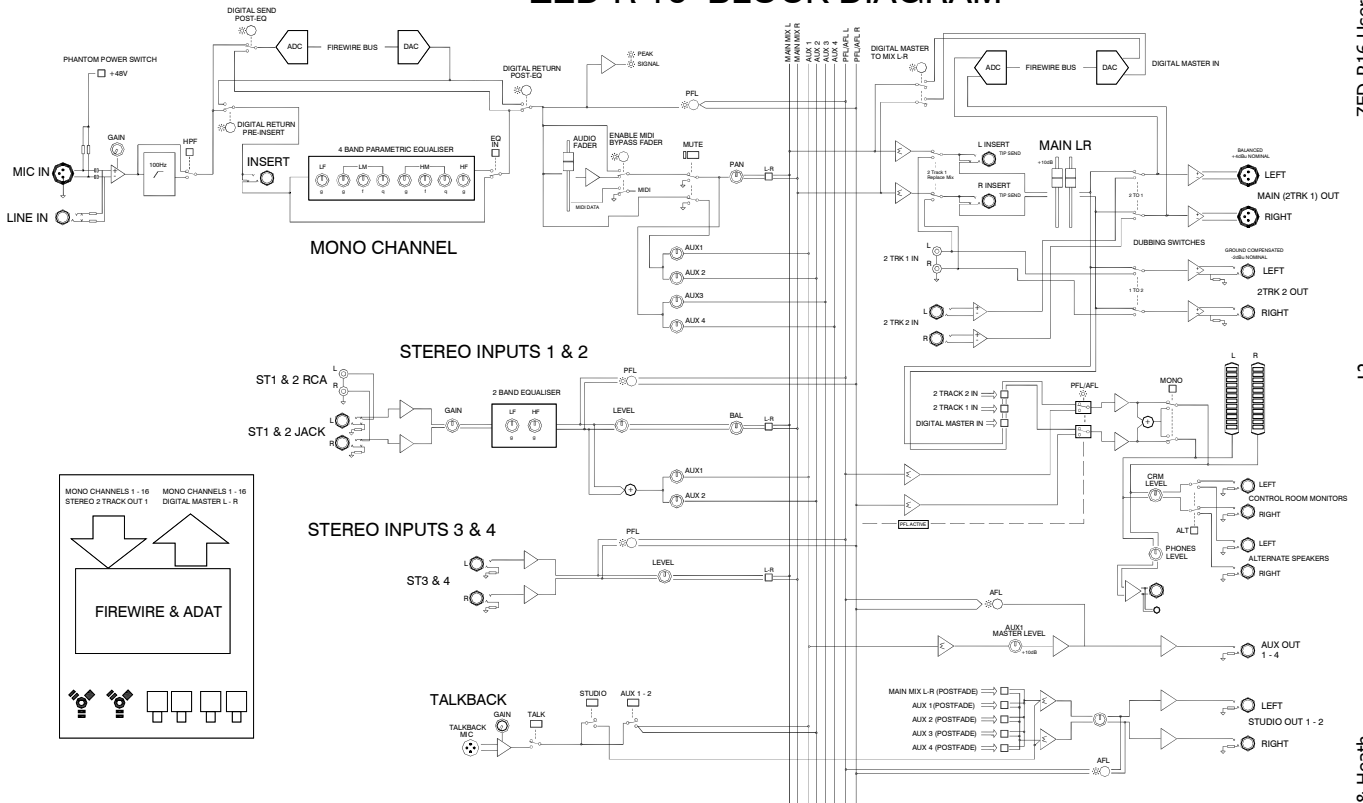

MONO INPUT CHANNEL

1

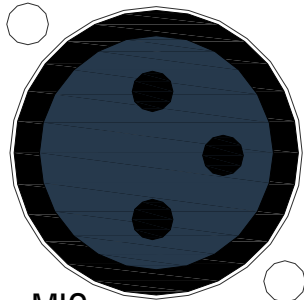

MIC

1

Microphone Input Socket

Standard 3-Pin XLR socket wired as Pin 1=Chassis, Pin 2=hot (+), Pin 3=Cold (-).

2

Line Input Jack Socket

Standard 1/4" (6.25mm) Jack socket for balanced or unbalanced line level signals. Wired Tip=Hot(+), Ring=cold (-), Sleeve=Chassis.

IMPORTANT NOTE:

The Line input signal is connected to the XLR input through attenuating resistors and coupling capacitors, in other words the two inputs are summed together at different levels. If Only the Mic input signal is required, make sure nothing is plugged into the Line jack and vice versa.

2

LINE IN

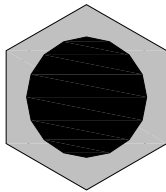

1

3

Insert Jack Socket

Standard 1/4" (6.25mm) Jack socket for unbalanced insert send and return signals. Wired Tip=send, Ring=return, Sleeve=Chassis. Nominal level is 0dBu. The insert point is after the 100Hz filter and before the EQ.

3

INSERT

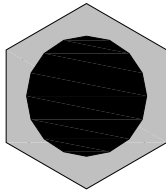

4

48V Phantom Power Switch

Applies +48V to pins 2 and 3 of the XLR input through 6k8 resistors for phantom powered condenser microphones.

4

48V



5

Gain Control

This adjusts the gain of the input amplifier to match the signal level of the input. The gain is varied from +6dB to +60dB for signals plugged in to the xlr socket (Mic Input) and -14dB to +40dB for signals plugged into the Line input jack.

5

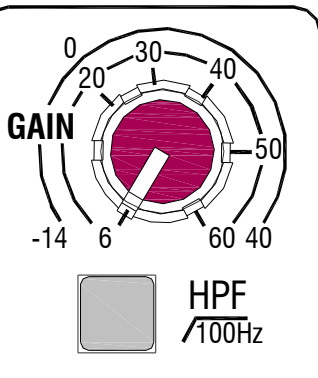

6

ZED-R 16 HI Pass Filter

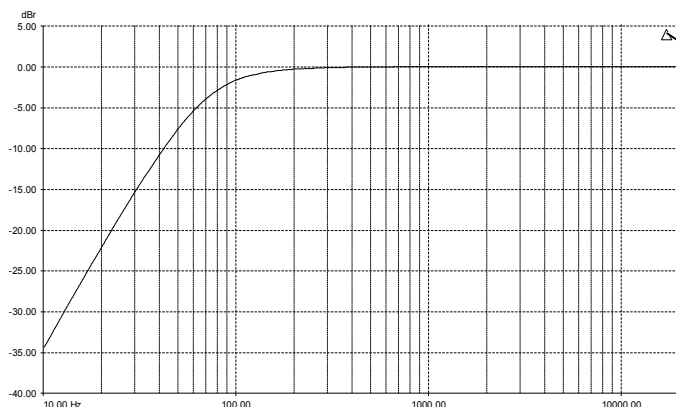

6

100Hz Hi-pass Filter

The Hi-pass filter is used for reducing pop noise and rumble from microphone signals. It is a 2-pole (12dB per octave) filter with a corner frequency set at 100Hz.

The filter affects signals from both Mic XLR and Line jack socket.

MONO INPUT CHANNEL

7

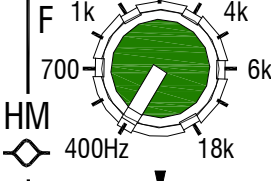
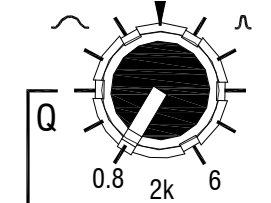
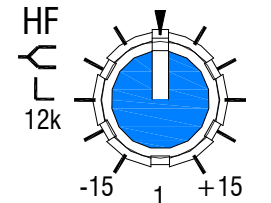

8

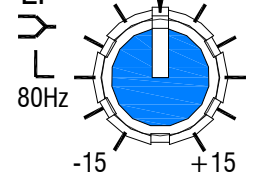
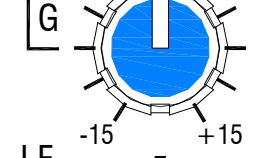
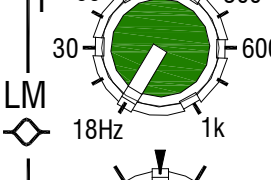
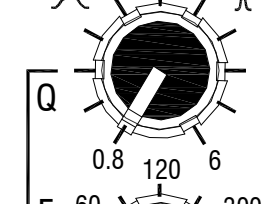
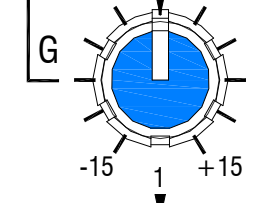

7

HF EQ

The HF (High Frequency) equaliser affects the frequency response of the higher audible frequencies. The corner frequency of 12kHz is around 3dB from the maximum cut or boost of the circuit.

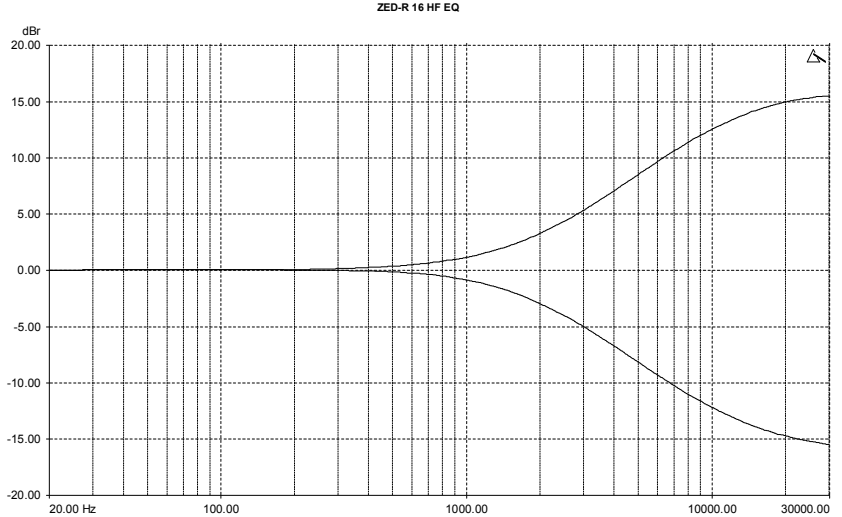

8

HMF EQ

The HMF (High Mid Frequency) equaliser affects the upper middle of the audible frequency range. The frequency graduations on the sweep control are the centre frequencies of the EQ. The Q factor is the width of the equaliser curve and is variable from a wide 0.8 to a sharp 6.

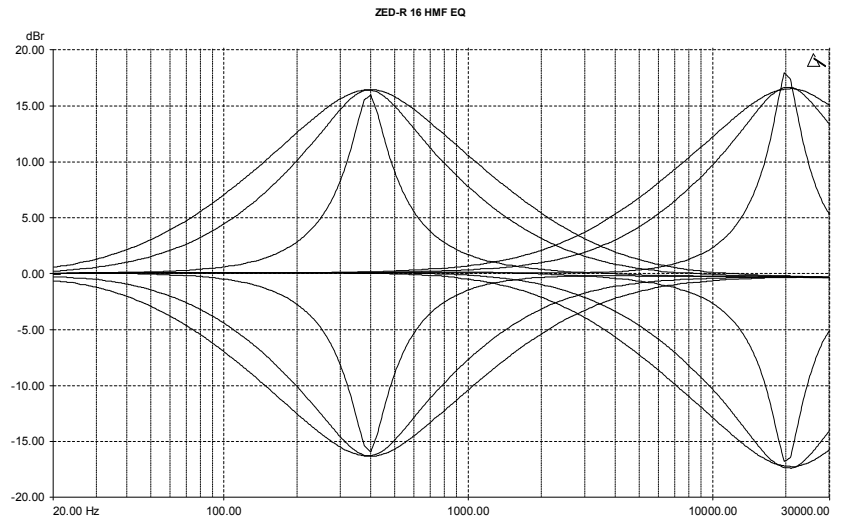

MONO INPUT CHANNEL

9

LMF EQ

The LMF (Low Mid Frequency) equaliser affects the lower middle of the audible frequency range. The frequency graduations on the sweep control are the centre frequencies of the EQ. As with the HMF section, the Q factor is variable from 0.8 to 6. The graph shows the Q setting in the minimum, middle and maximum positions, and the extents of the frequency range.

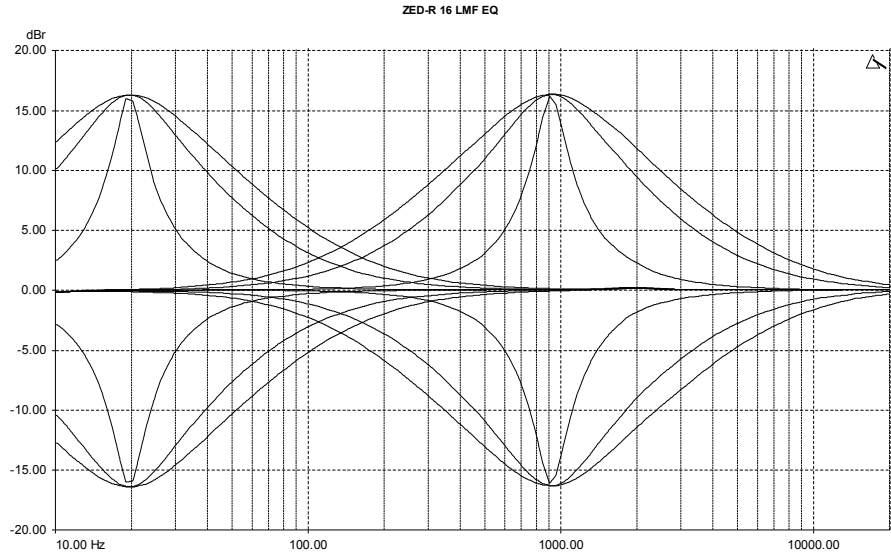

10

LF EQ

The LF (Low Frequency) equaliser affects the frequency response of the lower audible (bass) frequencies. The corner frequency of 60Hz is around 3dB from the maximum cut or boost of the circuit.

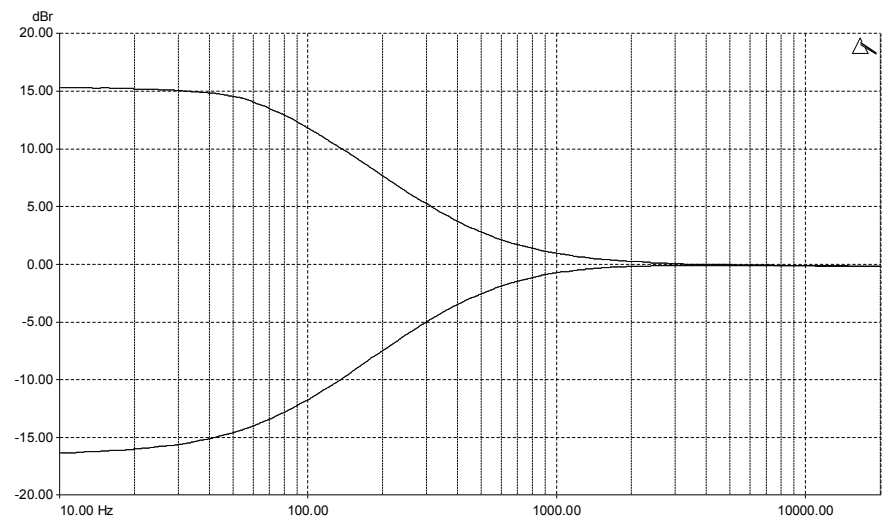

11

EQ IN

The EQ IN switch enables the equaliser when pushed in. The EQ is bypassed when the switch is in its up position.

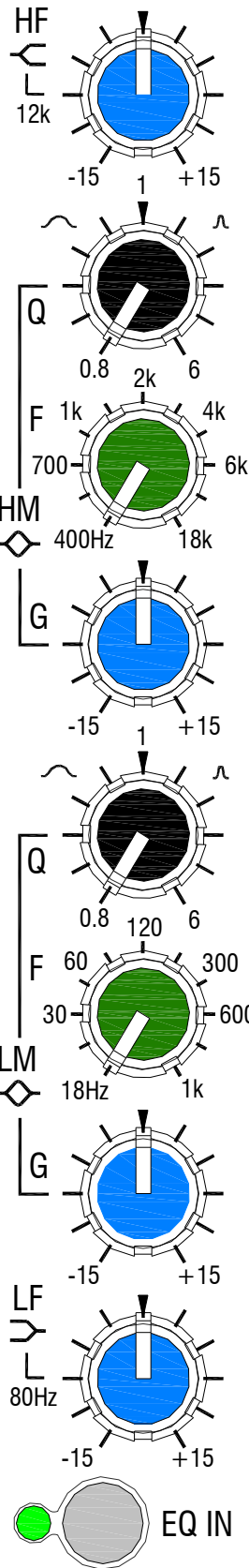

9

10

11

MONO INPUT CHANNEL

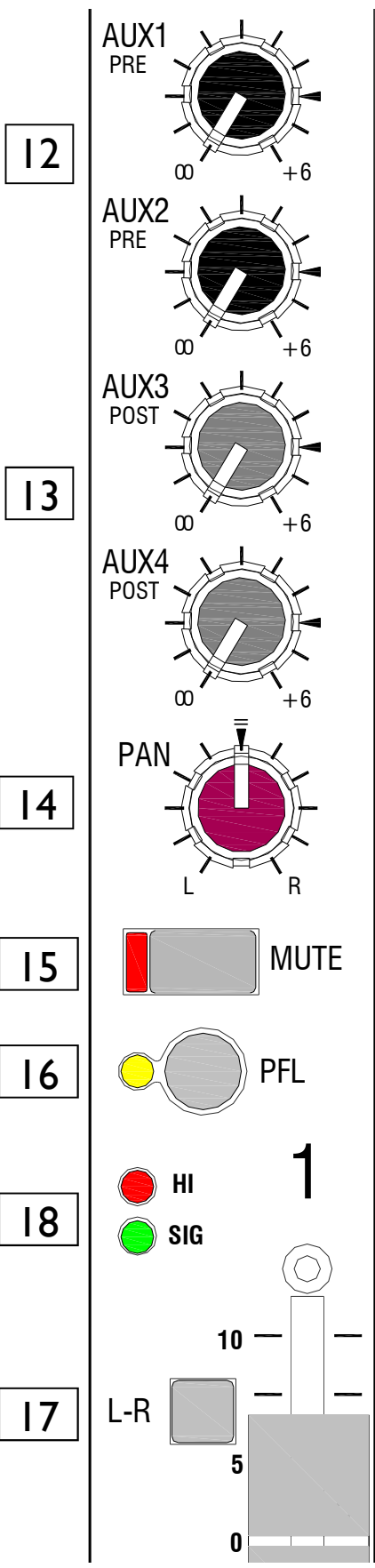

12 Auxes 1 & 2
 Each of these controls sends a signal to an auxiliary bus. The signal is sourced pre-fade which means that the level is independent of, and unaffected by the fader. Auxes 1 & 2 are primarily used for foldback monitoring purposes, as the fader does not affect the level. These sends are affected by the Mute switch, so muting the channel will also mute the Aux sends. The control varies the signal level to the bus from off (fully attenuated) to +6dB, with unity gain at the arrow. There are master level controls for all of the Aux outputs situated in the master section of the mixer.

13 Auxes 3 & 4
 The source for Aux sends 3 & 4 is post-fader. They are also muted by the Mute switch. Auxes 3 & 4 are primarily used for effects sends.
Jumper Link Options.
 There are optional positions for fitting link wires on the mono input channel circuit boards to change Auxes 1 & 2 to be post fade and Auxes 3 & 4 to be pre-fade sources. These are not easy to get to however, and involve taking out the channels from the mixer to access. We will try to improve this with future updates to the circuit board.

14 PAN
 The pan control adjusts how the signal from the mono input channel is shared between the left and right buses and subsequently the main stereo outputs.

15 Mute Switch
 This mutes or cuts the signal to the main L-R bus and the Auxes. A rectangular LED illuminates to show the Mute switch is pressed.

16 PFL Switch
 The PFL (Pre-Fade Listen) switch sends the channel signal to the PFL bus and subsequently to the headphones and the main left & right meters. Used for checking the audio signal before raising the fader or unmuting the channel.

17 L-R Routing Switch
 The L-R switch connects the post-fade signal to the main L-R mix bus via the pan control. For minimum noise from the mix bus summing amplifier, leave the switches in their up positions if the channel signal is not required on the bus.

18 Signal & High level indicators
 The Signal LED illuminates dimly at a threshold of -14dB nominal level and gets brighter with higher level signal. The source for the signal & peak LED's is just after the EQ IN switch.
 The HI signal LED illuminates when the signal just after the EQ IN switch is within 5dB of clipping.

MONO INPUT CHANNEL

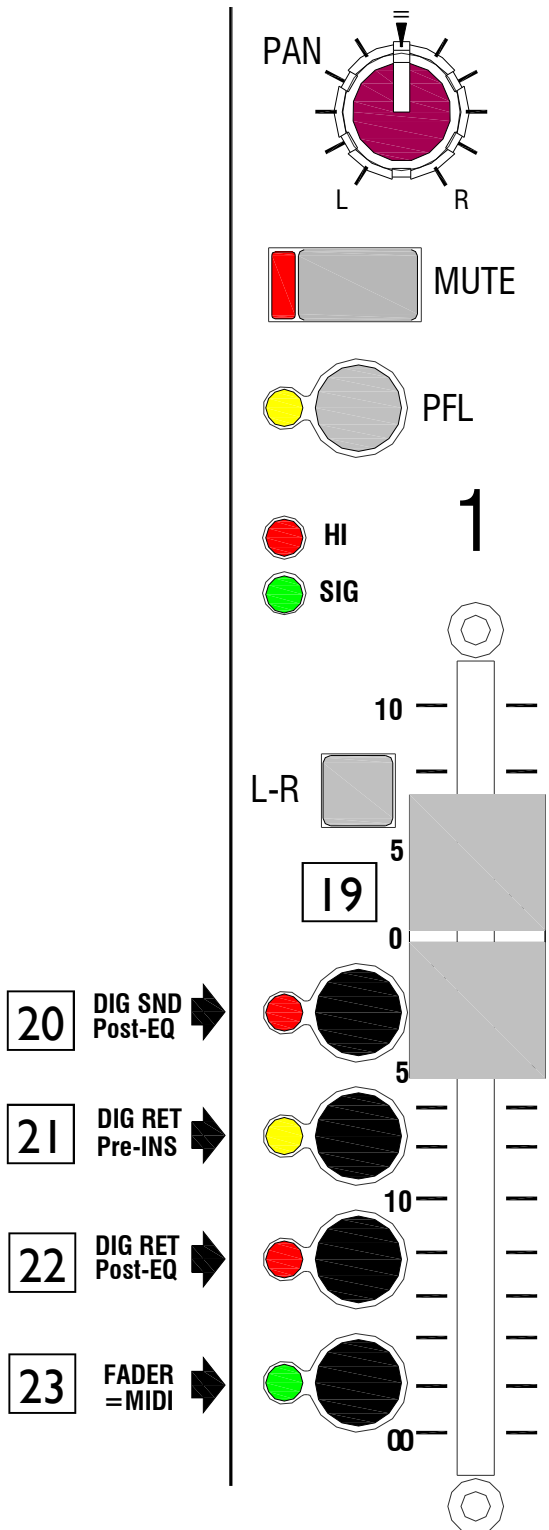

19 Fader
 The 60mm fader can be used as a normal channel fader where it will affect the level of signal to the main L-R bus and the post-fade auxes. There is 10dB of gain at the top of the travel. The fader can also be used as a MIDI controller if the FADER=MIDI switch is pressed on that channel. In this case, the audio is bypassed at unity gain and a continuous controller message is sent to the FireWire bus and the MIDI output DIN connector.

20 DIG SND Post EQ switch
 This switch determines the source for the digital output for each channel. In the up position the source is just after the pre-amp and Hi pass filter. If pressed in, then the source is from after the EQ IN switch. One or the other signal will always be sent for digital conversion.

21 DIG RET Pre INSert switch
 This switches the digital input for that channel into the channel path, replacing the signal from the pre-amp. The digital input is switched in just before the insert point. The switch below overrides this switch and the indicating LED is turned off if the switch below is pressed.

22 DIG RET Post EQ switch
 The digital input for that channel can also be switched in after the equaliser. This switch overrides the one above it as the digital input is switched in later in the signal path of the channel, and hence the LED extinguishes the one above it.

23 FADER=MIDI switch
 The 60mm fader can also be used as a MIDI controller if the FADER=MIDI switch is pressed on that channel. When pressed in, the audio is bypassed at unity gain and a continuous controller message is sent to the FireWire bus and the MIDI output DIN connector which can be assigned to control functions in your software application, or to control external MIDI equipment.

These configuration switches determine the mode of operation for ZED-R16 and are usually not required to be changed while the desk is in use. For this reason they are placed near the fader, and once set should not get in the way of normal operation.

STEREO INPUT CHANNEL

ST1

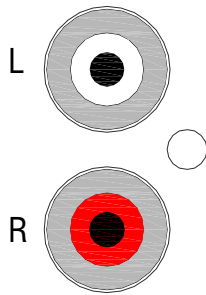

1 ST1 (& ST2) Phono & Jack sockets

Standard RCA phono sockets and 1/4" jack sockets for unbalanced stereo inputs. The RCA phono sockets normally connect through the jack break contacts so giving a choice of which connector type to use. The left signal does not connect to the right if nothing is plugged into the right socket though, as with some of our other products. If inputs are plugged into the jack sockets, the RCA phonos will be disconnected.

2 ST1 (& ST2) Level

The input level control varies the level of the signal from off (fully attenuated) to +10dB of gain at the maximum position.

3 STEREO Channel EQ

The EQ on the stereo Channel is 2 band shelving equaliser with fixed corner frequencies of 12kHz and 60 Hz.

1

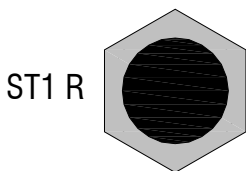
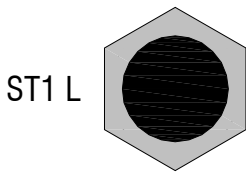

2

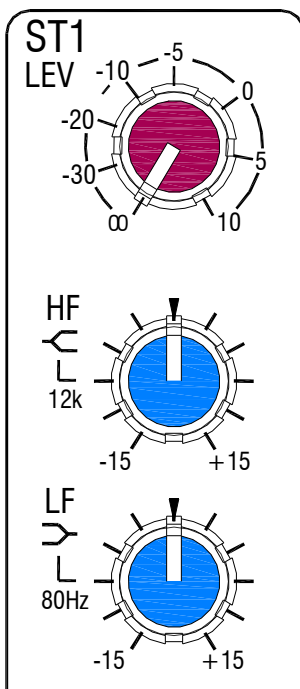

3

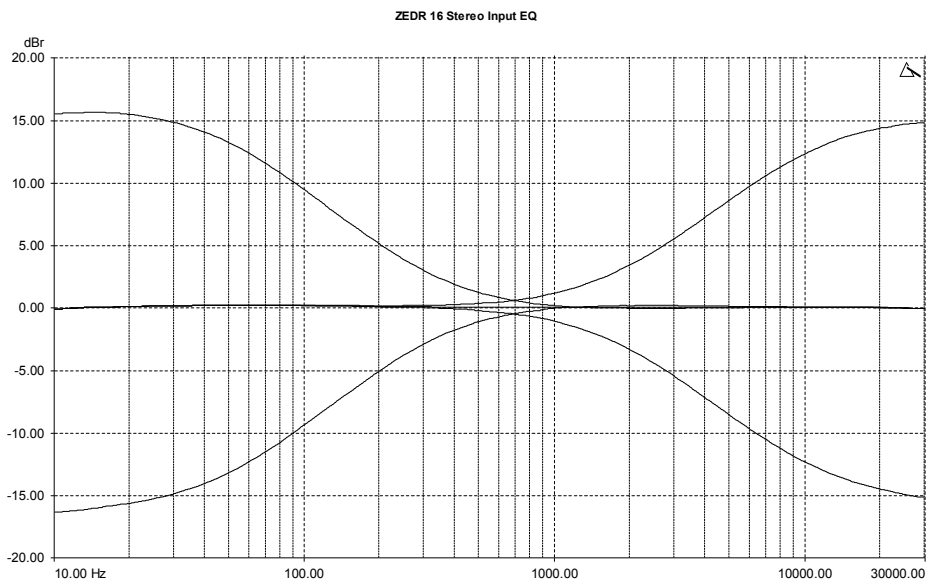

STEREO INPUT CHANNEL

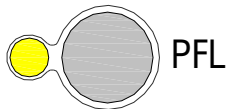
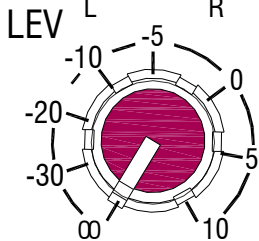
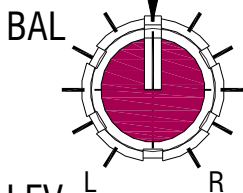
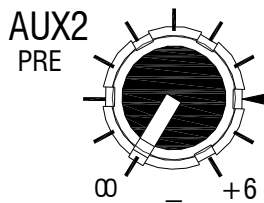
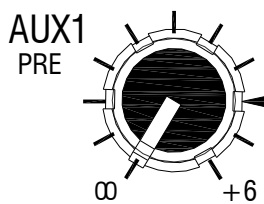
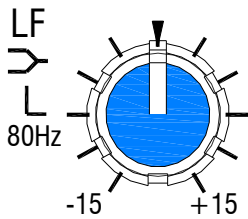
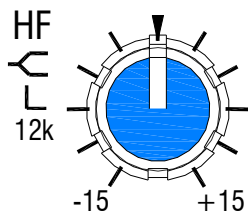

4

Auxiliaries 1 & 2

Each of these controls sends a mono signal to an auxiliary bus (a sum of the left & right inputs). The signal is sourced pre-fade which means that the level is independent of, and unaffected by the master level control. The control varies the signal level to the bus from off (fully attenuated) to +6dB, with unity gain at the arrow. There are master level controls for all of the Aux outputs situated in the master section of the mixer.

5

Stereo Balance control

The balance control adjusts the relative levels of the left and right signals to the main stereo bus.

6

Level control

Adjusts level of the left & right signals sent to the main L-R mix bus. There is 10dB of gain at the clockwise setting.

7

PFL

The pre-fade-listen switch sends the stereo signal to the PFL bus (in stereo) and activates the PFL monitor system in the master section. This allows the stereo channel signal to be checked before the master Level control.

8

L-R Routing Switch

Press this switch to send the stereo channel signals to the main L-R bus. For best performance, if the signals are not required or the channel is not in use, then leave the switch in its up position.

4

5

6

7

8

STUDIO OUTPUTS & ST3 & 4 INPUTS

STUDIO OUT 1



STUDIO OUT 2



ST3 L



ST4 L



ST3 R



ST4 R



9

ST3 & 4 Inputs

These stereo inputs have limited features and are provided for additional stereo sources that need to be added to the main L-R mix. The left input jack socket normalises or connects through the break contacts of the right input jack socket, enabling a mono input to be fed to both left and right mix paths.

10

Studio Monitor Outputs

The Studio Outputs allow a selection of signals to be sent as outputs for artists monitors.

The selection switches enable the main L-R mix (post fader) and auxes 1 to 4 (post master level) to the studio outputs. If more than one switch is pressed the signals mix together.

11

Studio Monitor Level control

The level control adjusts the output level of the Studio Outputs from off (fully attenuated) to +10dB maximum.

12

Studio Monitor AFL

The After Fade Listen switch sends the post level control Studio Output signals to the PFL/AFL monitoring system allowing them to be checked in the engineers headphones and control room monitor speakers.

9

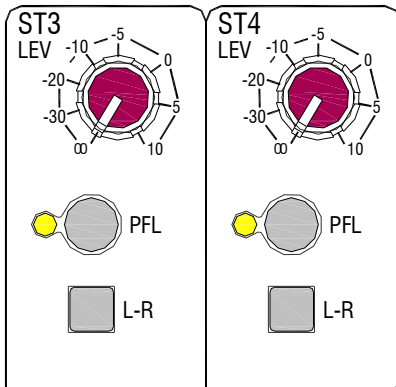

10

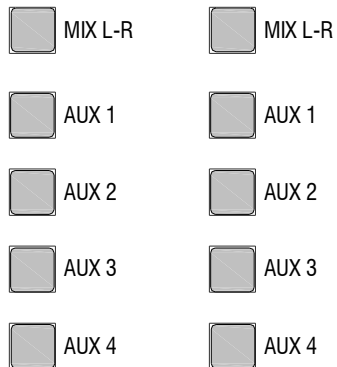

11

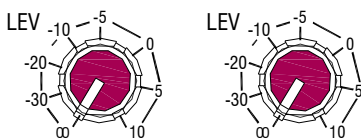

12

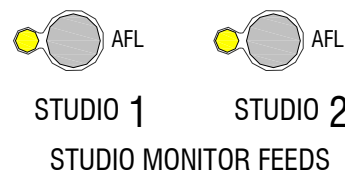

AUX MASTERS & MAIN OUTPUTS.

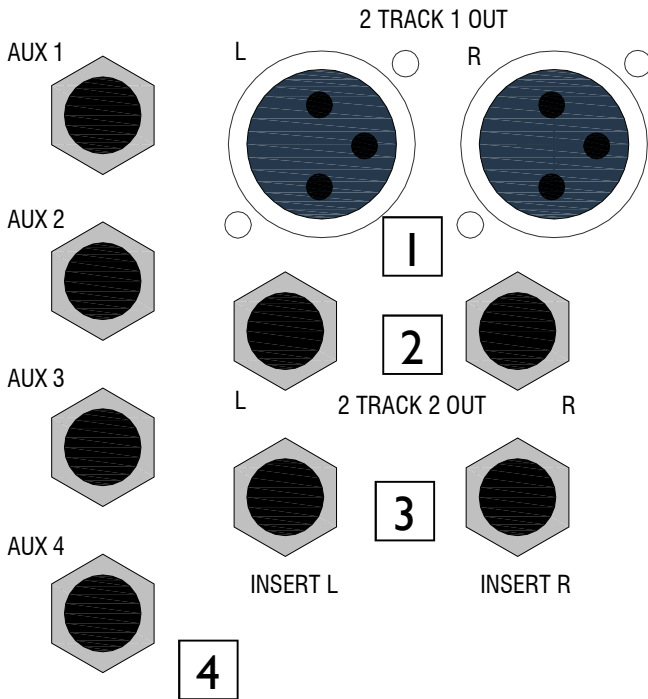

1 2 Track 1 Output XLR connectors
 Standard 3-Pin XLR panel plug wired as Pin 1=Chassis, Pin 2=hot (+), Pin 3=Cold (-).
 Electronically balanced, +4dBu = 0VU.
 These are the main stereo outputs, normally fed from the main L-R mix, they can be fed from the 2 Track 1 phono inputs if the Replace Mix switch is pressed (for background music or monitoring), also from 2 Track 2 jack inputs for dubbing or monitoring.

2 2 Track 2 Output jack sockets
 Standard 1/4" (6.25mm) Jack sockets.
 Ground compensated (noise balanced).
 Wired Tip=Hot(+), Ring=cold (-), Sleeve=Chassis.
 The 2 Track 2 outputs are normally fed from the main L-R mix, but can be sourced from the 2 Track 1 phono inputs for dubbing purposes.

3 Insert L & R jack sockets
 Standard 1/4" (6.25mm) Jack sockets.
 The main L-R mix insert connectors for inserting signal processing equipment such as compressors or equalizers. They are placed just before the main L-R faders in the signal path.
 Wired Tip=send, Ring=return, Sleeve=Chassis. Nominal level is 0dBu.

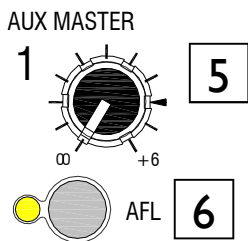

4 Auxiliary Output jack sockets.
 Standard 1/4" (6.25mm) Jack sockets for the Aux outputs 1—4.
 Impedance balanced. Wired Tip=Hot(+), Ring=cold (-), Sleeve=Chassis.

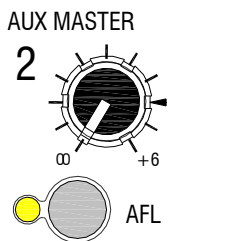

5 Auxiliary Output Master Level controls
 The Aux master level controls adjust the overall level of each of the Aux mixes 1 to 4. The range of control is from off (fully attenuated) to +6dB.
 There is an AFL (after fade listen) switch on each Aux mix to check the signal after the master level control.

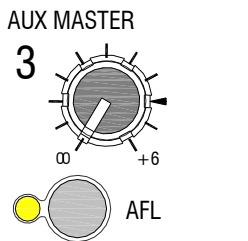

6 Auxiliary AFL
 The After Fade Listen switch sends the post master level control Aux signal to the PFL/AFL monitoring system allowing it to be checked in the engineers headphones and control room monitor speakers.

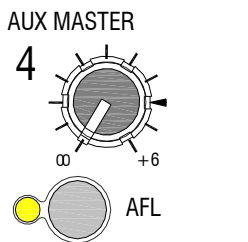

MASTER SECTION

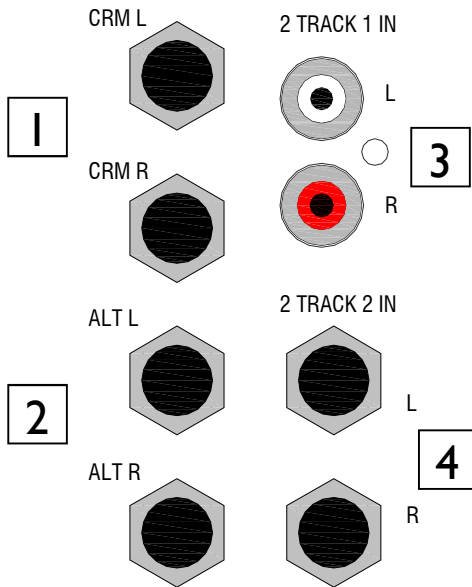

POWER

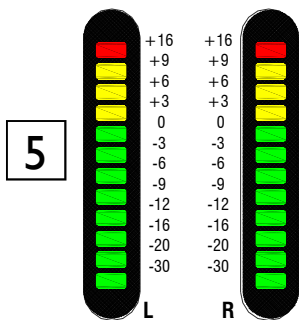

6 PFL/AFL ACTIVE

7 2 TO 1
2 TRACK DUB
1 TO 2

8 2 TRACK 1
REPLACE L-R

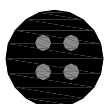
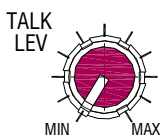

TALK

TO STUDIO

TO AUX 1 & 2

1 Control Room Monitor jack sockets
Standard 1/4" (6.25mm) Jack socket for connecting powered monitor speakers or an amplifier for the engineers control room monitor speakers. Impedance balanced. Wired Tip=Hot(+), Ring=cold (-), Sleeve=Chassis.

2 Alternate Monitor jack sockets
Standard 1/4" (6.25mm) Jack socket for connecting powered monitor speakers or an amplifier for an alternative set of speakers to the main CRM speakers. Typically these would be nearfield monitors or speakers in close proximity to the engineer. Impedance balanced. Wired Tip=Hot(+), Ring=cold (-), Sleeve=Chassis.

3 2 Track 1 Input phono sockets
Standard RCA phono sockets for unbalanced stereo sources. Useful for connecting equipment with stereo analogue outputs such as CD players and DAT machines for playing backing music, copying from one machine to another or simply listening to that machine.

4 2 Track 2 Input jack sockets
Standard 1/4" (6.25mm) Jack socket for connecting balanced or unbalanced stereo sources. The 2 Track 2 inputs are available to be switched to the 2 Track 1 (main xlr) outputs for dubbing or copying purposes.

5 Main meters
The main stereo 12 segment peak response slow decay meters are fed with the control room monitor signal (pre CRM Level). The selection switches for the CRM source are located below the Phones Level control and is over-ridden by the PFL or AFL signal if any listen switch is pressed.

6 PFL/AFL Active LED
Illuminates when any PFL or AFL switch is pressed. It indicates that the meters will show the PFL or AFL signal, or the mix of signals if more than one switch is pressed.

7 2 TRACK DUB switches
Allow dubbing or copying from one stereo source to another. If 2 to 1 is pressed then 2 Track 2 input jack sockets will be routed to the 2 Track 1 output xlr's. If 1 to 2 is pressed then 2 Track 1 input phono inputs will be routed to the 2 Track 2 output jacks.

8 2 TRACK 1 replace L-R switch
If this switch is pressed the main L-R mix is replaced by the 2 Track 1 input. The switch is situated before the insert points in the signal path, so any inserted processing will still have effect, as will the main L-R faders.

MASTER SECTION

2 TRACK 1
REPLACE L-R

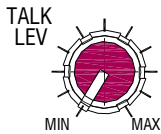

9

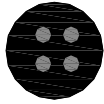

TALK

TO STUDIO

TO AUX 1 & 2

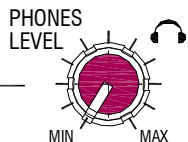

13

2 TRACK 2

10

2 TRACK 1

DIG MASTER

MAIN MIX L-R

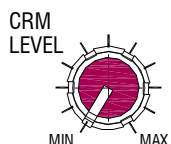

11

12

MONO

ALT SPKRS

DIG MASTER
TO L-R

15

PHONES

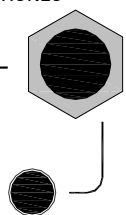

14

9 Talkback Section

A built in microphone and talkback system allows the engineer to talk to the artists in the studio or foldback monitors on stage. The Talk Level control adjusts the gain of the amplifier, be wary of feedback if the talkback signal is routed to the local monitors via the AFL system or the proximity of the studio monitors is such that they are able to feedback to the talkback microphone.

The To Studio and To Aux 1 & 2 switches route the talkback signal to the studio monitor outputs for artists monitor talkback or to the Auxes 1 & 2 for stage monitor talkback.

The non-latching TALK button enables the system and sends the signal from the microphone to the selected destination.

10 Control Room Monitor selection switches

These determine the source signal for the CRM system. With all the switches in the up position then the main L-R mix will be fed to the CRM speakers unless a PFL of AFL switch is pressed in which case the signal from the PFL or AFL switch will override.

The switches work on a priority method, with the 2 Track 2 switch having priority over the others.

The DIG MASTER switch monitors the digital 17 & 18 inputs a separate stereo digital input from the channel digital inputs and useful for monitoring a stereo mix from your digital audio workstation.

11 Control Room Monitor Level Control

Adjusts the level of the signal to the CRM speakers from off (fully attenuated) to unity gain.

12 MONO & ALT SPKRS switches

The MONO switch converts the stereo CRM signal to a mono signal, a sum of the left and right channels is fed to both left & right CRM outputs as well as the headphones output, and the main meters.

The Alternative speakers switch changes the CRM outputs from the main CRM jack sockets to the ALT jack sockets so that the outputs can be switched between two sets of speakers.

13 PHONES LEVEL control

Adjusts the level of signal from the CRM selection switches to the headphones jack sockets. There is 18dB of gain at the maximum setting.

14 PHONES jack sockets

Standard 1/4 inch and 3.5mm TRS jack sockets for stereo headphones. Tip = Left.

15 DIG MASTER TO L-R switch

In addition to the digital inputs to the 16 mono channels there is a further stereo digital input that can be routed to the main L-R mix bus with this switch. It can be used to monitor a stereo output from your digital audio workstation or audio application and listen to a final stereo mix from your computer.

DIGITAL CONNECTIONS & SWITCHES

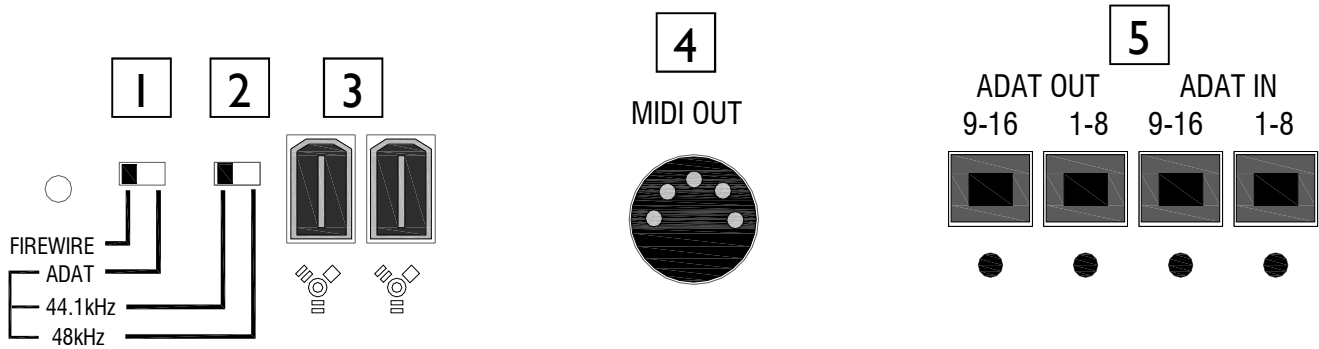

1 FireWire/ADAT configuration switch

This switch determines whether the digital interface is predominantly FireWire or ADAT and will be dependent on what type of external equipment is used. Set to FireWire if a computer or equipment with IEEE 1394 FireWire connection is to be used or ADAT if an ADAT machine only is to be connected. Select the switch to your desired setting **BEFORE** switching on power to the ZED-R16 because the switch is only read on power up.

2 ADAT sample rate switch

If ADAT is selected as the digital interface, the sample rate is set using this switch to either 44.1kHz or 48kHz. Again, select this switch to your desired setting **BEFORE** turning on power to the ZED-R16.

3 FireWire connectors

Standard 6 pin IEEE 1394 FireWire connectors for connecting ZED-R16 to a FireWire bus. Normally only one connector is used, however two are provided for connecting more than one ZED-R16 together for expanded capability. It is usually a more reliable method to connect to the FireWire bus once the ZED-R16 is powered on, rather than switching on the power with the FireWire bus already connected.

4 MIDI OUT DIN connector

A standard 5 pin DIN connector to output the MIDI data generated by the controllers on ZED-R to external equipment with MIDI functionality, for example when using ZED-R16 as a MIDI control surface. The MIDI data is also sent on the FireWire bus, so there is no need to use the DIN connector if MIDI is only required in the computer and the computer is connected to ZED-R16 using FireWire.

5 ADAT In & OUT connectors

Standard ADAT optical connectors for connecting external equipment with ADAT inputs and outputs.

DIGITAL I/O CONFIGURATION:

The number of digital channels and range of sample rate options are dependent on the configuration of ZED-R16. Here is a table of the options:

FireWire/ADAT Sw	Sample Rate (kHz)	FireWire Channels	ADAT Channels
FireWire	44.1 & 48	18 + 18	8 + 8
FireWire	88.2 & 96	16 + 16	None
ADAT	44.1	None	16 + 16
ADAT	48	None	16 + 16

DIGITAL INPUT & OUTPUT CONFIGURATIONS

DIGITAL I/O CONFIGURATIONS:

The following four set-up configuration diagrams show a schematic representation of the ZED-R16 digital I/O section connected to the recording/playback equipment. Note the FireWire channel differences at higher sample rate settings.

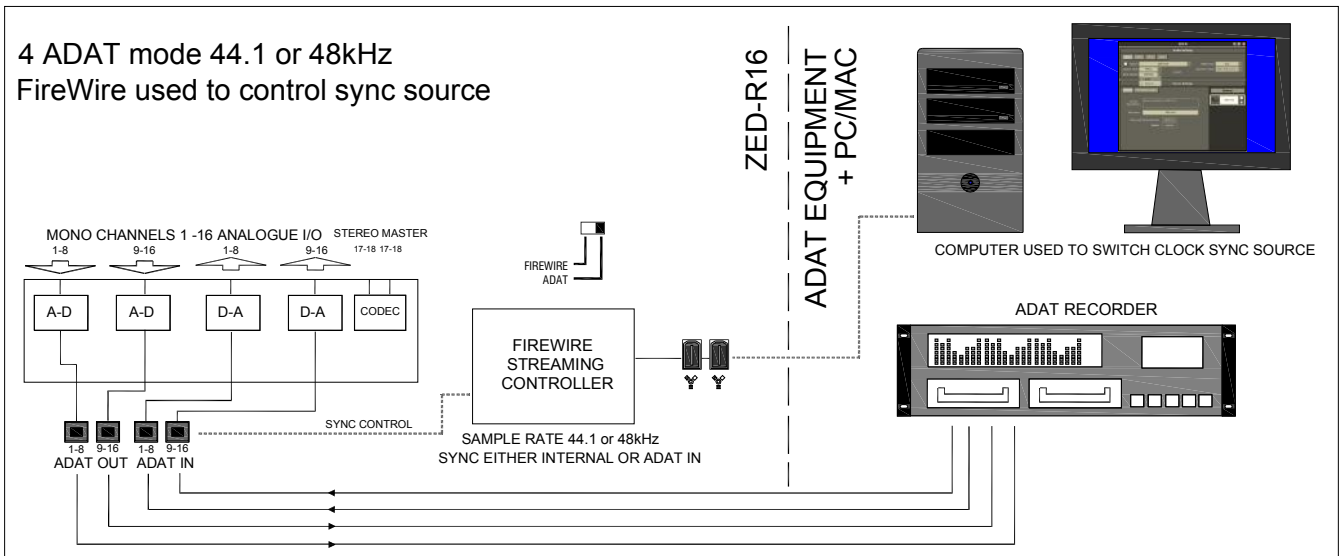
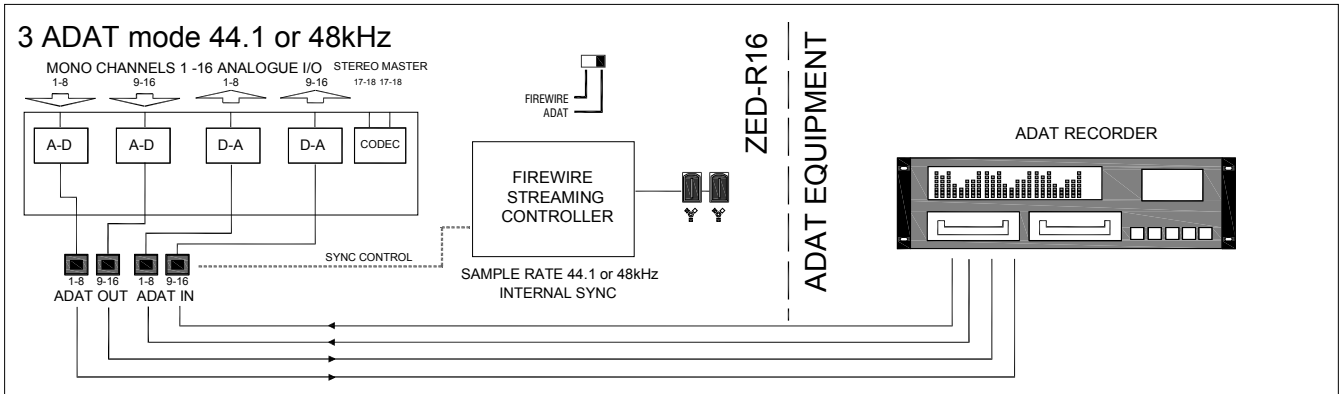
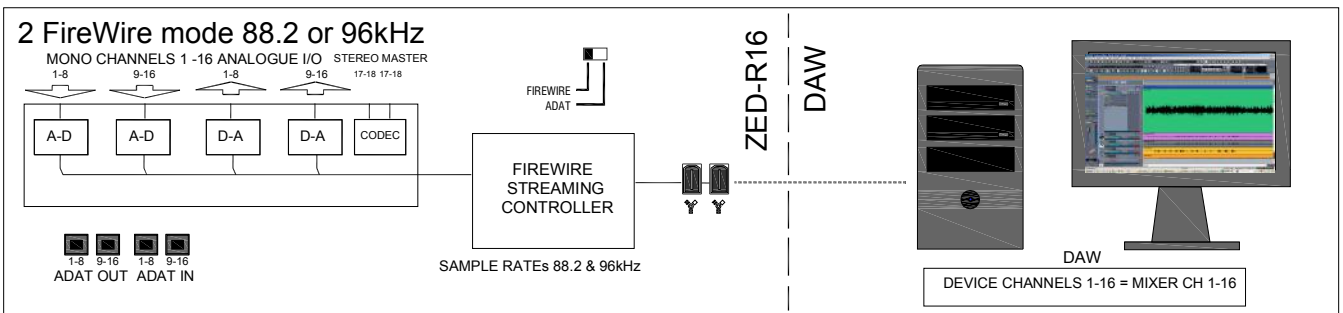
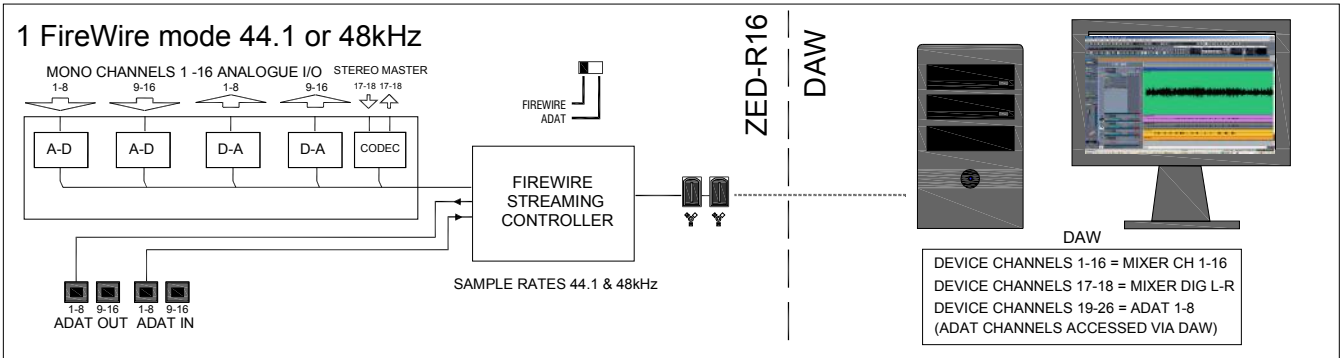

ZED DICE DRIVERS: SYSTEM COMPATIBILITY

DRIVER RELEASE VERSION: V3.3.2

The ZED DICE drivers are supplied to Allen & Heath by TC Applied Technologies Ltd. They are customised versions of drivers used in generic FireWire devices used extensively throughout the Pro Audio industry.

We at A&H endeavour to verify the stability and function of these drivers with different computers, operating systems and applications, however certain configurations of computer hardware and operating systems may not have been verified here at A&H.

Windows

Operating System	Status	A&H Verified
XP/32-bit	Delivered	Yes
XP/64-bit	Delivered	No
Vista/32-bit	Delivered	Yes
Vista/64-bit	Delivered	No

Mac (Intel & PPC Platforms)

Operating System	Status	A&H Verified
OSX 10.4.11 & up	Delivered	Yes
OSX 10.5.2 & up	Delivered	Yes

Computer System Specification Recommendations

It is difficult to specify minimum computer system requirements because we would be specifying the requirement for your computer and OS to connect to the ZED-R16 and transfer the audio data on the AS400 compliant FireWire bus which is only part of a digital audio recording, editing and playback system. Also, the fastest, most modern computer can have its audio streaming performance crippled by certain network drivers, system functions or power hungry applications, and especially the dreaded anti-virus software.

If we were to recommend a minimum general system it would be:

Operating System	CPU	Speed	RAM
XP	P4/equiv or higher	2.8GHz or higher	1GB or higher
Vista	Core 2 Duo or higher	2GHz or higher	2GB or higher
OSX 10.4.11/10.5.2+	Intel or PPC	2 GHz or higher	1GB or higher

Audio software & DAW compatibility

We are constantly updating the list of software applications that the ZED-R16 can be used with, so it's best to check the website for the up to date list. Also you should be able to find project templates already setup for ZED-R16, along with MIDI maps or mapping information for various DAWs and audio applications.

At the time of writing this guide, we have successfully tested ZED-R16 audio and MIDI communication with:

SONAR LE & Producer 7
Cubase Studio 4
Logic Express 8
ACID Pro 6

FL Studio
Audition 3
Ableton Live (MMC not tested)

CONNECTING TO A COMPUTER

Downloading the Drivers

Your ZED-R16 has software installed and working already, but in order for your Windows or MAC computer to be able to communicate with the FireWire device in ZED-R you'll need to load some Drivers onto your computer. The installer software is available on the Allen & Heath website at:

<http://www.allen-heath.com/zed/>

Microsoft Windows XP + Vista Installation:

Make sure that the ZED-R16 is **not** connected to your computer.

Save the installer program to your computer desktop.

Run the Installer program by double clicking it (**the ZED-R16 should still be disconnected**), following the prompts.

Run, Next, Next, Next, Next, Install, Continue Anyway, Finish.

Re-start your computer.

Switch on your ZED-R16 and connect the FireWire lead to your computer and your ZED-R.

Vista is now set up and ready to go. See Below.

Microsoft Windows XP installation:

You will be asked if Windows can connect to Windows Update to search for software—click No, not this time.....

Click Next

The Hardware Wizard will ask to install automatically or from a specific location—click automatically.....

Click Next

You may get a message or warning about Windows logo compatibility, click Continue Anyway.

Click Finish to complete the installation.

Microsoft Windows XP + Vista Installation:

The Drivers for ZED-R16 will now be installed and ready to use, a message may appear in the system tray to tell you.

The ZED-R Device control panel shortcut icon will appear on your desktop which enables the device settings like sample rate and buffer size to be adjusted.

The control panel will run only if ZED-R16 is connected to your computer via FireWire. If there is a connection problem you will get the message "Error in communicating with Driver"

In your programs list the control panel program will appear under Allen and Heath Ltd, and also an uninstaller should you need to remove the drivers at any stage.

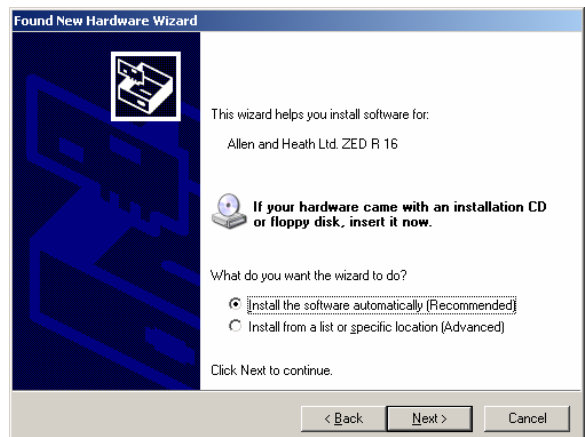

CONNECTING TO A MAC

Downloading the Drivers

Your ZED-R16 has firmware installed and working already, but in order for your MAC computer to be able to communicate with the FireWire device in ZED-R you'll need to load some Drivers onto your computer.

The installer software is available on the Allen & Heath website at:

<http://www.allen-heath.com/zed/>

MAC Installation:

Make sure that the ZED-R16 is **not** connected to your computer.

Save the **DMG** file to your MAC desktop.

Run the Installer program by double clicking it (the **ZED-R16** should still be disconnected).

Select the **PKG** application.

Click Continue.

Click Install.

Click Continue Installation.

Click Restart to complete the installation.

Switch on your ZED-R16 and connect the FireWire lead to your MAC and your ZED-R.

The Drivers for ZED-R16 will now be installed and ready to use.

The MAC is now set up and ready to go.

The ZED-R Device control panel icon will appear in your application which enables the device settings like sample rate and modes to be adjusted.

The control panel will run only if ZED-R16 is connected to your computer via FireWire. If there is a connection problem you will get the message "Error in communicating with Driver"

An uninstaller should you need to remove the drivers at any stage is included in the same **DMG** file as the install package.

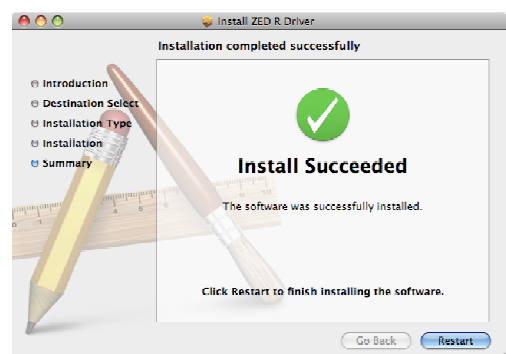
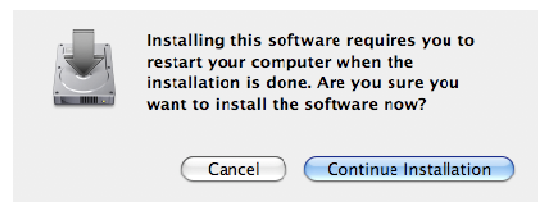
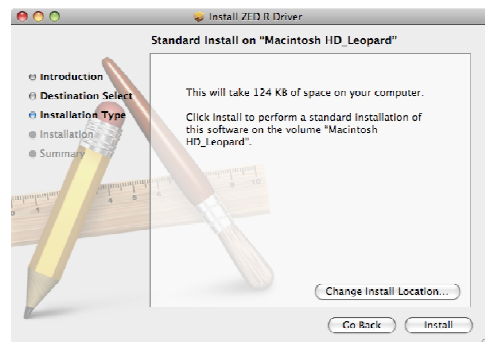
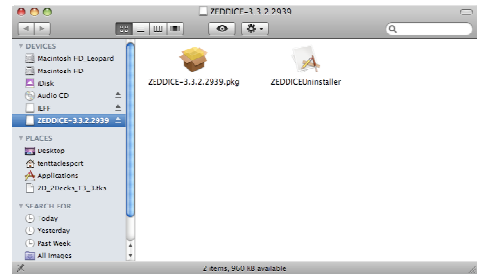

ZED DICE CONTROL PANEL

A description of the Control Panel for the ZED DICE driver v3.3.2.

Both the Windows & Mac versions are covered by this guide, the differences are highlighted where relevant.

The Windows or Mac installer program will install the driver software for the ZED DICE audio streaming device onto your computer, and a control panel application which can be used to check and set up certain parameters such as sample rate and synchronisation source.

The following is an overview of the control panel with an outline of its features and functions:

Screenshot of the Windows (XP & Vista) control panel.

The Mac version does not have the buffer size option box, the WDM tab or the DPC tab.

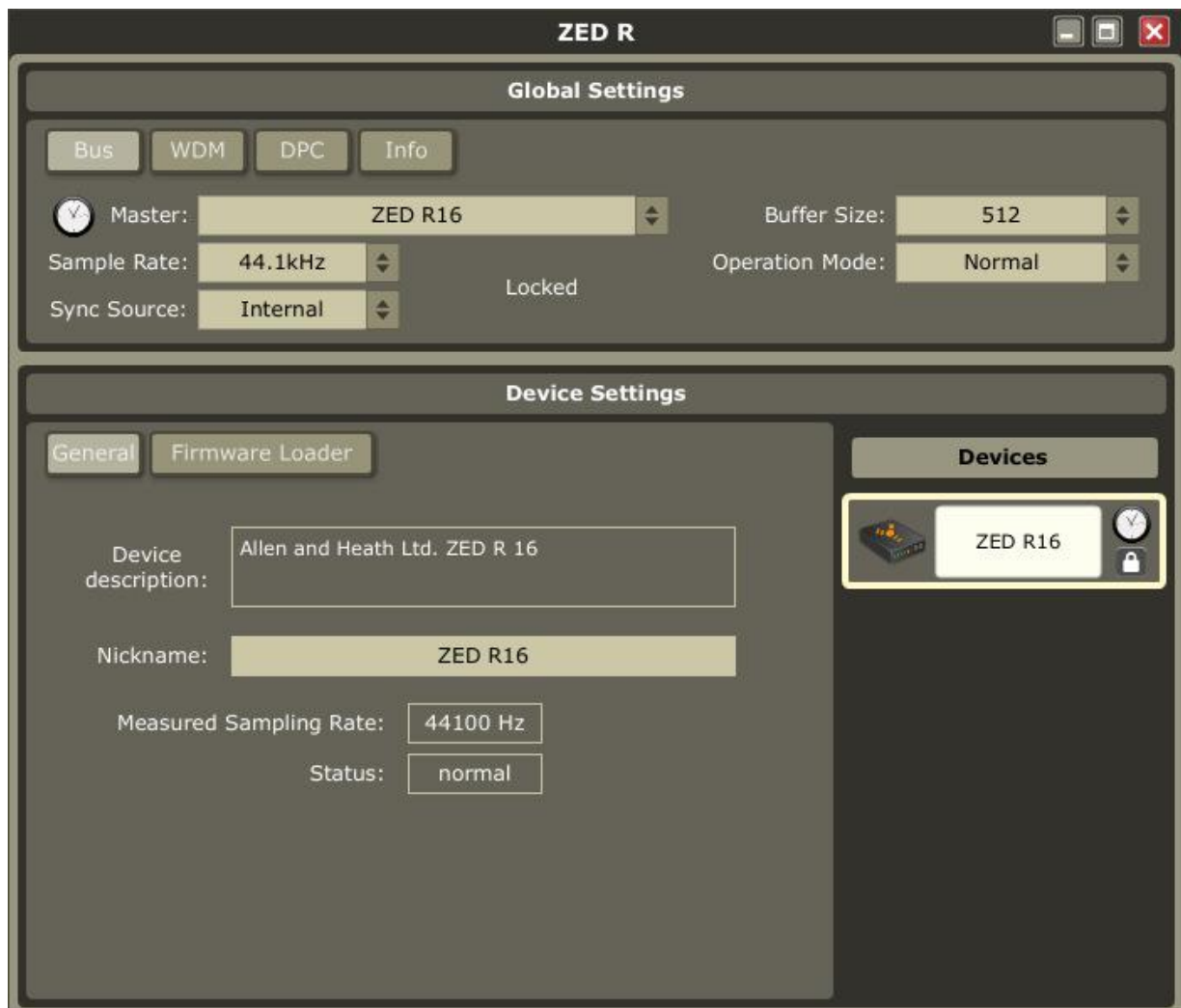

ZED DICE CONTROL PANEL

The control panel is divided into two main sections, Global Settings and Device Settings.

Global Settings

All system related settings are here, grouped into four Tabs for Windows, two for the Mac version.

Bus Tab:

Contains controls for choosing the system clock master device, sample rate, synchronisation source, buffer size, and operation mode.



When the mouse pointer hovers over the Master combo box, a ToolTip will display the IEEE1394 unique ID of the device.



The sample rate and sync source always refer to the selected clock master. When the device is not locked (synchronised and working at the selected sample rate), a warning icon will appear under the Master display box. Hovering the mouse pointer over the text will display a message stating whether the master device is locked or not.



The Buffer Size (Windows only) option box contains a number of predefined sizes in its drop-down menu, or you may type in a value. Depending on the setting, the driver may round the value and the current Operation Mode will enforce limits on the buffer size, so the resulting value may not always be the same as what is entered.

The Operation Mode enforces buffer levels which help prevent performance-related dropouts when using audio on computers. The higher the Mode number, the less chance of audio artefacts, with the sacrifice of increased system latency. Dropouts are caused by the configuration of the computer, and also by what other applications are running at the time, and lastly by the worst-case DPC latency caused by other drivers. Network drivers, for example, are a notorious source of latency on an otherwise high-performance computer.

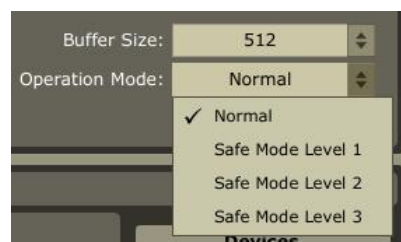
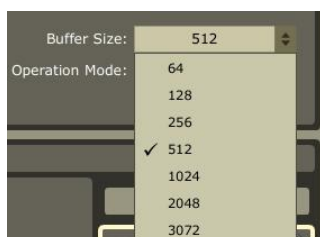

ZED DICE CONTROL PANEL



The WDM tab (Windows only) can be used for enabling or disabling the Windows Driver Model audio channels, configuring them as mono, stereo or surround, depending on your computer's capability, and mapping the WDM channels to the required channels on your ZED-R16. For example you can map the stereo WDM channels to the master L-R channels (17-18) on your mixer so that your computer CD player and general audio will be played to the Master L-R channels for monitoring.

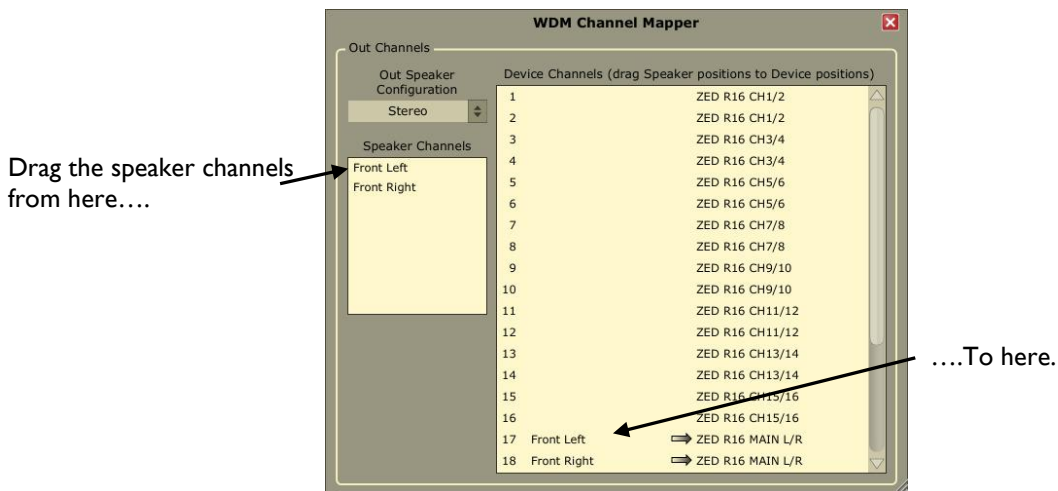

The DPC tab (Windows only) allows a utility to check your computer for excessive Deferred Procedure Call latencies. Basically it checks the capability of your computer to handle real time audio streams by looking at how quickly your computer can get around to processing the audio data streamed into the buffers and if there are any hold-ups caused by other drivers or processor interrupts. The result of a high DPC latency measurement (this is not the overall FireWire latency), would be clicks in the audio or dropouts in communication with the computer or audio application.

Once enabled, the checker will continue to measure if another tab is selected, or the control panel is minimised and the peak measurement is displayed in the box below the bargraph.

The measurement may be affected by other applications running on the computer, especially if they use a lot of processor power.

If high latency measurements are reported, the recommended operation mode may be one of the safe modes to prevent drop-outs, at the expense of FireWire bus latency timings.

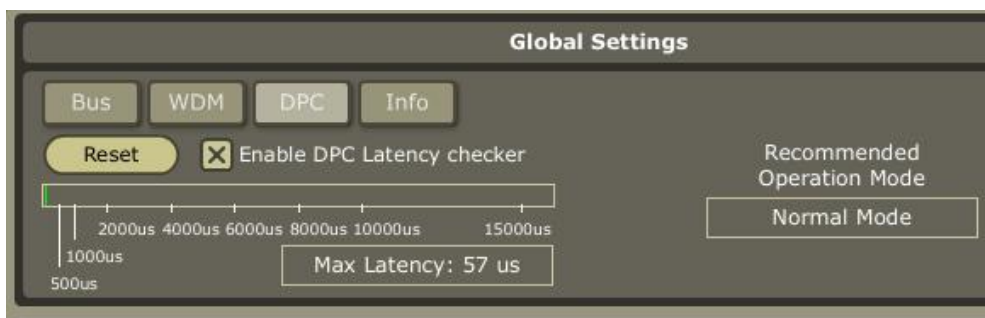

The Info tab displays the Driver version number of the driver and the PAL number of the version compiled for the application.

ZED DICE CONTROL PANEL

Device Settings

This area of the control panel shows information for the ZED-R16 if connected to the FireWire bus. The device (mixer) is shown in the Devices list on the right, the clock symbol is displayed if it is the clock master and a padlock symbol shows if the device is locked or unlocked (synchronised or not).



On the left of the Device Settings area are two Tabs, General and Firmware Loader.

The General tab displays the device description which should be set to Allen & Heath Ltd. ZED R 16 if connected, and the Nickname box allows the user to give a particular name to the mixer connected which is useful if different mixers are being used, or if two are connected together (this is possible but is not described in this control panel guide). Underneath the device Nickname, the actual measured sample rate is displayed along with the device status.

An alert icon will appear on the device list item to show that certain events have been logged which apply to the device shown such as the device being locked or unlocked temporarily. The icon will fade, but if the mouse is hovered over the icon before it fades the reported events will appear as a ToolTip. When the icon has faded, shift+clicking over the device box in the Devices list will show the most recent 40 events logged.



The Firmware Loader tab allows the user to upload new Firmware to the ZED-R16. The procedure for doing this is not described in this control panel guide.

Parameter Locking:

When an audio application is running on the computer, certain functions are locked by the control panel for example the sample rate setting. A ToolTip will appear to inform the user of this if the mouse pointer is hovered over the relevant parameter box.

To access these parameter settings, the audio application should be closed and re-opened after the settings are made.



APPLICATION DRAWING: STUDIO

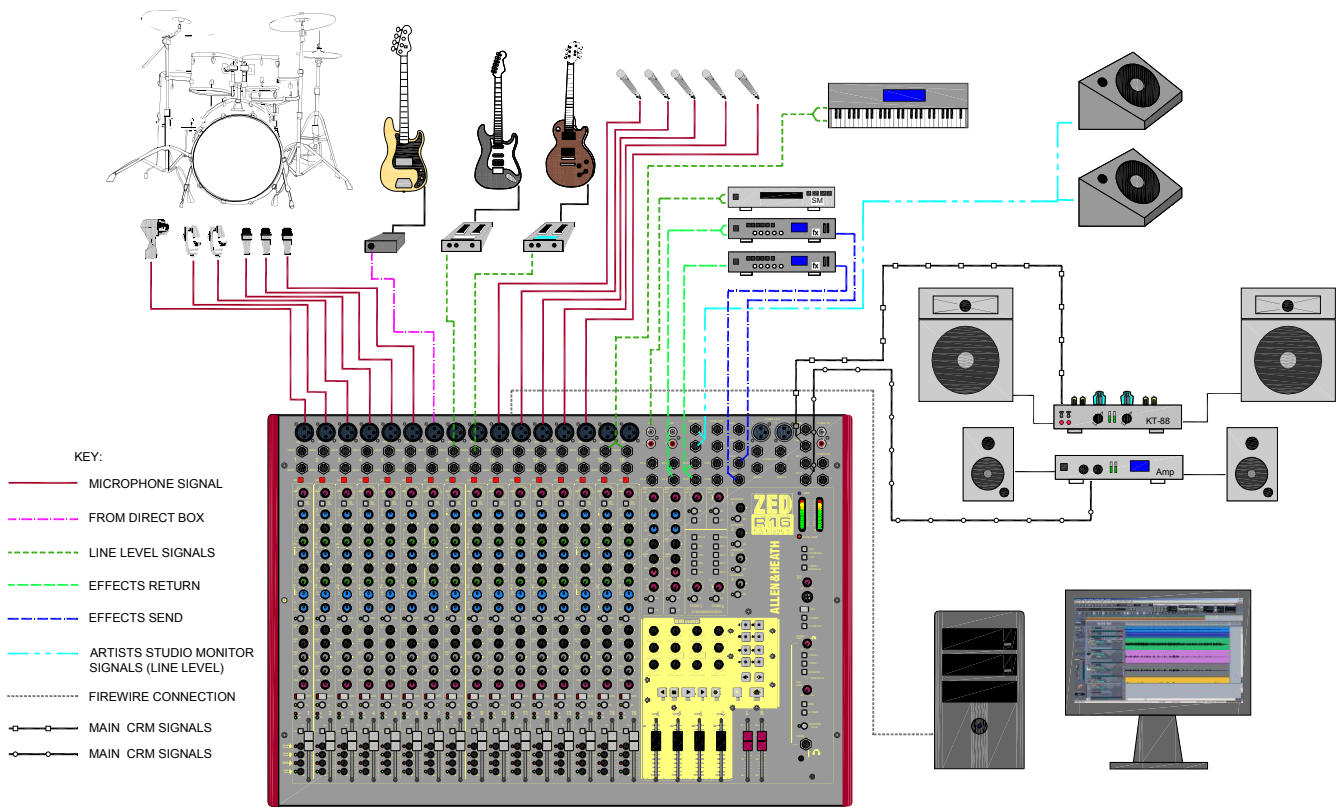

APPLICATION DRAWING: LIVE SOUND

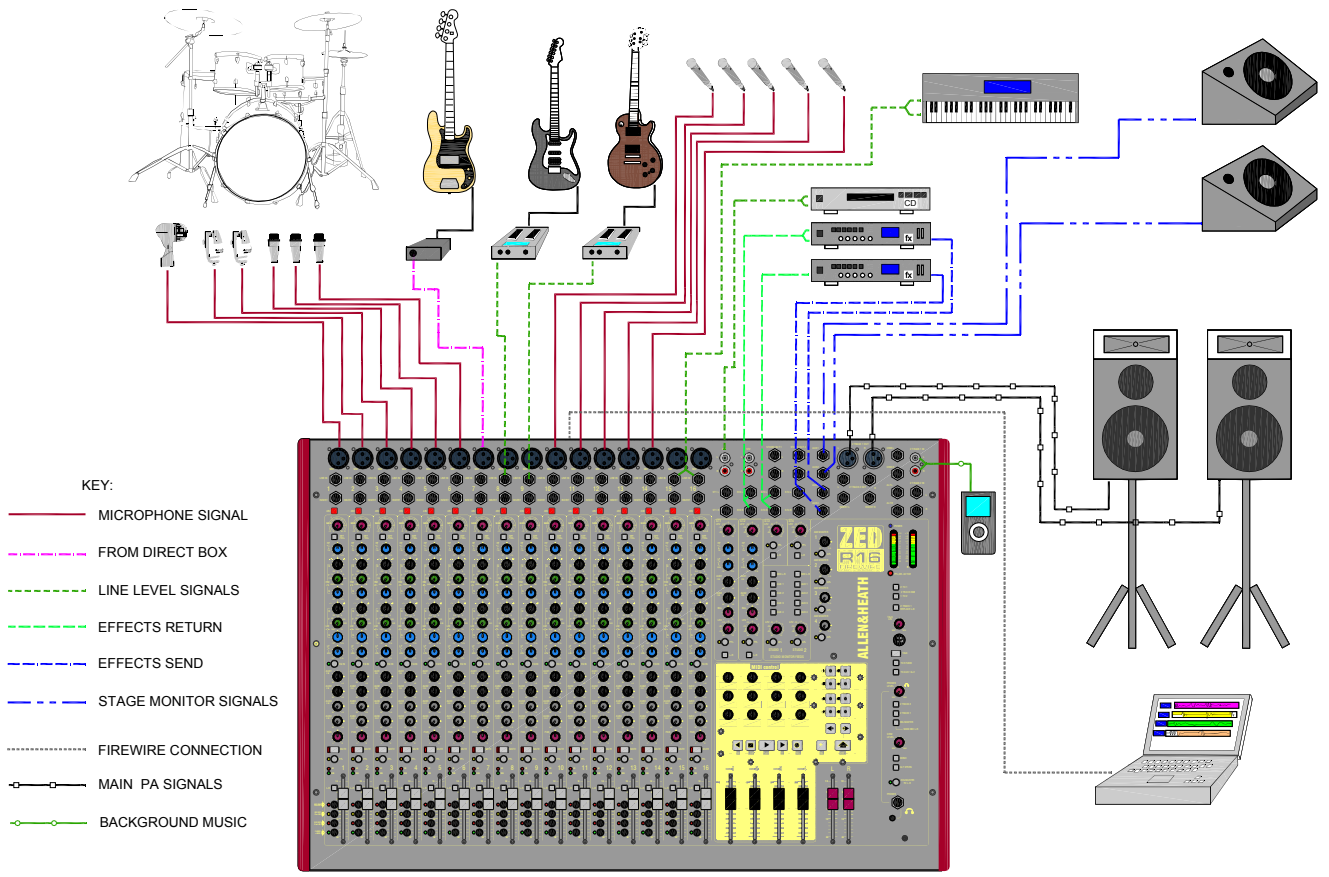

MODES OF OPERATION

RECORDING PRE-EQ FROM AN ANALOGUE MIX

The basic mode for ZED-R16 with all the configuration switches in the up position (not pressed). ZED-R16 can be operated as a traditional analogue mixer, using the main L-R mix as a stereo monitor mix for the multitrack recording, or as a PA mix if working live. A clean recording feed will be sent on the FireWire bus or the ADAT outputs for recording each channel, sourced from just after the pre-amp and hi-pass filter.

ANALOGUE SIGNAL

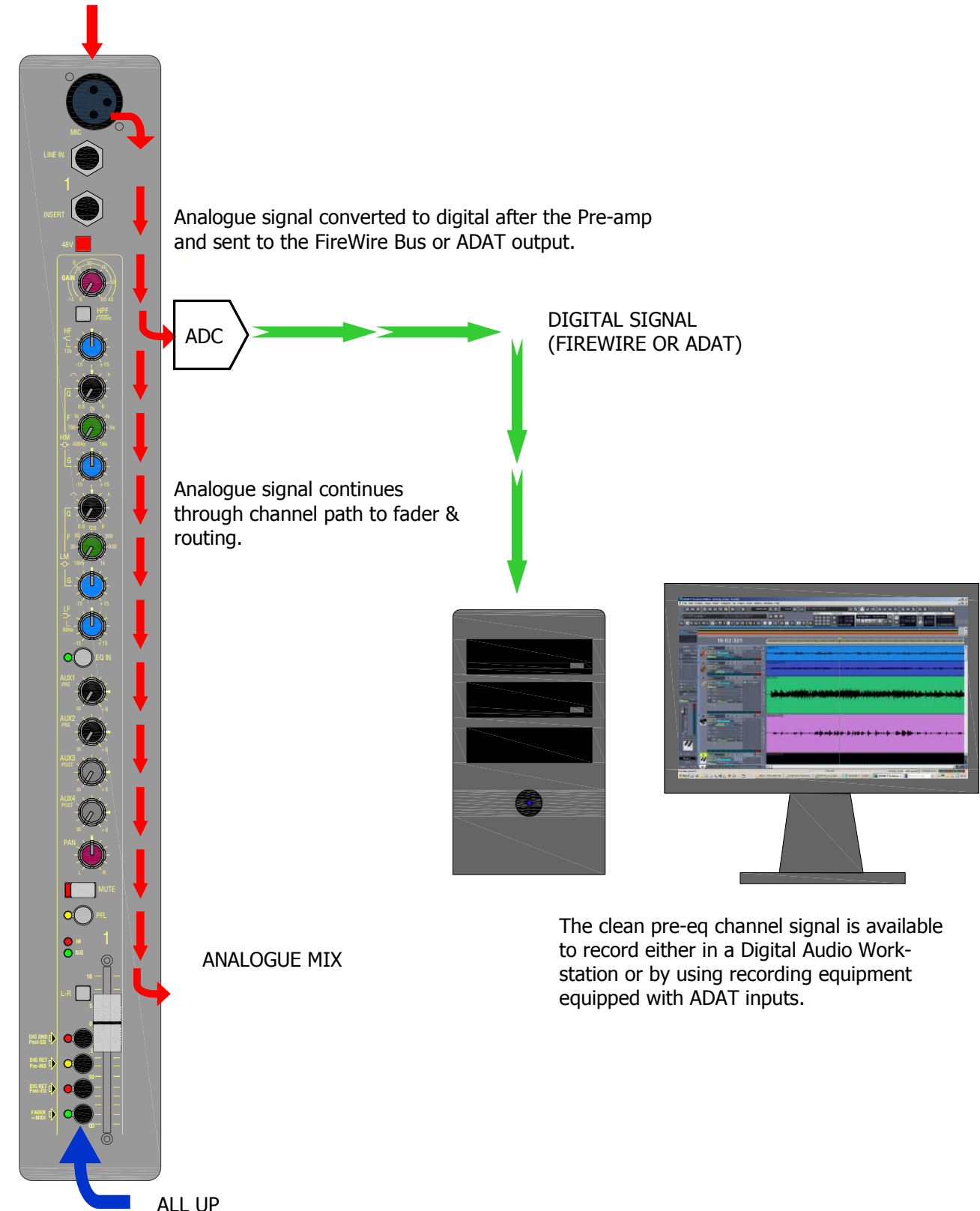

MODES OF OPERATION

RECORDING POST-EQ FROM AN ANALOGUE MIX

If the DIG SEND = POST EQ switch is pressed then the digital output from the channel will be sourced from after the equaliser. Use this mode if you want to use ZED-R16 as an analogue mixer and want to EQ the signal being recorded.

ANALOGUE SIGNAL

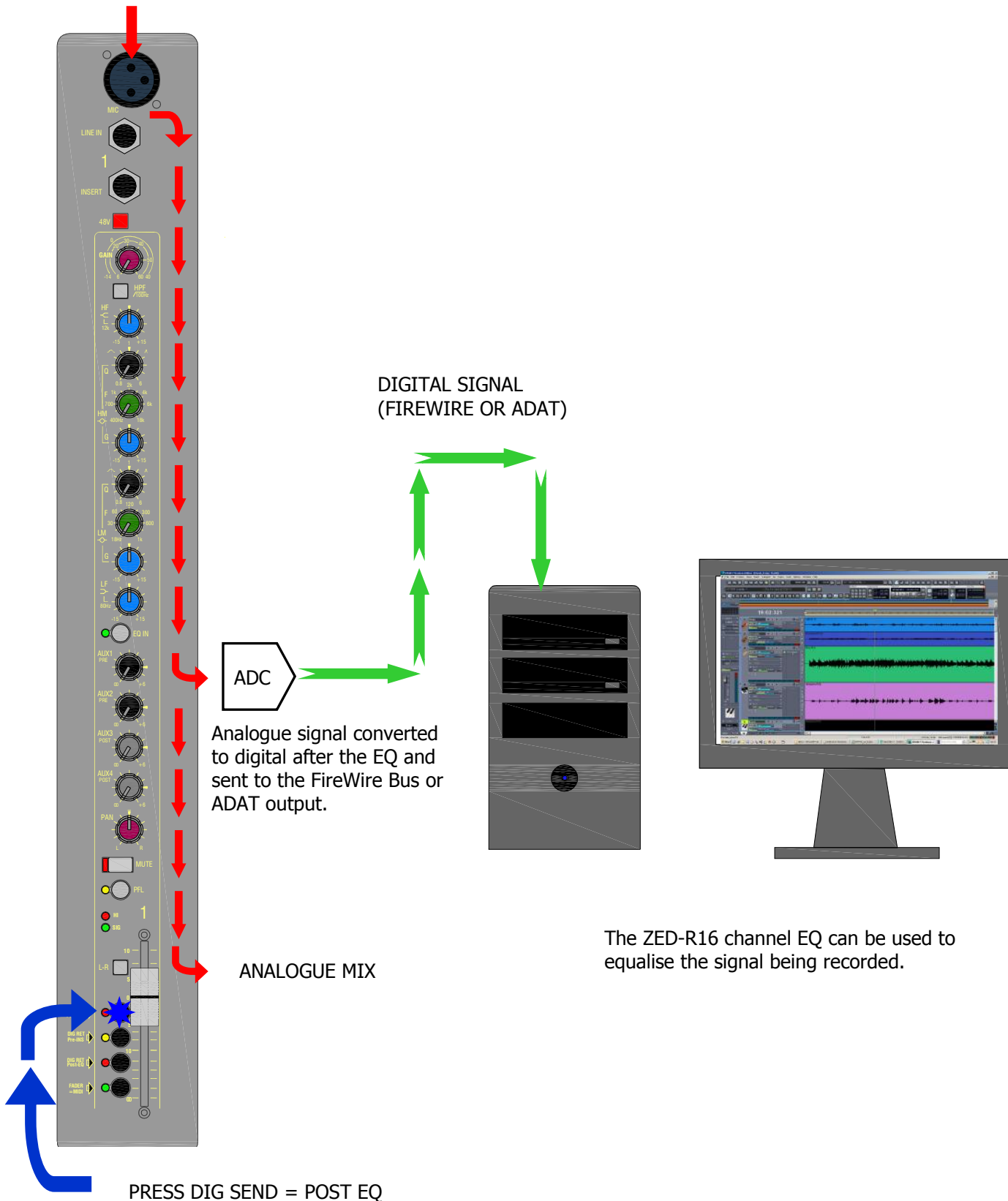

MODES OF OPERATION

USING DIGITAL PROCESSING PLUG-INS IN AN ANALOGUE MIX

The digital channel inputs and outputs are used to send a signal to the Digital Audio Workstation of software application where processing plug-ins such as noise gates or compressors can be used, almost as if they were plugged into the insert point on the channel.

ANALOGUE SIGNAL

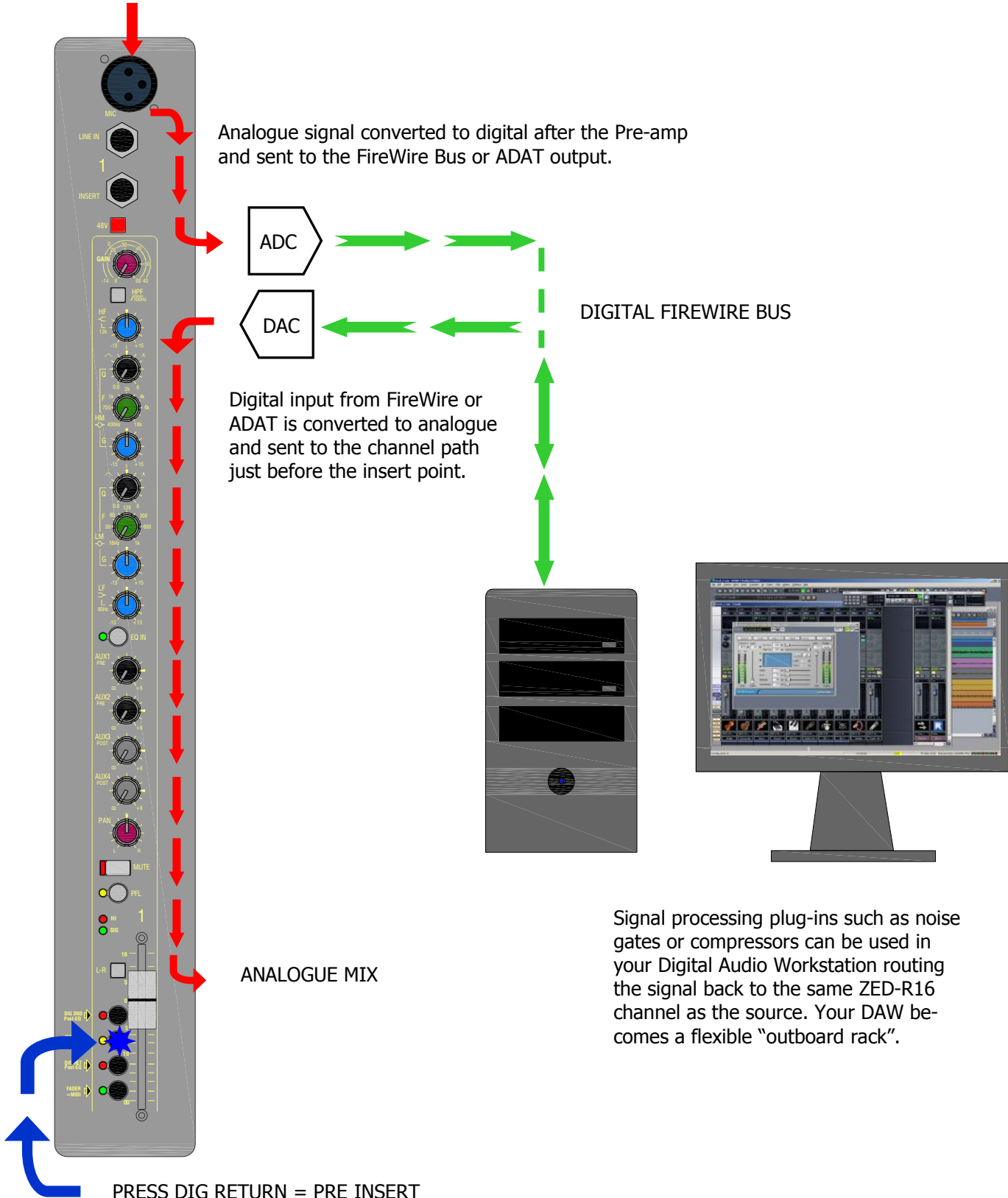

MODES OF OPERATION

IN LINE MULTITRACK RECORDING AND MONITORING

The signal for recording is sent pre EQ (it can be post EQ if the DIG SND = post EQ switch is pressed) and the track can be monitored by pressing the DIG RET = post EQ configuration switch. Using this mode emulates the traditional method of monitoring from the replay head of a tape machine which is a reliable way of monitoring what is being recorded.

ANALOGUE SIGNAL

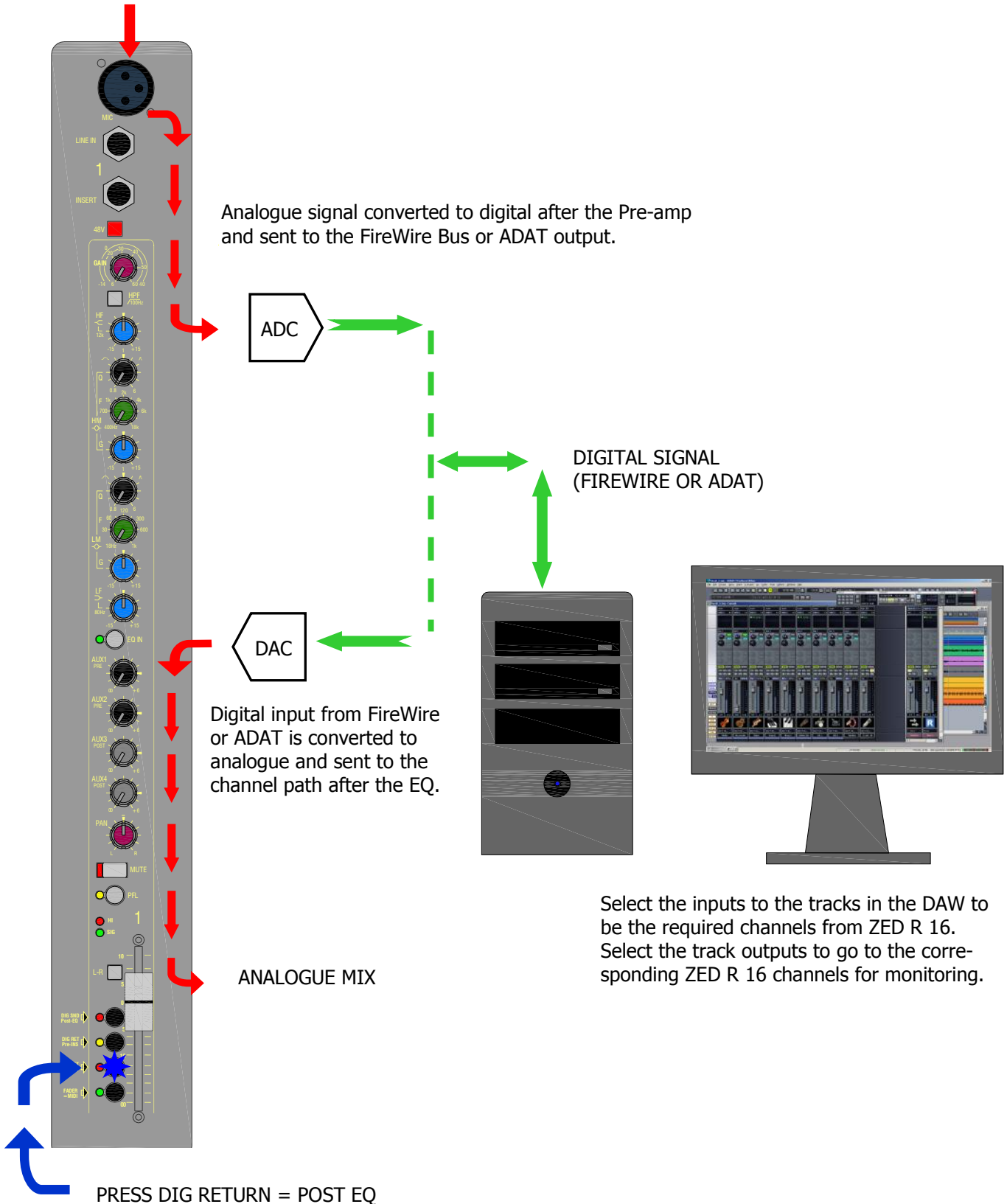

MODES OF OPERATION

ANALOGUE MIXDOWN FROM DIGITAL SOURCE

Here, the digital inputs to the channels are selected to go to the channel just before the insert point (replacing the signal from the pre-amp). This mode allows for analogue mixing from a multi-track digital source using the simply gorgeous analogue EQ on the ZED-R16.

It is also a great mode to use when overdubbing tracks, using the digital inputs for monitor & foldback purposes whilst using the PRE-INSert digital send to do the overdub recording.

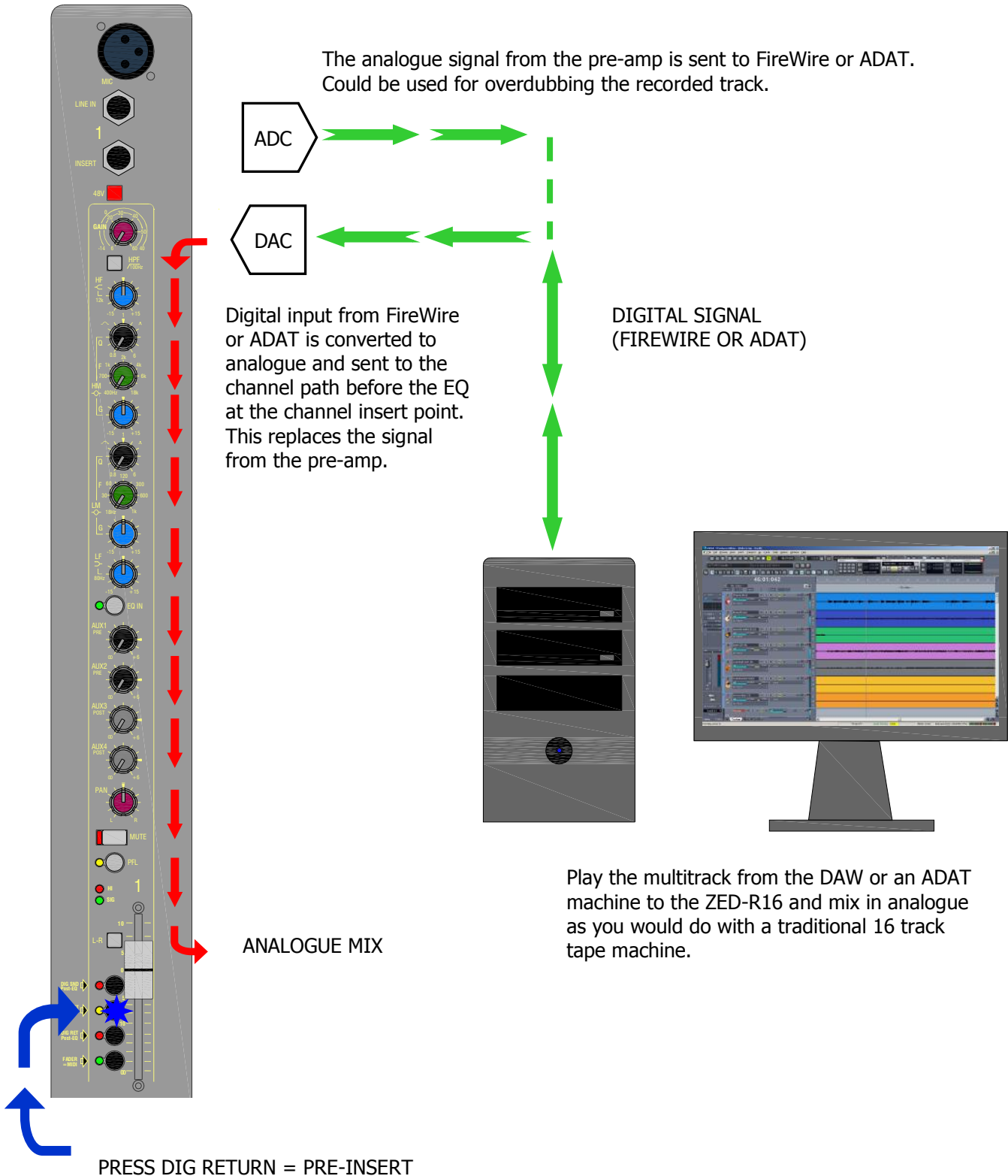

MODES OF OPERATION

DIGITAL MIXDOWN USING FADERS AS MIDI CONTROLLERS

Many people will want to stay in the digital domain once their tracks are recorded. The ZED-R16 appreciates this and allows the channel faders to be used as MIDI controllers where they can be assigned to control the level or other parameter within the Digital Audio Workstation or software application. The analogue part of the fader is bypassed at unity gain, so it is still possible to route signals to the mix bus if required. Also, the other parts of the channel are available for things like sending audio to the DAW for additional tracks or overdubbing whilst monitoring this signal using the Auxes, which would be at zero latency with respect to the input to the pre-amp.

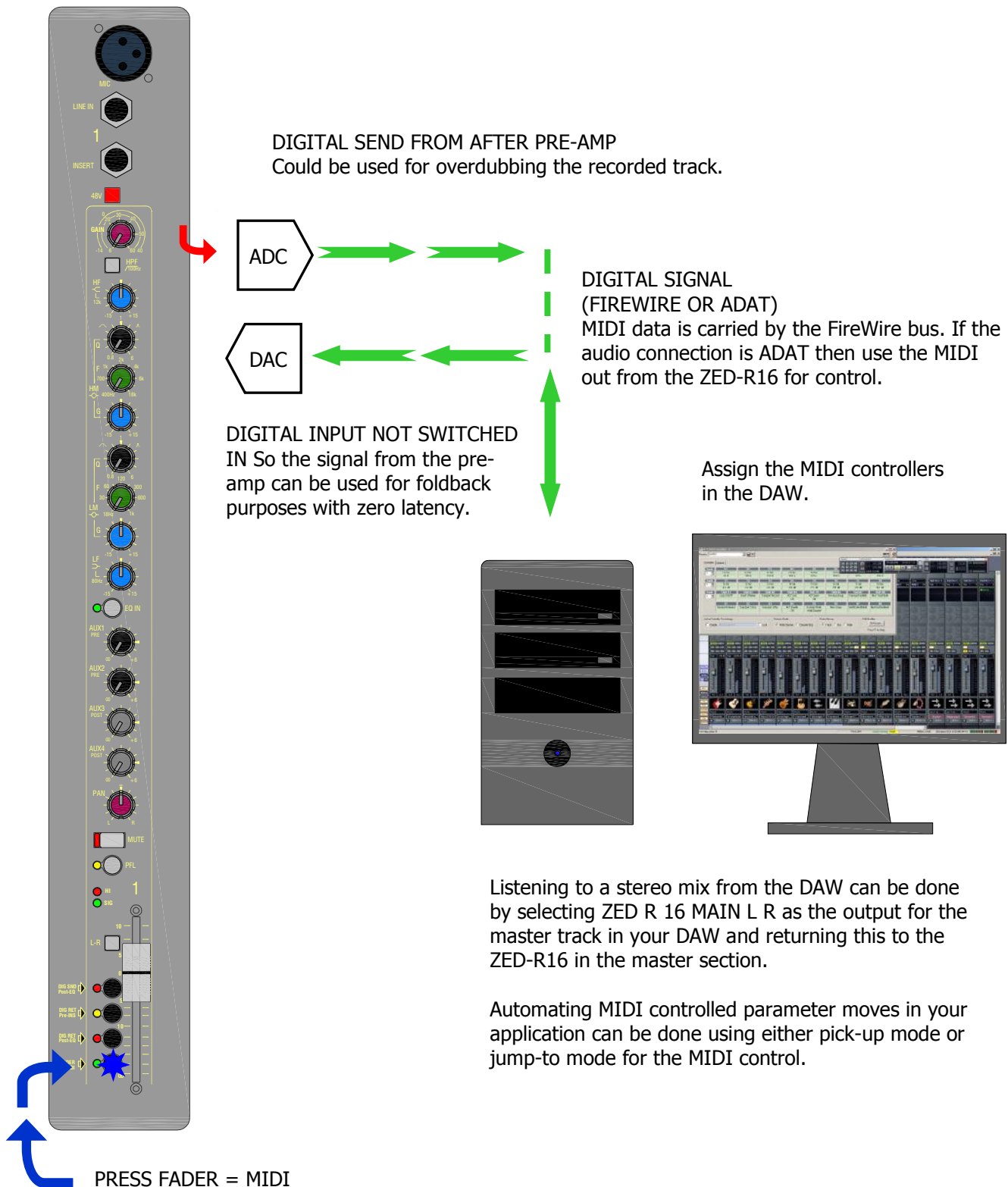

Listening to a stereo mix from the DAW can be done by selecting ZED R 16 MAIN L R as the output for the master track in your DAW and returning this to the ZED-R16 in the master section.

Automating MIDI controlled parameter moves in your application can be done using either pick-up mode or jump-to mode for the MIDI control.

MODES OF OPERATION

EXTREME FLEXIBILITY—ANALOGUE PLUG-INS!

You can even use the EQ in the ZED-R16 channel as an analogue plug-in for your Digital Audio Workstation! To do this press both the DIG RET = PRE INS to source the channel from your DAW and the DIG SND = POST EQ, so the output of the EQ goes back to the DAW. You may need to create a new track in your software application for the equalised audio, otherwise a feedback loop could easily be created between the ZED-R16 and the DAW.

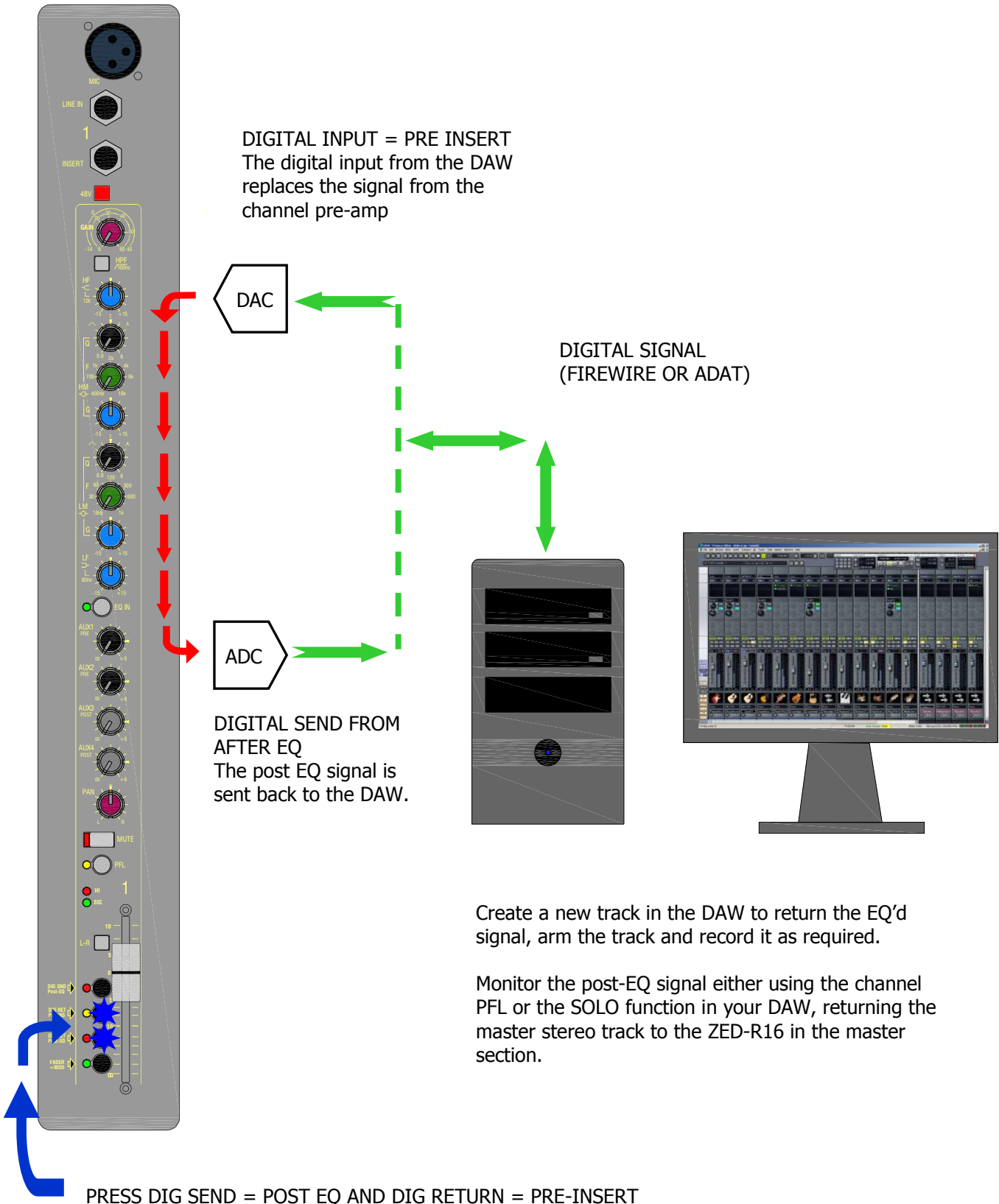

Create a new track in the DAW to return the EQ'd signal, arm the track and record it as required.

Monitor the post-EQ signal either using the channel PFL or the SOLO function in your DAW, returning the master stereo track to the ZED-R16 in the master section.



cakewalk SONAR LE

DIGITAL AUDIO WORKSTATION

SONAR LE Overview.

SONAR LE is a software application from Cakewalk and is included free of charge with your new ZED-R16 mixing console.

SONAR LE is a first step into the world of sequencing and hard disk recording on the Windows platform. You'll be able to record 8 tracks simultaneously from your ZED-R16 mixer, arrange songs, then play back 8 tracks simultaneously to your ZED-R16 mixer via the FireWire bus. You can decide whether the SONAR family of products is right for you. If you choose to upgrade your copy of SONAR LE to a more full-featured version, like SONAR Producer or Home Studio Editions, you'll now be able to do so at significant savings.

We will describe the basic steps of installing the software and getting started here, for more comprehensive help or technical support please use the Help files in SONAR LE or visit the SONAR LE website:

<http://www.cakewalk.com/owners/sonarle/>

The website will have details on registering your product and upgrading it should you wish. There are also tutorials to get you started.

SONAR LE is the most complete OEM production software solution available today. Unlike other OEM applications, SONAR LE has been designed to provide a simple yet complete solution for creating music. You won't feel the need to upgrade just to get started.

With support for up to 64 tracks and 24 track effects, 8 physical in/outs at 24bit/192kHz (96kHz maximum sample rate using ZED-R16), SONAR LE is able to offer a powerful pc based recording studio. The package also includes 2 instruments, 6 MIDI effects, and 14 audio effects.

SONAR LE has been updated with new features from its acclaimed SONAR Producer, making SONAR LE the first native Windows DAW for Windows XP, Windows x64, and Windows Vista.

SONAR LE Key Features.

64 audio tracks

256 MIDI tracks

8 simultaneous inputs and outputs

24-bit/192 kHz audio quality

24 simultaneous effects

8 simultaneous virtual instruments

Integrated VST/VSTi support, without need for VST adapter

Support for ACID™-format loops

Support for ReWire clients such as Project5, Live, or Reason

Elegant user interface

Active Controller Technology™ automatically maps MIDI keyboards and control surfaces to the parameters you need most on effects, instruments, volume, pan, and other mix elements

Easier integration of virtual instruments with Synth Rack

Support for Windows Vista (32-bit & 64-bit), Windows XP Professional x64 Edition, and

Windows XP operating systems

System Requirements (For SONAR LE)

(For running SONAR LE on a Windows computer. The system requirements for connecting to ZED-R16 are documented separately)

System Requirements	Minimum	Recommended
Operating System	Windows XP	Windows XP/Vista/Vista x64
Processor Speed	Intel® Pentium® 4 1.3 GHz, or AMD™ Athlon XP 1500+ or higher	Intel® Pentium® 4 2.8 GHz [EM64T], or AMD™ Athlon 64 2800+ or higher
RAM	256 MB	1 GB or higher
Graphics (resolution, color depth)	1024 x 768, 16-bit colour	1280 x 960, 32-bit colour
Hard Disk Space	100 MB for core program	2 GB for program and content
Hard Disk Type	Any	EIDE/Ultra DMA (7200 RPM) or SATA
MIDI Interface	Windows-compatible	Windows-compatible
Audio Interface	Windows-compatible	WDM- or ASIO-compatible, including WaveRT for Vista
Optical Drive	DVD-ROM, DVD+/-R, or DVD+/-RW for installation, CD-R or CD-RW capability required for CD audio disc burning	

SONAR LE Installation.

Put disk into CD or DVD ROM drive and follow instructions on screen.

SONAR LE Audio Configuration with ZED-R16.

To configure your SONAR LE software to communicate audio to and from your ZED-R16 mixing console, follow the sequence below.

Ensure the Driver software is installed on your computer. Please refer to the section titled Installing Drivers.

Ensure the ZED-R16 is powered on. Connect the FireWire lead from the computer to either FireWire port on ZED-R16.

First check that your computer has recognised the connection of the ZED-R FireWire device by clicking Settings/Control Panel/Sounds and Audio Devices/Audio.

ZED R Audio should appear as an option in the drop-down menu for Sound playback devices as shown on the right:

It is also a good idea to select “No Sounds” in the Sounds window so you don’t get the Windows beeps etc. through your monitors.

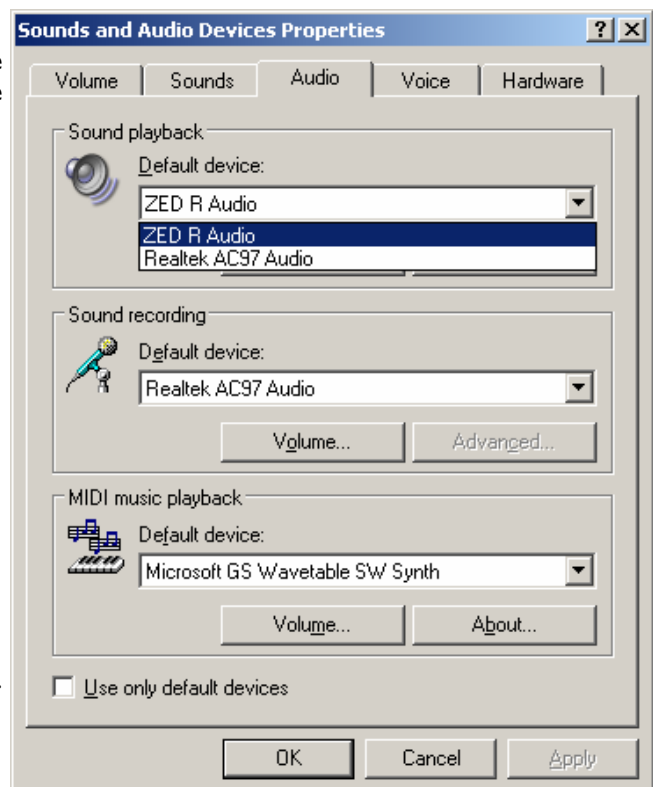

Next, launch SONAR LE.

Click Options/Audio and click on the Drivers tab. The Input and Output Drivers for ZED R should appear in the option boxes. If they don't, click the Advanced tab and check that the Driver Mode is set to ASIO.

The Input drivers are the audio sources to the computer. Using SONAR LE, only 8 simultaneous inputs can be used at one time and these are shown in the screenshot enabled in pairs. Unfortunately with the current version of SONAR LE, the inputs and outputs are only enabled in pairs, but the inputs can be chosen as a mono source in the application ie CH1/2 Left would be channel 1.

The Output Drivers are the audio outputs from the Computer. Again, only 8 of the 18 possible FireWire channels are enabled simultaneously using SONAR LE.

If you scroll down the list of Input & Output Drivers, you will see there are 8 ADAT input channels and 8 ADAT output channels that can be enabled as well as choosing from the 18 FireWire inputs and 18 outputs.

These can be enabled and used in conjunction with the 18 FireWire inputs and outputs, connecting ADAT equipment to the ADAT input and output connectors 1-8. SONAR LE will only allow 8 simultaneous inputs and 8 outputs at one time, so the ADAT channels will count towards that number, but with applications with a higher number of simultaneous inputs & outputs, then the number of FireWire and ADAT channels that can be used will be according to the table on p24.

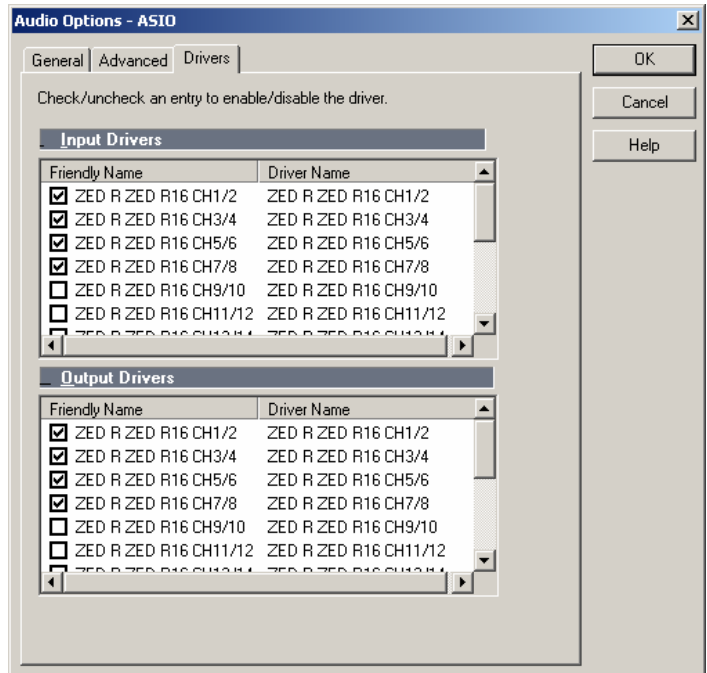

In order to show how to select inputs to SONAR tracks, here is a basic Cakewalk 16 track project (.cwp). This is created by clicking File/New/16 Track Audio. Click on the I/O tab near the bottom of the window, then click the expand buttons in the audio track panes. The track 1 shows the drop down menu for the track inputs and if we select LEFT ZED R16 CH1/2, then the source for that track will be channel 1 from ZED-R16.

If audio is present, click the Input Echo buttons (lit up yellow here) to monitor the signals on the Master Bus.

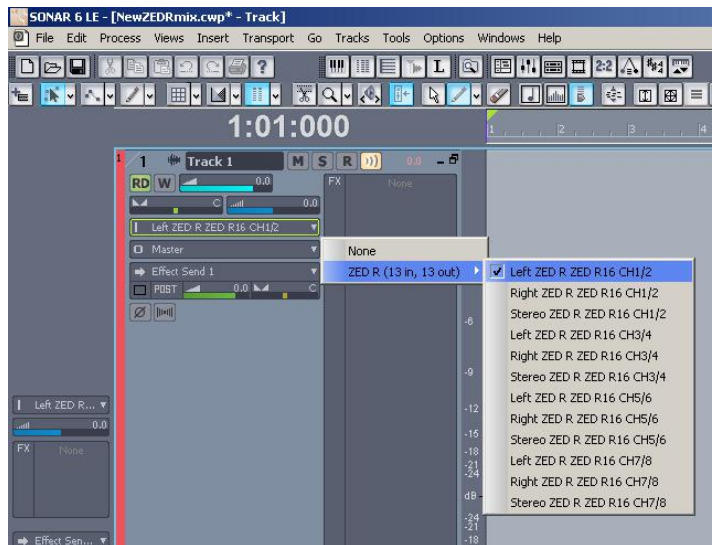

The output for of the track is automatically routed to the master bus in SONAR LE, but could be routed back to your ZED-R16 using the drop-down menu for the outputs. Note that in SONAR LE that there are only 8 outputs available simultaneously, in pairs. If a mono output is required then select the relevant pair and pan the output of that track to be a mono output, so to route back to ZED-R16 channel 1, select CH1/2 and pan 100% left.

You should now be able to send audio between your computer and your ZED-R16 using SONAR LE.

To test this, let's do a recording....

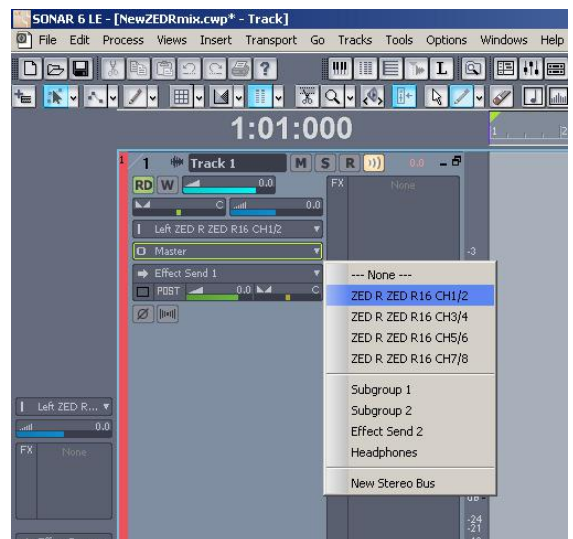

To record the audio on tracks 1 & 2, click the R buttons so they light up red, then the record button (circle) on the transport controls on the top icon toolbar. (Or select larger transport controls from Views). The audio wave profile will show in the track panes. Click stop (Square) when finished.

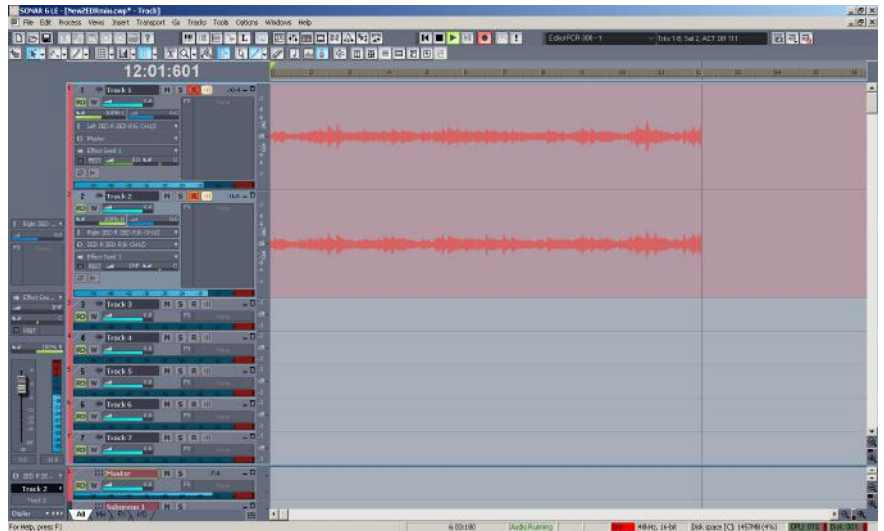

To listen to the recording, click rewind, then de-select the input echo buttons (to the right of the R buttons). Also disarm the tracks by de-selecting the R buttons.

Click Play (or spacebar) and the recorded audio should play to the selected outputs on the track which if you have selected CH1/2 and panned left for track 1 and CH1/2 panned right for track 2 will be the same channels on ZED-R16 supplying the audio to the tracks.

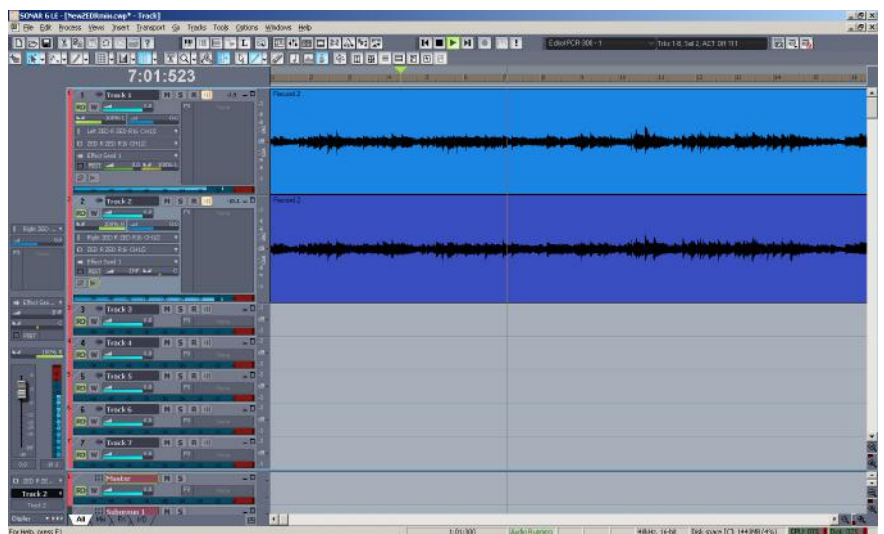

Dropouts and Latency

A common problem of a poorly set up digital audio system is audio dropout, either temporary or permanent, and clicks or artefacts. These can be caused by various inadequacies of the system which can be either hardware or software. If you experience audio dropouts or clicks, the first thing to do is to analyse your computer system and test its ability to process streamed audio data.

A good tool to use is the DPC checker described on p31, which checks for excessive computer processor timings caused by certain drivers or applications running on the computer. As a general guideline a DPC measurement of below 100uS should enable audio streaming to run with reasonable buffer sizes.

If excessively high measurements are reported by the DPC checker, it is a good idea to investigate the cause. Disconnect peripherals (ZED-R16, printers etc) and any network if possible and look for improvement. In addition it is often beneficial to disable drivers for unused network connections such as wireless network drivers. For more tips and diagnostic advice please check our website, or contact our Tech Support department by logging onto <http://allen-heath.helpserve.com>.

For many people low latency is important, especially for artists' monitoring purposes. ZED-R16 is ideal because it offers the ability to monitor the signal from the pre-amp using the Aux buses in the analogue domain, whilst recording to digital, providing zero latency foldback.

Sometimes low latency from the FireWire bus audio transfer is required, so as a guide here is a table showing latency figures at different sample rates and buffer sizes.

Sample Rate	Buffer Size	Each way latency
48kHz	128 bytes	4.5mS
48kHz	256 bytes	7ms
96kHz	256 bytes	4mS
96kHz	512 bytes	7mS

Enabling MIDI Control with SONAR LE

With SONAR LE running and ZED-R16 connected via FireWire, click Options in the main menu toolbar, then MIDI Devices. Enable ZED-R as a MIDI input device to SONAR by clicking on it as below.

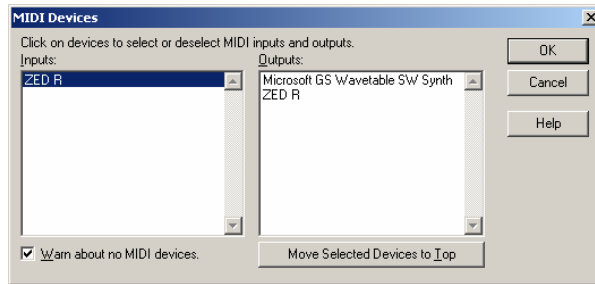

Click OK and return to the main Options menu and click Controllers/Surfaces where you can choose the MIDI control source for your project. If none appear then click the Add New button (yellow star) and select the controller surface type as MMC-I and the In port as ZED-R. This will set the MIDI Machine Control transport keys on ZED-R16 to operate the transport functions in SONAR LE. Click Add New again and select ACT MIDI Controller-I to be the controller and select the In port to ZED-R. The pane should look like:

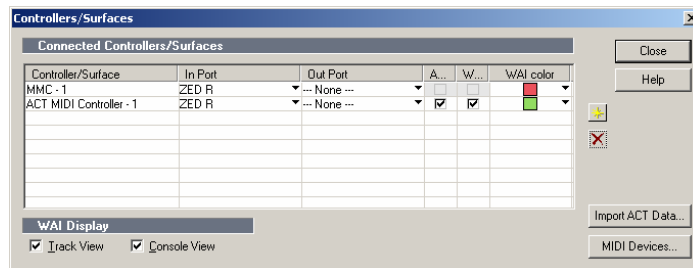

You are now able to assign the MIDI controllers on ZED-R to functions in SONAR LE. This is a very brief overview of how to get started, if you need to know more about MIDI control in SONAR LE, then the Cakewalk website is a great source of information. To get started though, click the Controller/Surface selection window on the main toolbar (you may need to enable it in Views/Toolbars), and select ACT MIDI Controller-I. Then to the right of this click the Controller/Surface Properties button and the controller properties assignment pane opens.

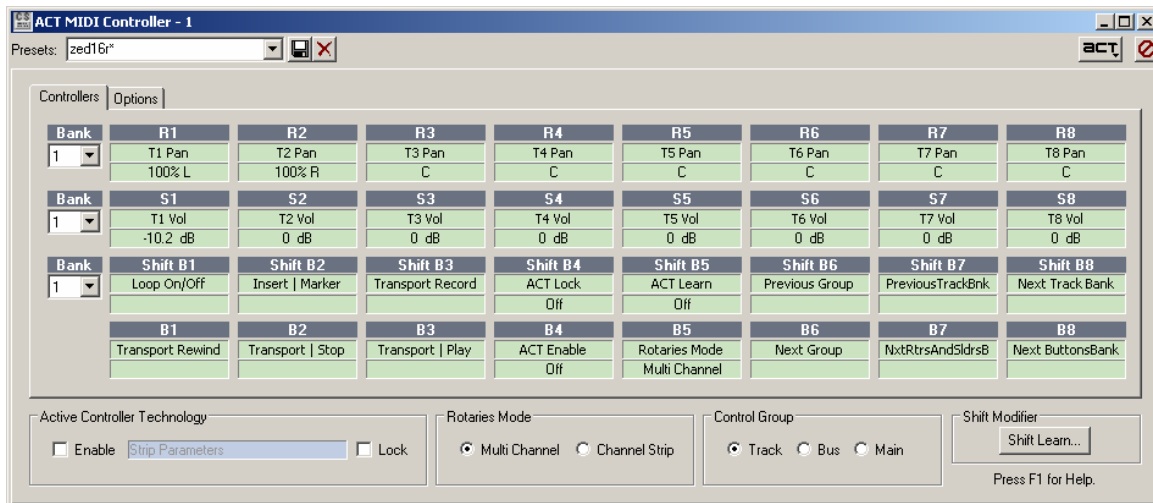

To assign the ZED-R channel I fader to control the fader on track I of the project we have open, click the lower half of the S1 pane just under T1 Vol. It is set to learn a MIDI controller. Press the CH I Fader=MIDI switch and move the fader and you will see the dB value changing and also the fader moving on track I.

The rotary MIDI controllers and MIDI switches on ZED-R can be assigned in a similar way, the controls being mapped to different functions in the Options tab and choosing from the menus.

ZED-R MIDI IMPLEMENTATION

MIDI CONTROLLER	MESSAGE TYPE	DATA 1	DATA 2
FADER CH1	CC	01	0-127
FADER CH2	CC	02	0-127
FADER CH3	CC	03	0-127
FADER CH4	CC	04	0-127
FADER CH5	CC	05	0-127
FADER CH6	CC	06	0-127
FADER CH7	CC	07	0-127
FADER CH8	CC	08	0-127
FADER CH9	CC	09	0-127
FADER CH10	CC	0A	0-127
FADER CH11	CC	0B	0-127
FADER CH12	CC	0C	0-127
FADER CH13	CC	0D	0-127
FADER CH14	CC	0E	0-127
FADER CH15	CC	0F	0-127
FADER CH16	CC	10	0-127
FADER MIDI 1	CC	11	0-127
FADER MIDI 2	CC	12	0-127
FADER MIDI 3	CC	13	0-127
FADER MIDI 4	CC	14	0-127
ROTARY 1	CC	65	0-127
ROTARY 2	CC	66	0-127
ROTARY 3	CC	67	0-127
ROTARY 4	CC	68	0-127
ROTARY 5	CC	69	0-127
ROTARY 6	CC	6A	0-127
ROTARY 7	CC	6B	0-127
ROTARY 8	CC	6C	0-127
ROTARY 9	CC	6D	0-127
ROTARY 10	CC	6E	0-127
ROTARY 11	CC	6F	0-127
ROTARY 12	CC	70	0-127

MIDI CONTROLLER	MESSAGE TYPE	DATA 1	DATA 2
SWITCH 1	NOTE ON/OFF	01	7F/00
SWITCH 2	NOTE ON/OFF	02	7F/00
SWITCH 3	NOTE ON/OFF	03	7F/00
SWITCH 4	NOTE ON/OFF	04	7F/00
SWITCH 5	NOTE ON/OFF	05	7F/00
SWITCH 6	NOTE ON/OFF	06	7F/00
SWITCH 7	NOTE ON/OFF	07	7F/00
SWITCH 8	NOTE ON/OFF	08	7F/00
SWITCH 9	NOTE ON/OFF	09	7F/00 *
SWITCH 10	NOTE ON/OFF	0A	7F/00 *
SWITCH 11	MMC		REWIND
SWITCH 12	MMC		STOP
SWITCH 13	MMC		PLAY
SWITCH 14	MMC		FFW
SWITCH 15	MMC		REC
SWITCH 16	NOTE ON/OFF	10	7F/00
SWITCH 17	NOTE ON/OFF	11	7F/00

* = Resends command if held down

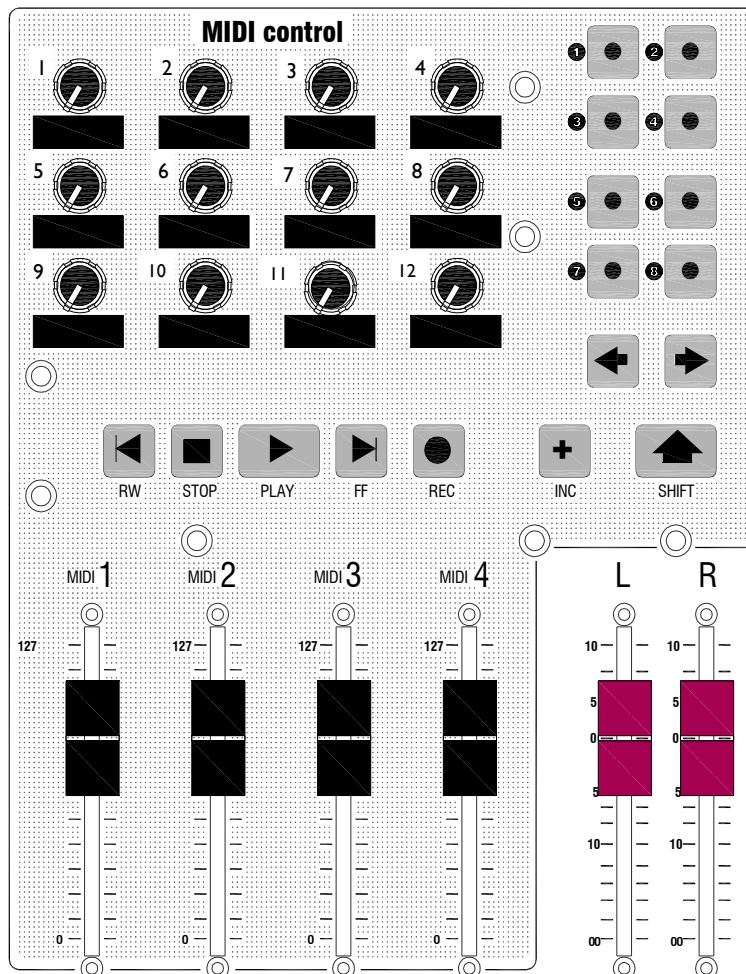

ZED-R MIDI IMPLEMENTATION

Changing MIDI Channel

The default MIDI channel is 16.

To change the MIDI channel follow the following procedure:

1. With ZED-R16 powered off, press & hold down the PLAY button and switch on the mains power to ZED-R16.
2. Release the PLAY button.
3. Press & hold down the MIDI switches 1,3,5 & 7 in a combination from the table below.
4. Press and release the PLAY button again.
5. Release the switches 1,3,5 & 7, if any are pressed from step 3.
6. Turn off the mains power.
7. Turn the mains power back on and the MIDI channel should be set to your required selection.

Table of switch 1,3,5 & 7 press for MIDI channel selection.

MIDI channel required.	Switch combination pressed
1	NONE
2	1
3	3
4	1+3
5	5
6	5+1
7	5+3
8	5+3+1
9	7
10	7+1
11	7+3
12	7+3+1
13	7+5
14	7+5+1
15	7+5+3
16	7+5+3+1

Notes on MIDI Channel selection.

The ZED-R16 will remember the MIDI channel that was last set on power up. The factory setting is CH16. The MMC Transport control message will be an "all call" or "all device ID" message if the ZED-R16 is set to transmit on MIDI channel 16. If set to transmit on MIDI channels 1 to 15, the MMC Transport control message will be specific to devices set to that MIDI channel.

WIRING NOTES

Insert cable wiring

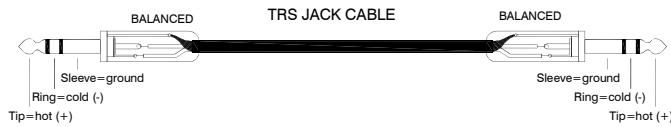
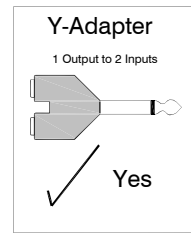
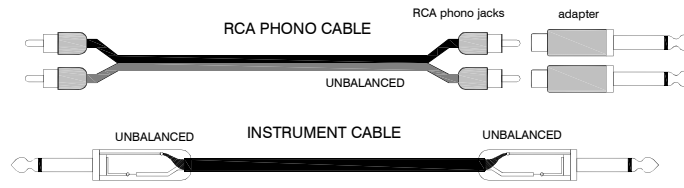
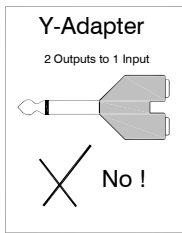
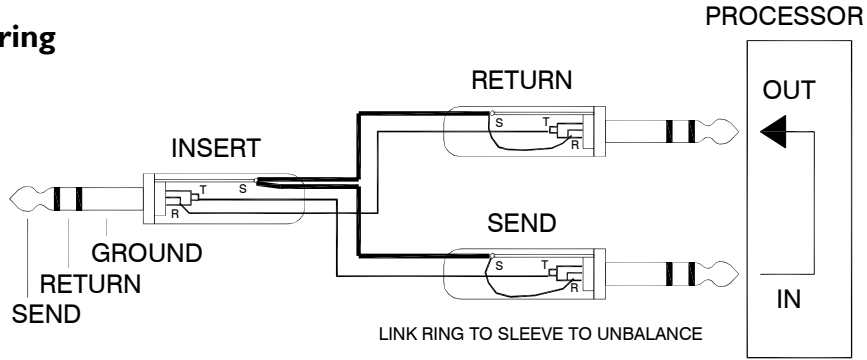

TO INPUT

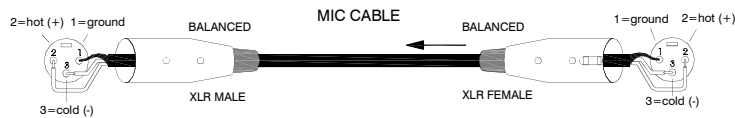

FROM OUTPUT

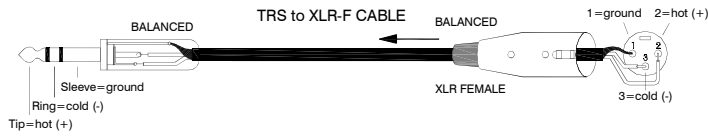

General Wiring Information

