



User Manual



DIGITAL SNAKE S16

I/O Box with 16 Remote-Controllable MIDAS Preamps,
8 Outputs and AES50 Networking featuring
KLARK TEKNIK SuperMac Technology

EN

Table of Contents

- Important Safety Instructions 3**
- Legal Disclaimer 3**
- Limited warranty 3**
- 1. Introduction 4**
- 2. Callouts..... 4**
- 3. Hookup Diagrams..... 5**
- 4. Configuring the S16..... 9**
 - 4.1 Standard Operation 10
 - 4.2 Cascaded Operation..... 10
- 5. Standalone Operation..... 12**
- 6. MIDI Communication 12**
- 7. Specifications 13**

EN Important Safety Instructions

Terminals marked with this symbol carry electrical current of sufficient magnitude to constitute risk of electric shock.

Use only high-quality professional speaker cables with ¼" TS or twist-locking plugs pre-installed. All other installation or modification should be performed only by qualified personnel.



This symbol, wherever it appears, alerts you to the presence of uninsulated dangerous voltage inside the enclosure - voltage that may be sufficient to constitute a risk of shock.



This symbol, wherever it appears, alerts you to important operating and maintenance instructions in the accompanying literature. Please read the manual.

**Caution**

To reduce the risk of electric shock, do not remove the top cover (or the rear section). No user serviceable parts inside. Refer servicing to qualified personnel.

**Caution**

To reduce the risk of fire or electric shock, do not expose this appliance to rain and moisture. The apparatus shall not be exposed to dripping or splashing liquids and no objects filled with liquids, such as vases, shall be placed on the apparatus.

**Caution**

These service instructions are for use by qualified service personnel only. To reduce the risk of electric shock do not perform any servicing other than that contained in the operation instructions. Repairs have to be performed by qualified service personnel.

1. Read these instructions.
2. Keep these instructions.
3. Heed all warnings.
4. Follow all instructions.
5. Do not use this apparatus near water.
6. Clean only with dry cloth.
7. Do not block any ventilation openings. Install in accordance with the manufacturer's instructions.
8. Do not install near any heat sources such as radiators, heat registers, stoves, or other apparatus (including amplifiers) that produce heat.

9. Do not defeat the safety purpose of the polarized or grounding-type plug. A polarized plug has two blades with one wider than the other. A grounding-type plug has two blades and a third grounding prong. The wide blade or the third prong are provided for your safety. If the provided plug does not fit into your outlet, consult an electrician for replacement of the obsolete outlet.

10. Protect the power cord from being walked on or pinched particularly at plugs, convenience receptacles, and the point where they exit from the apparatus.

11. Use only attachments/accessories specified by the manufacturer.



12. Use only with the cart, stand, tripod, bracket, or table specified by the manufacturer, or sold with the apparatus. When a cart is used, use caution when moving the cart/apparatus combination to avoid

injury from tip-over.

13. Unplug this apparatus during lightning storms or when unused for long periods of time.

14. Refer all servicing to qualified service personnel. Servicing is required when the apparatus has been damaged in any way, such as power supply cord or plug is damaged, liquid has been spilled or objects have fallen into the apparatus, the apparatus has been exposed to rain or moisture, does not operate normally, or has been dropped.

15. The apparatus shall be connected to a MAINS socket outlet with a protective earthing connection.

16. Where the MAINS plug or an appliance coupler is used as the disconnect device, the disconnect device shall remain readily operable.



TO BIND MUSIC GROUP BY ANY EXPRESS OR IMPLIED UNDERTAKING OR REPRESENTATION. THIS MANUAL IS COPYRIGHTED. NO PART OF THIS MANUAL MAY BE REPRODUCED OR TRANSMITTED IN ANY FORM OR BY ANY MEANS, ELECTRONIC OR MECHANICAL, INCLUDING PHOTOCOPYING AND RECORDING OF ANY KIND, FOR ANY PURPOSE, WITHOUT THE EXPRESS WRITTEN PERMISSION OF MUSIC GROUP IP LTD.

ALL RIGHTS RESERVED.

© 2013 MUSIC Group IP Ltd.

Trident Chambers, Wickhams Cay, P.O. Box 146, Road Town, Tortola, British Virgin Islands

LIMITED WARRANTY

For the applicable warranty terms and conditions and additional information regarding MUSIC Group's Limited Warranty, please see complete details online at www.music-group.com/warranty.

LEGAL DISCLAIMER

TECHNICAL SPECIFICATIONS AND APPEARANCES ARE SUBJECT TO CHANGE WITHOUT NOTICE AND ACCURACY IS NOT GUARANTEED. BEHRINGER, KLARK TEKNIK, MIDAS, BUGERA, AND TURBOSOUND ARE PART OF THE MUSIC GROUP (MUSIC-GROUP.COM). ALL TRADEMARKS ARE THE PROPERTY OF THEIR RESPECTIVE OWNERS. MUSIC GROUP ACCEPTS NO LIABILITY FOR ANY LOSS WHICH MAY BE SUFFERED BY ANY PERSON WHO RELIES EITHER WHOLLY OR IN PART UPON ANY DESCRIPTION, PHOTOGRAPH OR STATEMENT CONTAINED HEREIN. COLORS AND SPECIFICATIONS MAY VARY FROM ACTUAL PRODUCT. MUSIC GROUP PRODUCTS ARE SOLD THROUGH AUTHORIZED FULLFILLERS AND RESELLERS ONLY. FULLFILLERS AND RESELLERS ARE NOT AGENTS OF MUSIC GROUP AND HAVE ABSOLUTELY NO AUTHORITY

1. Introduction

The S16 Digital Snake is a 16-in, 8-out stagebox that features AES50 networking with KLARK TEKNIK SuperMac technology. Designed with multiple scenarios in mind, the S16 works equally well as a stand-alone pair for use with analog mixing consoles, or as part of the trio of BEHRINGER's digital mixing solution along with the X32 digital mixer and P16 personal monitoring system.

The 16 MIDAS-designed XLR inputs are fully programmable and remote-controllable from the X32. 8 balanced XLR outputs provide ample sends to the stage for mains and monitoring. The front panel also allows the level and phantom power to be controlled for all inputs and outputs, accompanied by an 8-LED meter and 7-segment display. The currently selected channel can be monitored via ¼" headphone jack with level control.

Dual AES50 jacks allow transmission of all audio and MIDI data to the FOH X32 with a single Ethernet cable, and also allow up to 3 S16s to be cascaded for maximum channel count. In this scenario, 48 bidirectional audio channels at 24-bit / 48 kHz can be transferred on just one CAT5 line between FOH and stage, including 48 analog inputs from stage, 24 analog outputs on stage as well as the 16 Ultranet channels, MIDI data and head amp remote control.

An additional Ultranet output provides the 16 channels for use with BEHRINGER's P16 personal monitoring system via Ethernet cable, allowing each musician to dial in their own custom mix from the stage. A pair of ADAT ports can carry additional sends to the stage beyond the 8 analog outputs, or split the 16 inputs. Lastly, a USB jack allows for future firmware updates.

2. Callouts

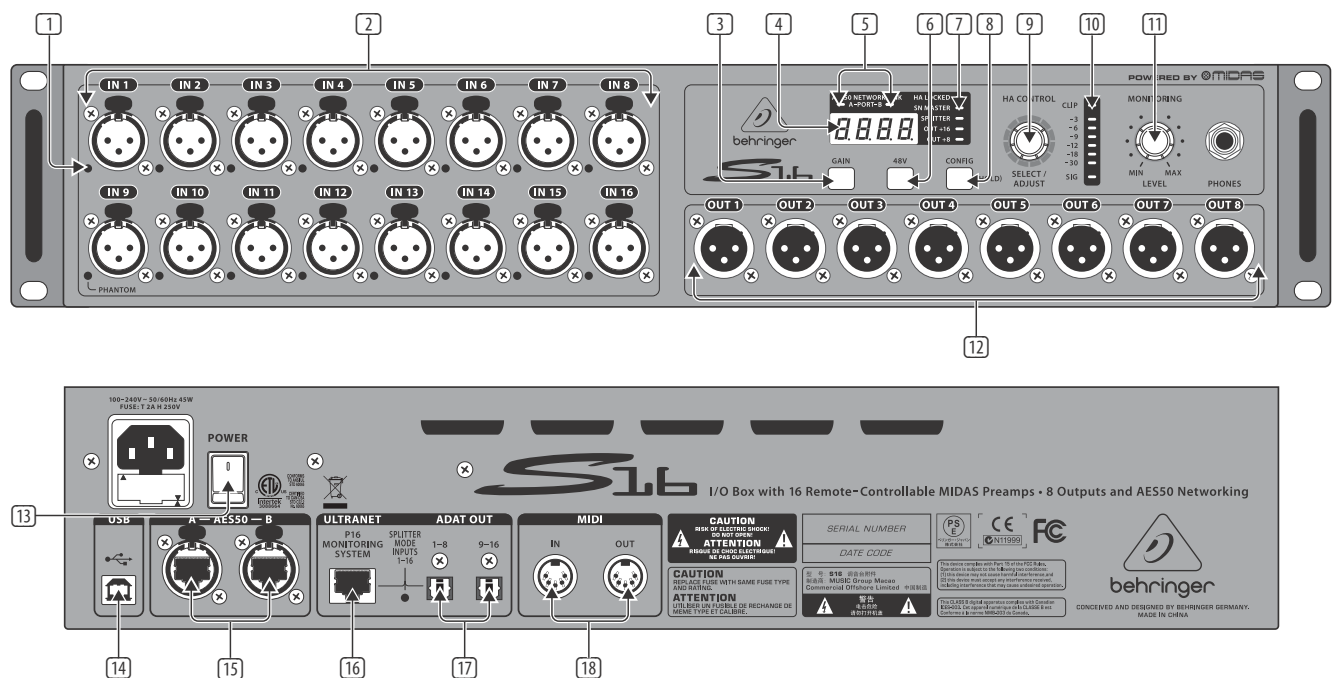

- 1 PHANTOM LEDs light when the 48 V button is engaged for a particular channel.
- 2 MIDAS-designed mic/line inputs accept balanced XLR male plugs.
- 3 GAIN button, when pressed and held, displays the currently selected mic input's gain setting, which may then be adjusted using the SELECT/ADJUST knob.
- 4 DISPLAY shows the selected channel number, its gain setting, or the sample rate in Snake Master configuration.
- 5 NETWORK LINK LEDs light red to indicate the AES50 ports are connected but not synchronized, and light green to indicate they are connected and synchronized.
- 6 48 V button sends phantom power to the currently selected mic input, indicated by a lit button when active.
- 7 STATUS LEDs show the operation mode of various features. See the Operation Mode Chart for details. The HA LOCKED LED indicates that preamp gain adjustment has been blocked by the controlling X32. To unlock, open the X32 Setup/Global page and un-check the General Preference 'Lock Stagebox'.
- 8 CONFIG button, when pressed and held, allows the device's operation mode to be adjusted by the SELECT/ADJUST knob. See Operation Mode Chart for details.
- 9 SELECT/ADJUST knob scrolls through the 16 channels, adjusts the gain of the currently selected input, and changes the operating mode. Push repeatedly to scroll **Inputs**, **Outputs**, **P16** channels, **ADAT** outputs, and **Stage** (only in Snake Master mode).
- 10 LED METER displays the signal level of the currently selected channel.
- 11 MONITORING LEVEL knob adjusts the level of the PHONES output.
- 12 XLR outputs accept balanced XLR female plugs.
- 13 POWER switch turns the unit on and off.
- 14 USB input accepts a USB type-B plug for firmware updates via PC.
- 15 AES50 ports allow connection to a SuperMAC digital multichannel audio network via shielded Cat-5e Ethernet cable with terminated ends. This allows connection to digital mixers or cascading of multiple S16 units.
- 16 ULTRANET port sends 16 channels to a Behringer P-16 personal monitoring system.
- 17 ADAT OUT jacks send AES50 channels 17-32 to external equipment via optical cable, or split the local 16 inputs for direct ADAT recording.
- 18 MIDI IN/OUT jacks accept standard 5-pin MIDI cables for MIDI communication to and from an X32 console.

3. Hookup Diagrams

Common connections

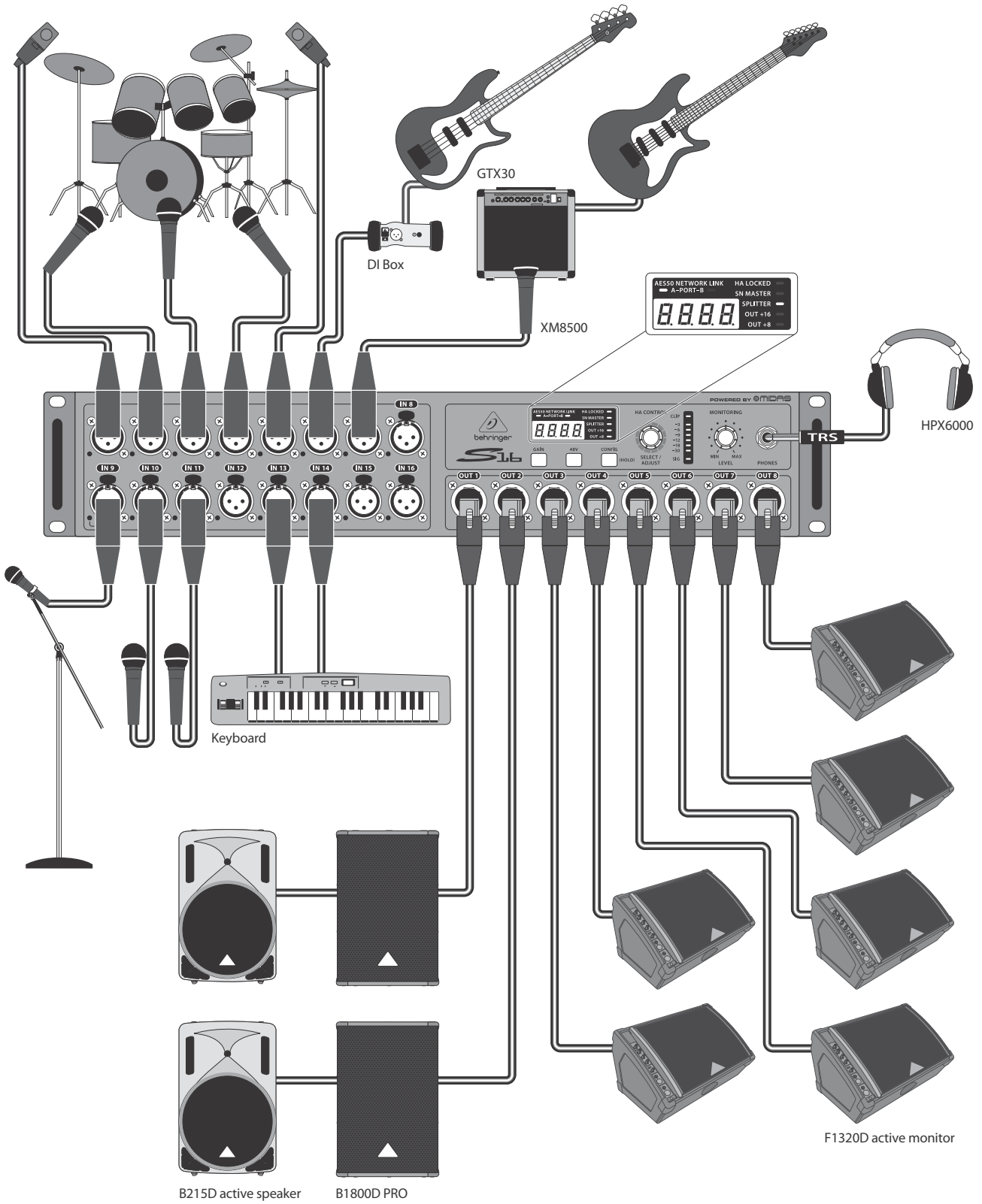

Rear panel connections

Cabling for all AES50 connections between X32 and S16 stageboxes:
 - Shielded Cat-5e cables only
 - Ethercon terminated cable ends
 - Maximum cable length 100 meters (300 feet)

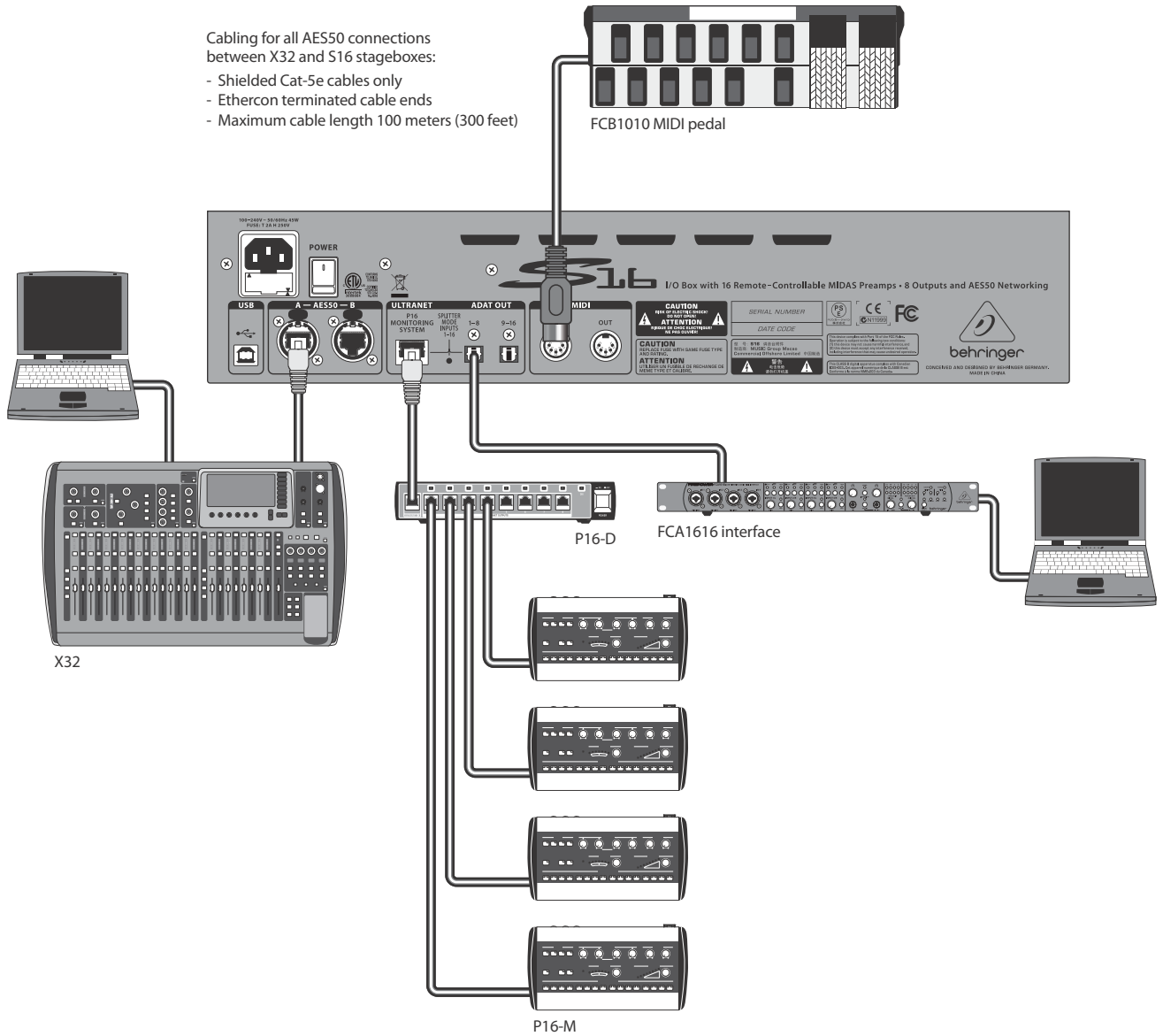

S16 as standalone snake

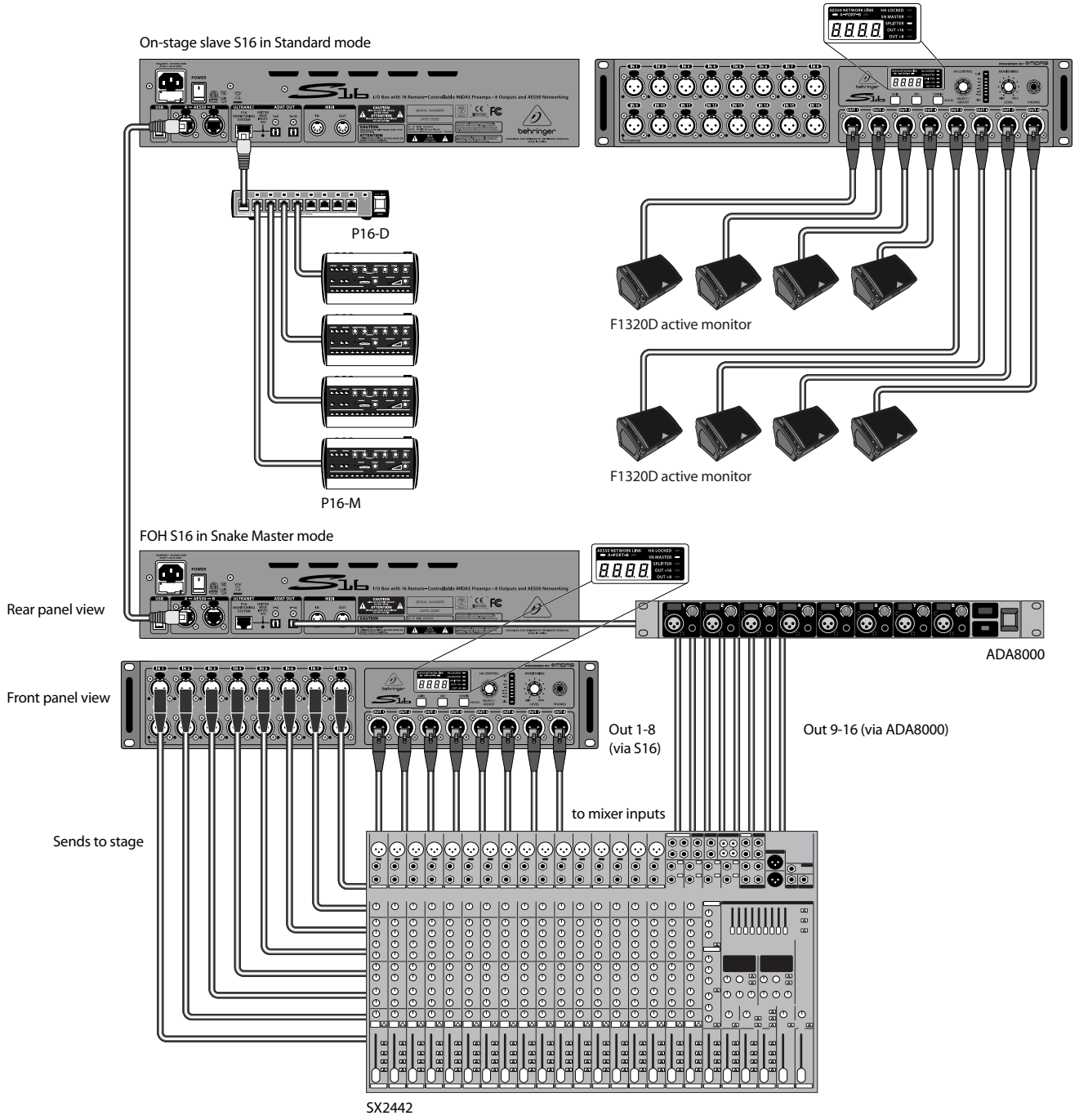

Linking two S16 units

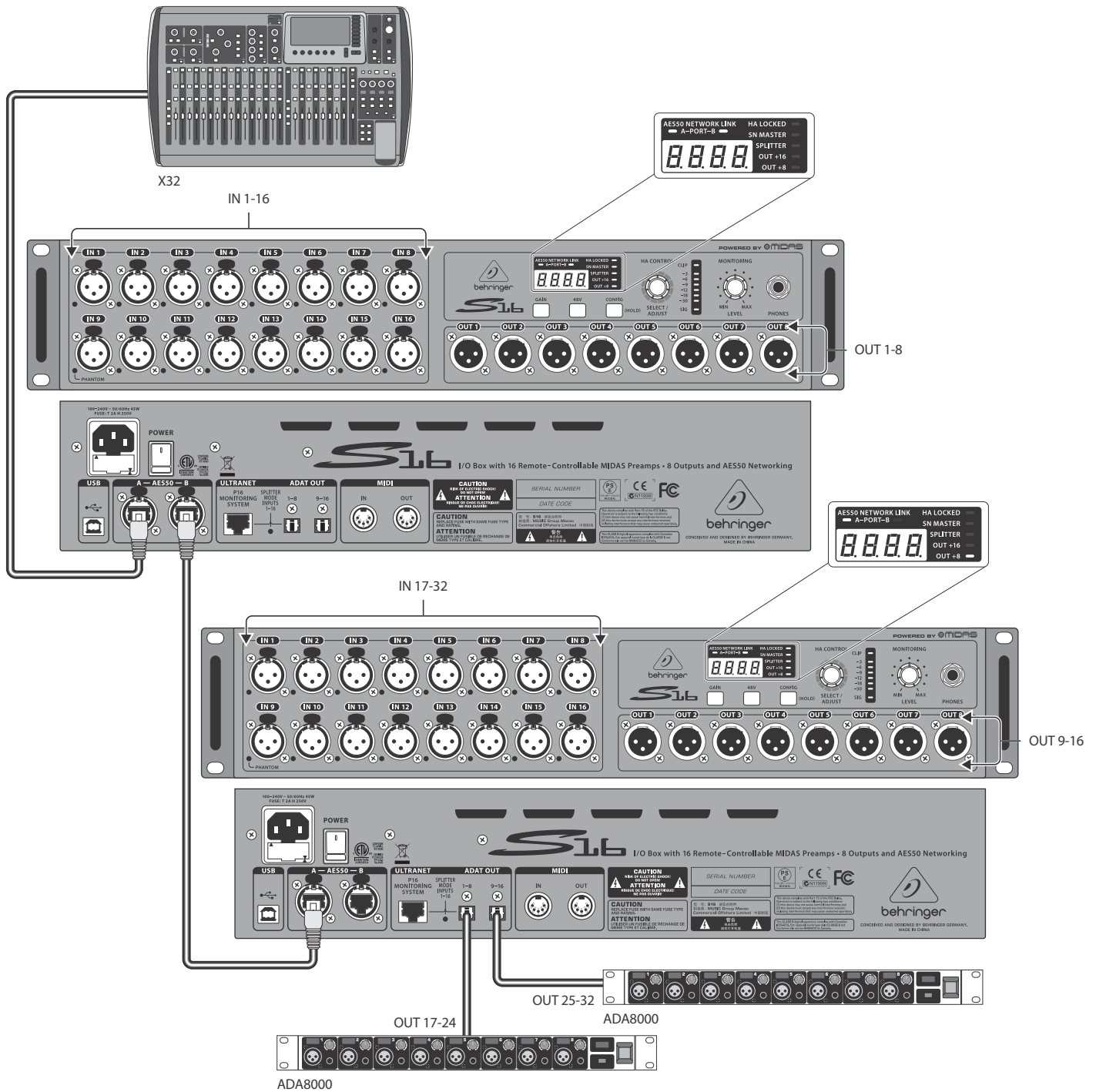

Note: The signals on both S16 units (Out 1-8 and 9-16) and both ADA8000 units (Out 17-24 and 25-32) are fully defined on the X32's 'Routing/AES50 Output' page. The second S16's outputs must be set to Out +8 on the unit itself.

4. Configuring the S16

By using the CONFIG button and SELECT/ADJUST knob, the S16 can be configured to suit many different applications. The STATUS LEDs indicate the current settings. By holding the CONFIG knob while turning the SELECT/ADJUST knob, you can scroll through all 10 configuration options. See the Operation Mode Chart for the routing details of each configuration setting.

When using multiple S16 units, activating SN(ake) MASTER mode on one unit allows that unit to control the preamp gain of the second unit. An S16 set to SN MASTER will also dictate the overall clock synchronization (44.1 or 48 kHz). This is useful when using a pair of S16s as a standalone digital snake (16 x 16) or a 32-channel mic preamp via ADAT. See the 'Standalone Operation' section for details.

SPLITTER mode routes the 16 local analog inputs directly to the ADAT outputs and P16 output. This is useful when using the S16 as a standalone snake where the P16 monitor mix cannot be adjusted from an X32 console. Additionally, the S16 can be used as a high-quality mic preamp that sends the 16 inputs to an interface or computer with an ADAT card for recording purposes. When SPLITTER mode is off, the ADAT outputs carry AES50 channels 17-32 and the P16 output carries channels 33-48.

The OUT +8 and OUT +16 options shift the XLR outputs for use with multiple S16s. For example, if a connection scenario involves 3 daisy-chained S16s, the first unit will carry AES50 channels 1-8. The second unit should be set to OUT +8 so that its analog outputs carry channels 9-16, and the 3rd S16 should be set to OUT +16 so that its analog outputs carry channels 17-24. This way you can provide up to 24 return signals to the stage. Alternatively, you may also use the same block of 8 output signals on a set of distributed S16 stageboxes.

DIGITAL SNAKE S16 Operation Mode Chart

Seq.	LED SN MASTER	sync clock	LED SPLITTER	LED OUT +16	LED OUT +8	XLR analog out 1-8	ADAT out 1-8	ADAT out 9-16	P-16 Ultramet out 1-16
1 (default)		AES50 (console)				= AES50-A, ch01-ch08	= AES50-A ch17-ch24	= AES50-A ch25-ch32	= AES50-A ch33-ch48
2		AES50 (console)			on	= AES50-A ch09-ch16	= AES50-A ch17-ch24	= AES50-A ch25-ch32	= AES50-A ch33-ch48
3		AES50 (console)		on		= AES50-A ch17-ch24	= AES50-A ch17-ch24	= AES50-A ch25-ch32	= AES50-A ch33-ch48
4		AES50 (console)	on			= AES50-A, ch01-ch08	= Local In 01 - 08	= Local In 09 - 16	= Local In 01 - 16
5		AES50 (console)	on		on	= AES50-A ch09-ch16	= Local In 01 - 08	= Local In 09 - 16	= Local In 01 - 16
6		AES50 (console)	on	on		= AES50-A ch17-ch24	= Local In 01 - 08	= Local In 09 - 16	= Local In 01 - 16
7	on	48 kHz (int)				= AES50-A, ch01-ch08	= AES50-A, ch01-ch08	= AES50-A ch09-ch16	= AES50-A ch01-ch16
8	on	44.1 kHz (int)				= AES50-A, ch01-ch08	= AES50-A, ch01-ch08	= AES50-A ch09-ch16	= AES50-A ch01-ch16
9	on	48 kHz (int)	on			= AES50-A, ch01-ch08	= Local In 01 - 08	= Local In 09 - 16	= Local In 01 - 16
10	on	44.1 kHz (int)	on			= AES50-A, ch01-ch08	= Local In 01 - 08	= Local In 09 - 16	= Local In 01 - 16

4.1 Standard Operation

The S16 is in Standard (default) mode when all the configuration STATUS LEDs on the front display are off. This is useful for using the unit as a digital snake along with the X32 console to conveniently transfer 16 channels from the stage to FOH, and send 40 total channels back to the stage. The sends to the stage are arranged as AES50 channels 1-8 which appear on the 8 analog XLR OUTPUTS, AES50 channels 17-24 and 25-32 which appear on the ADAT OUTPUTS, and AES50 channels 33-48 appearing at the P16 OUTPUT. The specific routing of the AES50 channels can be configured on the X32.

4.2 Cascaded Operation

To make use of the S16's full potential, up to 3 units can be cascaded to allow 48 channels of bidirectional audio. Any AES50 signals cascaded from one S16's port A to another S16's port B are automatically shifted up 16 channels, allowing the last S16 in the chain to transmit all audio channels to and from the stage via its AES50-A port. The X32 Routing home page allows selection of the incoming AES50 signals that can be connected to the channel processing. The routing of the audio sent from console to stage box can be adjusted on the X32 Routing AES50 pages, respectively.

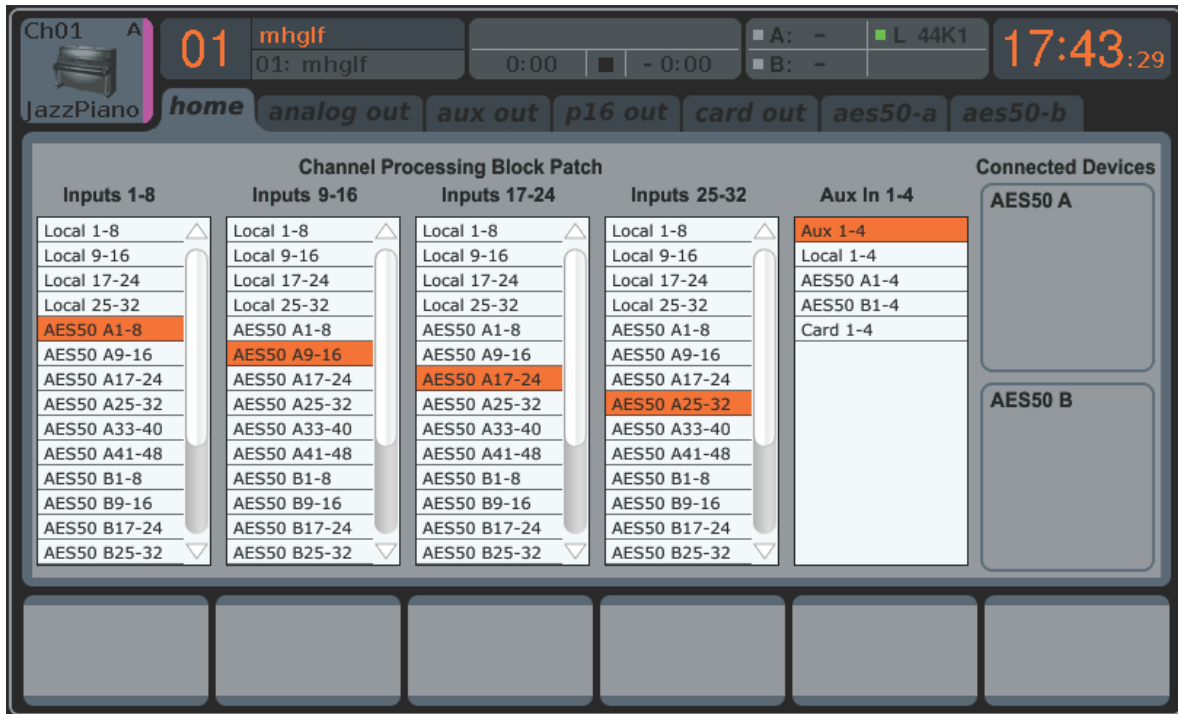

Signals sent from the X32 to the stage are seen the same on all S16 units in the chain. AES50 channels 1-8 will appear on the XLR OUTPUTS of each unit. To achieve maximum output to the stage, the 2nd and 3rd units in the chain must have their physical OUTPUTS set to OUT +8 and OUT +16 respectively.

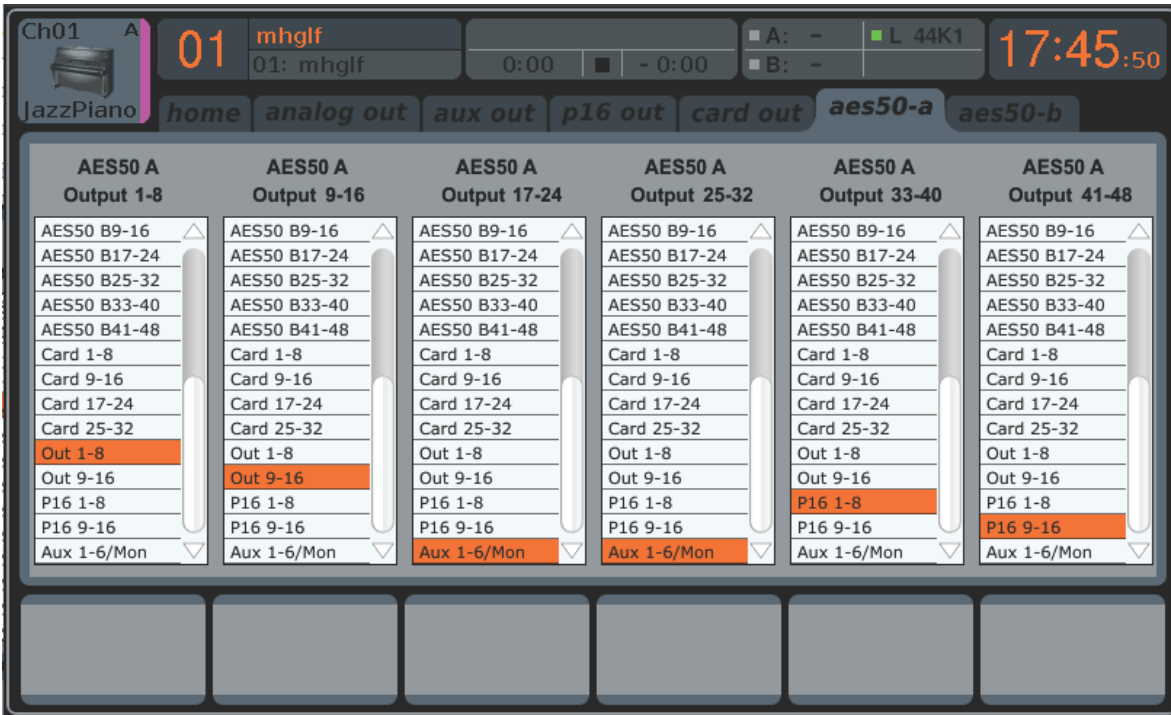

The following chart details the signal flow to and from the stage when using 3 S16 units.

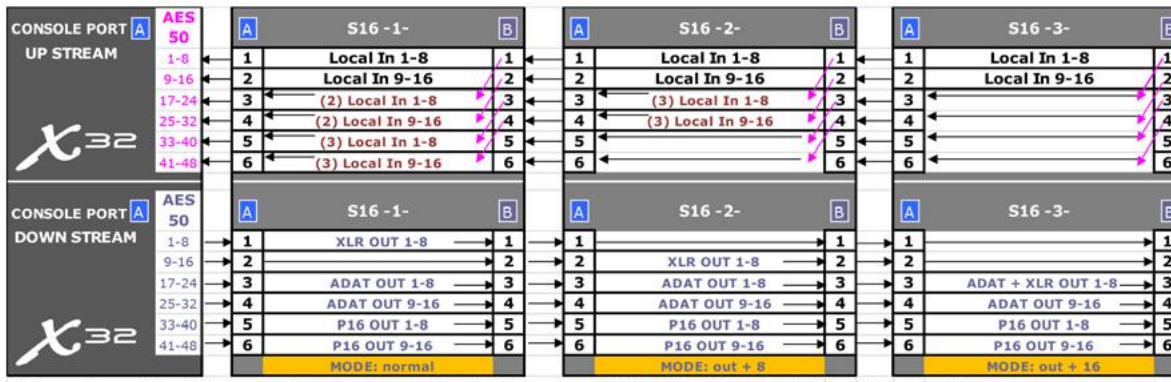

FOH console supplies clock synchronization and controls the S16 preamps exclusively (local HA control is blocked by console)



5. Standalone Operation

The S16 does not necessarily need to be used in conjunction with the X32 console. A pair of S16 units can be linked to send 16 channels to and from the stage, providing a high-quality digital snake that can work with any analog mixer.

In this scenario, a master S16 will be placed at FOH near the main mixing console, and the other on the stage (see 'S16 as standalone snake' hookup diagram). The FOH unit must be set to SN MASTER mode so that it can control the preamps of the unit on stage. All sends from FOH to the stage can be connected to INPUTS 1-8 on the 'master' S16, which will appear at the on-stage unit's XLR OUTPUTS. Connect all the sound sources from the performers to INPUTS 1-16 of the on-stage S16. Channels 1-8 will appear at the 'master' S16's XLR OUTPUTS and channels 9-16 will appear at the ADAT OUTPUT. Connect the ADAT 9-16 OUTPUT to an ADA8000 or similar preamp to provide analog XLR outputs. The outputs from the 'master' S16 and the ADA8000 can be connected to any sort of main console for mixing, analog or digital.

Note - when using a pair of S16 units as a standalone digital snake, the master unit at FOH is able to control the mic gains of the unit(s) on stage. However, in order to do so, one must press the SELECT/ADJUST button on the master unit so that the display reads "St 1".

For recording applications, a single S16 can also be used as a high-quality mic preamp. Connect the sound sources to the INPUTS 1-16, and send those channels via ADAT to an interface or ADAT card installed in your computer. For this scenario, the S16 must be set to SPLITTER mode.

6. MIDI Communication

The S16 head amp gain and phantom power settings can be controlled remotely via MIDI whenever it is used standalone, independent from X32 console products.

Note: The S16 will only accept MIDI controls when its preamps are not controlled via AES50 already. Connection to an X32 series console or another S16 in SN Master mode will always inhibit reception of preamp related MIDI commands.

The standard channel for transmit/receive of MIDI controls is 1. MIDI channel 2 is used when the SN slave unit is to be controlled via the SN Master unit.

Select	TRANSMIT / RECEIVE			Description
	CC #	Value	Channel	
SN MASTER "In 1-16" (FOH)	80...95	0...19	1	Controls local head amps of master unit Gain In 1-16, -2.5...+45 dB, 2.5 dB steps 48V Phantom 1-16 on/off
	96...111	0, 127	1	
SN MASTER "St 1-16" (Stage)	80...95	0...19	2	Controls remote head amps of slave unit Gain In 1-16, -2.5...+45 dB, 2.5 dB steps 48V Phantom 1-16 on/off
	96...111	0, 127	2	
SN SLAVE	-	-	-	No MIDI transmission or reception when controlled by SN Master or X32 console
Ext Sync w/o AES50 preamp control	80...95	0...19	1	Gain In 1-16, -2.5...+45 dB 48V Phantom 1-16 on/off
	96...111	0, 127	1	

Note: The string 0xEE, 0x7E, 0x7E can be sent for testing if an S16 is communicating via MIDI. The response would be 0xEE, 0x7E, 0x7F when MIDI inputs and outputs of S16 are connected to the test interface.

7. Specifications

Processing

A/D-D/A conversion (Cirrus Logic A/D CS5368, D/A CS4385)	24-bit @ 44.1 / 48 kHz, 114 dB dynamic range
---	---

Networked I/O latency (stagebox in > console processing* > stagebox out)	1.1 ms
--	--------

Connectors

XLR inputs, programmable mic preamps, designed by MIDAS	16
--	----

XLR outputs	8
-------------	---

Phones outputs, ¼" TRS	1 (mono)
------------------------	----------

AES50 ports, SuperMAC	2
-----------------------	---

P-16 connector, Ultranet (no power supplied)	1
---	---

MIDI inputs / outputs	1 / 1
-----------------------	-------

ADAT Toslink outputs (2x 8 Ch)	2
--------------------------------	---

USB type B, rear panel, for system updates	1
---	---

Mic Input Characteristics

Design	MIDAS
THD + noise, 20 dB gain, 0 dBu out	< 0.006 % A-weighted
Input impedance XLR, unbal. / bal.	5 kΩ / 10 kΩ
Non clip maximum input level, XLR	+23 dBu
Phantom power, switchable per input	48 V
Equivalent input noise level, XLR (input shorted)	-128 dBu
CMRR, XLR, @ 20 dB gain (typical)	> 70 dB
CMRR, XLR, @ 40 dB gain	> 80 dB

Input/Output Characteristics

Frequency range, @ 48 kHz sample rate, 0 dB to -1 dB	10 Hz - 22 kHz
Dynamic range, analog in to analog out (typical)	106 dB
A/D dynamic range, preamp and converter (typical)	109 dB
D/A dynamic range, converter and output	108 dB
Cross talk rejection @ 1 kHz, adjacent channels	100 dB
Output level, XLR, nom./max.	+4 dBu / +21 dBu
Output impedance, XLR, unbal. / bal.	75 Ω / 75 Ω
Phones output impedance / level	40 Ω / +25 dBm (mono)
Residual noise level, XLR and TRS	-87 dBu A-weighted

Indicators

Display	4-digit, 7-segment, LED
---------	-------------------------

Front status LEDs	AES50-A, red/green AES50-B, red/green HA Locked, red SN Master, green Splitter, orange Out +16, orange Out +8, orange
-------------------	---

Meter	Sig, -30 dB, -18 dB, -12 dB, -9 dB, -6 dB, -3 dB, Clip
-------	---

Rear panel	Splitter mode, orange
------------	-----------------------

Power

Switch-mode autorange power supply	100-240 V (50/60 Hz)
------------------------------------	----------------------

Power consumption	45 W
-------------------	------

Physical

Dimensions	482 x 225 x 89 mm (19 x 8.9 x 3.5")
------------	-------------------------------------

Weight	4.7 kg (10.4 lbs)
--------	-------------------

*) incl. all channel and bus processing, excl. insert effects and line delays

AES50 is created and owned by the Audio Engineering Society. ADAT is a registered trademark of inMusic Brands, Inc. Toslink is a registered trademark of Toshiba Corporation. Cirrus Logic is a trademark of Cirrus Logic, Inc.

FEDERAL COMMUNICATIONS COMMISSION COMPLIANCE INFORMATION



Responsible Party Name: **MUSIC Group Services US Inc.**
Address: **18912 North Creek Parkway,
Suite 200 Bothell, WA 98011,
USA**
Phone Number: **+1 425 672 0816**

DIGITAL SNAKE S16

complies with the FCC rules as mentioned in the following paragraph:

This equipment has been tested and found to comply with the limits for a Class B digital device, pursuant to part 15 of the FCC Rules. These limits are designed to provide reasonable protection against harmful interference in a residential installation. This equipment generates, uses and can radiate radio frequency energy and, if not installed and used in accordance with the instructions, may cause harmful interference to radio communications. However, there is no guarantee that interference will not occur in a particular installation. If this equipment does cause harmful interference to radio or television reception, which can be determined by turning the equipment off and on, the user is encouraged to try to correct the interference by one or more of the following measures:

- Reorient or relocate the receiving antenna.
- Increase the separation between the equipment and receiver.
- Connect the equipment into an outlet on a circuit different from that to which the receiver is connected.
- Consult the dealer or an experienced radio/TV technician for help.

This device complies with Part 15 of the FCC rules. Operation is subject to the following two conditions:

- (1) this device may not cause harmful interference, and
- (2) this device must accept any interference received, including interference that may cause undesired operation.

Important information:

Changes or modifications to the equipment not expressly approved by MUSIC Group can void the user's authority to use the equipment.



We Hear You