

# X32 RACK

40-Input, 25-Bus Digital Rack Mixer with 16 Programmable MIDAS Preamps, USB Audio Interface and iPad/iPhone\* Remote Control



- 40-input channel, 25-bus, 3U rack-mountable digital mixer for live and installed sound application
- 16 MIDAS-designed, fully programmable mic preamps for audiophile sound quality
- 8 XLR outputs plus 6 additional line in/outputs, a phones connector and a talkback section with XLR mic input
- 32 x 32 channel USB 2.0 audio interface
- iPad\* and iPhone\* apps for professional remote operation available free of charge—no host PC required
- High-resolution 5" day-viewable Color TFT for easy viewing of workflow components and parameters
- Main LCR, 6 matrix buses and all 16 mix buses each featuring inserts, 6-band parametric EQ's and full dynamics processing, plus 8 DCA and 6 mute groups
- Virtual FX rack featuring 8 true-stereo FX slots include high-end simulations such as Lexicon 480L\* and PCM70\*, EMT250\* and Quantec QRS\* etc.
- 40-Bit floating-point DSP features "unlimited" dynamic range with no internal overload and near-zero overall latency (0.8 msec)
- Powerful scene management for convenient handling of complex productions

Thanks to its legendary onboard X32 mix engine, the X32 RACK can be your top-notch studio recording interface today, control a complex theater production tomorrow, or sit securely in your side-rack while you mix your band's club gig from your iPad. A revolution in its own right, the incredible X32 RACK combines the finest analog I/O and powerful digital connectivity with ample processing for 40 channels, 25 buses and up to 152 signal sources.

You can easily control every parameter of the mix directly on the X32 RACK using the 800 x 480 graphic UI, but the awesome flexibility of networked remote control literally opens up an amazing world of possibilities. Use our X32-EDIT PC/Mac/Linux application, X32-MIX for iPad, X32-Q for iPhone/iPod touch and X32-Q for Android to control the mix from anywhere in the room. You can even run multiple instances of these powerful apps at the same time, giving your performers the ability to mix their own personal monitors on-the-fly!

With its 16 MIDAS-design mic preamps and dual AES50 ports, the X32 RACK can support up to six S16 digital stage boxes for massive I/O connectivity. Ultra-flexible routing options and 8 powerful stereo FX engines make the X32 RACK the ideal choice for handling audio now – and as your needs grow.



# X32 RACK

40-Input, 25-Bus Digital Rack Mixer with  
16 Programmable MIDAS Preamps,  
USB Audio Interface and iPad/iPhone\*  
Remote Control

- 48-channel Digital Snake ready\*\*\* via dual AES50 ports, featuring KLARK TEKNIK's SuperMAC networking capability for ultra-low jitter and latency
- USB type-A connector providing file storage and uncompressed stereo recordings plus show presets and system updates
- ULTRANET connectivity for BEHRINGER's P16 Personal Monitoring System\*\*\*
- Networked remote control via Ethernet for show setups with on-screen software editor
- Built-in expansion port for audio interface cards or digital networking bridges
- MIDI In/Out for remote scene recall or controlling other MIDI equipment
- Future firmware updates, incl. new FX "Plug Ins", downloadable from behringer.com free of charge
- 3-Year Warranty Program\*\*
- Conceived and designed by BEHRINGER Germany

## Game 2.0 Reloaded

The **BEHRINGER X32** has changed the game by completely rethinking what is possible from a digital mixer – and hundreds of thousands of users are enjoying the results. A fluid workflow coupled with a fully interactive user interface ensures immediate familiarity and instills confidence. Advanced engineering and meticulous design deliver stellar sonic performance at an extremely affordable price – changing the game entirely.

Three companies shared a common vision – to engineer and build the very best-sounding, technically-advanced audio products for discerning professionals. The **X32** Digital Mixer family is the result of the engineering, manufacturing and application expertise of legendary console manufacturer **MIDAS**, the iconic signal processing genius of **KLARK TEKNIK** and **BEHRINGER's** unique ability to deliver a superior value proposition.

The synergy between these three great companies runs deep in the **X32**. From the pristine, **MIDAS**-designed mic preamps to **KLARK TEKNIK's** rock-solid, ultra-low latency SuperMAC networking technology and **BEHRINGER's** completely re-engineered processing algorithms, **X32** raises the bar on what a digital mixer can be. A singular passion for delivering advanced technology, unrivalled usability and true road-worthiness has enabled us to engineer a digital console that is the ideal vehicle for your creative expression. But we're just getting started!

## Enhanced Workflow & Multi-Channel Networking

With the introduction of our new **X32** version 2.0 firmware, we have not only dramatically enhanced the workflow, but also added all-new capabilities including "Acoustic Integration" for total connectivity and control of your speaker and In-Ear Monitor (IEM) systems. Then we completely re-imagined the more than 50 onboard FX "Plug-Ins" and added classic processor examples based on "True Physical Modelling". We've also made the **X32** even more flexible, with swappable expansion cards for connecting to other multi-channel audio networking via USB, ADAT, MADI and Dante protocols, in addition to the onboard ULTRANET and AES50 connectivity. Above all, the **X32** puts the power of digital in your hands – without compromise.



You Win.

\*iPad and iPhone are trademarks of Apple Inc. All third-party trademarks are the property of their respective owners. Their use neither constitutes a claim of the trademark nor affiliation of the trademark owners with MUSIC Group. Product names are mentioned solely as a reference for compatibility, effects and/or components.

\*\*Warranty details can be found at music-group.com.

\*\*\*P16 Personal Monitoring System and Digital Snake are not included.

# X32 RACK

40-Input, 25-Bus Digital Rack Mixer with  
16 Programmable MIDAS Preamps,  
USB Audio Interface and iPad/iPhone\*  
Remote Control



## Intuitive. Immediate. Natural.

X32 RACK is your mind-to-sound interface... the intersection of creativity and production. Whether you're accustomed to digital mixers or not, the X32's intuitive user interface offers a fluid mixing experience that instantly feels like home.

And then there is the X32's latest version 2.0 firmware. We've added new scene management features and EQ functions, including a 100-band Real Time Analyzer, flexible library import/export capability and faster FX editing.

We also included 16 new FX "Plug-Ins" which are based on True Physical Modeling of famous classic audio hardware. This process means that we essentially "rebuilt" classic analog gear in the digital domain.

And then we added the most amazing digital networking that allows you to connect to the new [TURBOSOUND iQ](#) speakers via simple CAT5 connection. We call it "Acoustic Integration".

This high-performance iQ Series also includes authentic acoustic modeling of some of the world's most famous speakers – all remote controllable from your X32 RACK.

This is the total solution you have been waiting for.

## Front Side Control

A set of front panel controls are provided on the X32 RACK, enabling the engineer to make adjustments to the live mix without any additional hardware. The rear panel expansion port allows inserting optional I/O cards to interface with existing networked audio infrastructure.



# X32 RACK

40-Input, 25-Bus Digital Rack Mixer with  
16 Programmable MIDAS Preamps,  
USB Audio Interface and iPad/iPhone\*  
Remote Control



## At the Heart of it All

The X32 RACK forms the nucleus of an ultra-flexible studio control room setup when paired with S16 I/O and P16 Personal Monitoring Systems in each tracking room. The built-in 32 x 32 USB recording interface, 8 stereo effects engines, zero-latency monitoring (independent from DAW) and 100% total recall deliver the tools to handle any project you dare to tackle.

## 5" Main Display

X32 RACK's 5" day-viewable color TFT (Thin-Film Transistor) display shows the setting parameters you need when you need them.

Selected for its high-contrast performance and outdoor visibility, TFT is ideal for concert and open air festival venues. Flanked by high-precision, context-sensitive tactile encoders, the screen comes to life and immediately reports in high definition all adjustments applied to a wide range of parameters.

Intelligent design puts control of vital functions such as Effects, Metering, Routing and much more 1 or 2 button presses away.



# X32 RACK

40-Input, 25-Bus Digital Rack Mixer with  
 16 Programmable MIDAS Preamps,  
 USB Audio Interface and iPad/iPhone\*  
 Remote Control

## “Acoustic Integration” – the Live Sound Revolution

Legendary 40-year old British company **TURBOSOUND**, famous for producing some of the world’s best speaker systems, have teamed up with **BEHRINGER** to seamlessly integrate mixer and speaker systems. We call it “Acoustic Integration”.

The X32 RACK’s ULTRANET bus allows streaming up to 16-channels of pristine digital audio to an array of **TURBOSOUND** iQ speakers - all on a single CAT5 cable, along with control data to set sound presets remotely.

Furthermore, the iQ Series features “True Physical Modeling” of some of the most popular speakers which can be easily remote controlled via the X32 RACK, allowing the sound engineer to apply different speaker models in real time from the comfort of the mixing desk.

“Acoustic Integration” is the next live sound revolution.

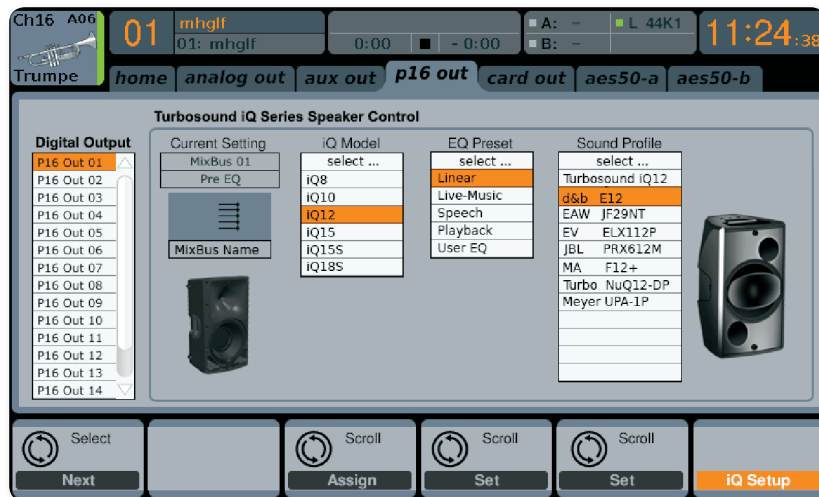

# X32 RACK

40-Input, 25-Bus Digital Rack Mixer with  
16 Programmable MIDAS Preamps,  
USB Audio Interface and iPad/iPhone\*  
Remote Control

## 100-Band RTA for all Channel/Bus EQ's

The X32 RACK now includes a high-resolution 100-band Real Time Analyzer (RTA), with full Bar and Spectrograph views. This high-resolution RTA displays the audio energy distribution in 100 frequency bands over time – capturing a sonogram window of a full 10 seconds.

Switch between the Large RTA view, displaying any available signal in full screen resolution, or the Combined view with the RTA view shown above each of the channel and bus EQ curves.

See the results of your filtering choices in the audio spectrum directly. Additionally, the RTA can be displayed on top of the 31-band graphic EQs in the FX rack.

Monitoring and controlling frequencies has never been easier!



# X32 RACK

40-Input, 25-Bus Digital Rack Mixer with  
16 Programmable MIDAS Preamps,  
USB Audio Interface and iPad/iPhone\*  
Remote Control

## 16 Breathtaking FX “Plug-Ins” Based on True Physical Modeling

We’ve added 16 new FX “Plug-Ins” to the X32 RACK, giving you access to a total of 50+ effects that would otherwise cost tens of thousands of dollars in hardware.

This new generation of high-end FX “Plug-Ins” is based on True Physical Modeling of classic audio hardware. We essentially “rebuilt” classic analog gear in the digital domain and included models of legendary processors such as Urei’s 1176\*, Teletronix LA-2A\* and Fairchild 670\* compressors as well as the legendary Pultec\* EQP-1a and EQ5 equalizers etc. We also added a cutting-edge 5-band multiband compressor.

Last but not least, the X32 RACK can now run 4 studio-quality stereo reverbs together with 8 channels of 31-band graphic EQ. This allows you to replace your old outboard gear with a fully recallable onboard solution.



# X32 RACK

40-Input, 25-Bus Digital Rack Mixer with  
16 Programmable MIDAS Preamps,  
USB Audio Interface and iPad/iPhone\*  
Remote Control

## Gain Splitting and Remote Control for FOH and Monitoring

A new Gain Split mode separates channel gain (trim) from the head amp gain, allowing both the FOH and/or the monitor engineer to adjust local trim digitally – and independently of the preamp gain.

Additionally, the new HA Gain Remote option allows console gains to be remotely controlled by an external console, such as when using the X32 RACK as a stage box.





# X32 RACK

40-Input, 25-Bus Digital Rack Mixer with  
 16 Programmable MIDAS Preamps,  
 USB Audio Interface and iPad/iPhone\*  
 Remote Control

## More Routing and Processing Flexibility

The X32 RACK's routing becomes even more flexible with this recent firmware upgrade. Output signals and XLR outputs are now treated separately, allowing signals from AES50 sources or expansion cards to be routed directly to the X32 RACK's analog outputs.

For example, now you can use the outputs from an X32 RACK for directly routing back PA or monitoring signals from a main or FOH console. New output tap points can be set as pre- or post-mute for greater usability with your P16 personal monitoring mixers. This is very useful in situations where you don't want mute groups to interrupt your signal flow.



# X32 RACK

40-Input, 25-Bus Digital Rack Mixer with  
16 Programmable MIDAS Preamps,  
USB Audio Interface and iPad/iPhone\*  
Remote Control

## Mighty New Tools for Scene and Show Management

Introducing the Cue List, an innovative way to automate the loading of scenes and new “Snippets” at different points during a show. Each of the 500 Cue entries can load any of the 100 Scenes or Snippets separately or at the same time. This gives you an amazing total of 500 Cues x 100 Scenes x 100 Snippets!

For example, store your favorite EQ settings for drums on channels 1-8 as a Snippet, recallable in an instant as its own preset, completely independent of the console’s overall scene. It’s like taking a snapshot of a parameter on an input, return, FX slot, bus, Matrix, Main or DCA group – and saving it for quick access whenever you need it.



# X32 RACK

40-Input, 25-Bus Digital Rack Mixer with  
16 Programmable MIDAS Preamps,  
USB Audio Interface and iPad/iPhone\*  
Remote Control



## MIDAS The Golden Preamp

X32 RACK's input topology – mic preamps, programmable gain controls and A/D stages were designed by a dedicated engineering team at **MIDAS**, the company famous for their award-winning mic preamplifier designs.

Conceived as a single, cohesive system, and built around premium A/D converters, this proprietary preamp design captures every nuance of your input signal – ensuring superb sonic performance.

Gain setting is fully programmable and covers a total range of 72 dB, with a precision resolution of 0.5 dB per step.

Accommodating a maximum input signal level of +23 dBu, X32 RACK turns analog VRs and pad switches into ancient history.

Backing the analog input section are audiophile-quality Cirrus Logic multi-channel A/D converters, which boast a 114 dB dynamic range, ensuring impressively-low distortion and low-noise performance.

The **MIDAS** designed preamplifier ensures signal integrity of the highest degree.

## Audio Networking & Interfacing

X32 RACK includes an array of control and networking capabilities as standard features. Dual-port AES50 digital networking supports up to 96 channels of audio over shielded (STP) CAT5 cable, allowing remote stage boxes and sharing signals among several connected X32 RACKs. Onboard ULTRANET provides a 16-channel digital mix direct to P16 Personal Monitor Mixers, without added hardware, cost or latency. Ethernet, USB 2.0, MIDI – all standard features on the X32 RACK.

## Powerplay P16

Personal Monitoring System

Easy as a handshake. Plug the **P16-M** personal monitor mixer into X32 RACK's ULTRANET port with a shielded (STP) CAT5 cable, and let the performer dial in their ideal 16-channel personal monitor mix. You can daisy-chain additional **P16-M** units, or use the **P16-D** ULTRANET distributor to set up a plug and play monitor system that directly supplies up to 8 individual **P16-M** units with power and audio. Cascading additional **P16-D** hubs can expand the system to provide 16-channel feeds to literally hundreds of personal mixers.



# X32 RACK

40-Input, 25-Bus Digital Rack Mixer with  
16 Programmable MIDAS Preamps,  
USB Audio Interface and iPad/iPhone\*  
Remote Control



## POWERPLAY P1

Personal In-Ear Monitor Amplifier

The **POWERPLAY P1** Personal In-Ear Monitor (IEM) Amplifier puts control where it's most useful – right at the artist's fingertips. Use a **P16-M** for creating your personal mix to then feed it to your P1 beltpack. Whether on stage or in the studio, the P1 provides performers and recording artists with a dependable and affordable personal monitoring solution.

## S16

Leave That Heavy Analog Snake Behind

The **S16** digital stage box closes the gap between stage and FOH (Front of House) by placing 16 fully-programmable, remotely controllable **MIDAS** Mic Preamps and 8 analog, balanced XLR returns at the stage end. Connecting over a single shielded (STP) CAT5 cable, up to three **S16** stage boxes can be daisy-chained to deliver 48 channels in and 24 out to the stage. Dual AES50 ports on the **X32 RACK** allow up to 96 input channels to be connected and routed in the same system.

- AES50 network ports featuring **KLARK TEKNIK** SuperMAC technology for ultra-low latency (in-ear compatible)
- Remote operation via shielded CAT5e cable up to 330 ft / 100 m length
- Dual AES50 ports, each for cascading up to three S16 units – no merger or router required
- Precise LED metering plus 7-segment displays for signal control on stage
- Phones output assignable to any of the inputs/outputs for on-stage monitoring
- Connectivity for **BEHRINGER's P16** Personal Monitoring System for in-ear applications
- Dual ADAT outputs for use in splitter mode and stand-alone digital multi-core applications
- MIDI in/out for bi-directional communication between FOH console and on-stage MIDI devices



# X32 RACK

40-Input, 25-Bus Digital Rack Mixer with  
16 Programmable MIDAS Preamps,  
USB Audio Interface and iPad/iPhone\*  
Remote Control



In addition to the [S16](#), a wide range of remote I/O options are available for the X32 RACK, such as the [S32](#), [SD16](#) and [SD8](#) digital stage boxes – all of which feature the same high-end [MIDAS](#) Mic Preamps. For more information, please visit their respective web pages.

## What are AES50 and SuperMac?

AES50 simultaneously provides high channel counts, extremely low and deterministic latencies, accurate phase-aligned networked clock distribution, error detection, network redundancy, with simple deployment and ease of use to meet the needs of the live performance industry.

This unique combination also benefits both live and studio recording applications, as well as post-production, broadcasting and audio routing infrastructure. SuperMAC is a proprietary implementation of AES50 owned by [KLARK TEKNIK](#). Originally developed by Sony Pro-Audio Labs in Oxford, UK, it forms the basis of the Audio Engineering Society's AES50 open standard for digital audio networking – High Resolution Multi-channel Audio Interconnection (HRMAI), as published by the Audio Engineering Society, Inc.

- 48 bidirectional audio channels @ 48 kHz over Neutrik etherCON-terminated cable
- Remote operation via shielded CAT5e cable up to 330 ft / 100 m length
- Single cable duplex interconnection for audio and sample clocks
- Ethernet physical layer audio data transmission
- High channel count and ultra-low deterministic latency ( $2 \times 3$  samples =  $\frac{1}{8}$  ms per node)
- Accurate phase-aligned clock distribution
- Comprehensive error detection and management
- Provision for redundant networking
- Minimal configuration – total ease of deployment and use
- Ethernet TCP/IP protocol-compatible auxiliary data channel



# X32 RACK

40-Input, 25-Bus Digital Rack Mixer with  
16 Programmable MIDAS Preamps,  
USB Audio Interface and iPad/iPhone\*  
Remote Control



## Expandability

Each X32 RACK comes loaded with all of the connectivity, I/O and functionality you need, right out of the box – but it does not end there.

Onboard USB 2.0 connectivity delivers a full 32 x 32 channels of audio and MIDI to your DAW. Integrated multi-channel digital audio interfaces connect to remote stage boxes and/or the P16 Personal Monitor System.

Native Ethernet control enables remote operation by computer, iPad or iPhone over a wired or wireless network, across the room – or across the planet!

Keeping all this power up-to-date is easy; just navigate to [behringer.com](http://behringer.com) for the latest enhancements, additions and features.

Download new firmware onto a USB flash drive and insert it into the X32 RACK; then re-boot and start enjoying an endless array of new functionality and performance.

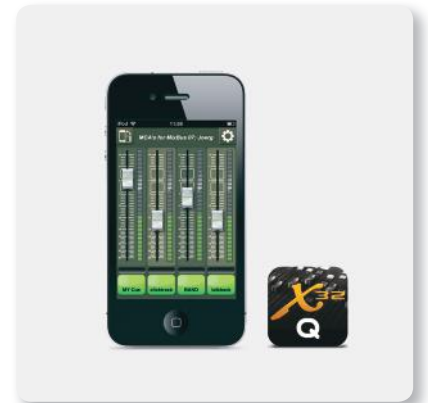

# X32 RACK

40-Input, 25-Bus Digital Rack Mixer with  
16 Programmable MIDAS Preamps,  
USB Audio Interface and iPad/iPhone\*  
Remote Control

## The FX Racks

X32 RACK includes an extensive array of onboard effects, rendering outboard processing racks a thing of the past. The Virtual FX rack features 8 true-stereo, studio-grade effects engines each assignable to any input, group or output mix bus. Choose from high-end FX modules including a range of reverbs, delays, EQs, dynamics and much more.

Each FX algorithm has been completely re-imagined for stunning performance – typically costing several times the price of the X32 RACK.

Custom-designed, and physically modeled after some of the most iconic and sought-after processors, all effects run inside the low-latency environment of the X32 RACK mix engine, ensuring flawless performance, flexible routing and the end of cable faults forever!

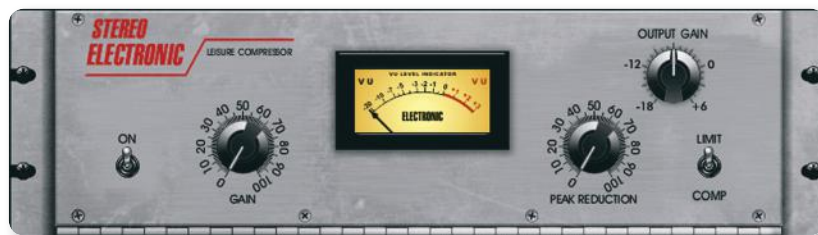

The immaculate tube signal path in Teletronix' LA-2A Leveling Amplifier has left its exceptional clarity, its rich and warm compression on countless albums of the past decades.

The ultra-smooth optical attenuator is closely modeled in our **LA COMPRESSOR**. It provides breezing, natural and effortlessly musical compression. (Inspired by Teletronix LA-2A\*)



When Urei released the 1176LN Limiting Amplifier in the late 60's, it broke new ground. Field Effect Transistors employed were just invented and the 1176 was one of the first audio processors to benefit from this new technology.

Our digital re-incarnation, **ULTIMO COMPRESSOR**, is based on the early Rev. E model and authentically captures the smooth character of the original class-A output stage and its FET's legendary fast Attack. (Inspired by Urei 1176LN\*)

# X32 RACK

40-Input, 25-Bus Digital Rack Mixer with  
 16 Programmable MIDAS Preamps,  
 USB Audio Interface and iPad/iPhone\*  
 Remote Control



The Fairchild 670 tube compressor not only achieves record bids in high-end vintage gear auctions, it also delivers some of the finest colorations in compressor history. Two small trim VR's preset the control side chain action, a six-step switch determines the timing, and the two large Input and Threshold knobs adjust the levels. Our **FAIR COMPRESSOR** model is true to the original signal path, and conveniently provides models for dual, stereo-linked or M/S operation. (Inspired by Fairchild 670\*)



The **COMBINATOR** is an amazing 5-band compressor that emulates famous broadcasting and mastering compressors.

A highly complex processor, the **COMBINATOR** utilizes automatic parameter control that produces stunning and “inaudible” results. Makeup-gain for each frequency band will automatically be adjusted by the Spectral Balance Control (SBC) function, to maintain a balanced audio spectrum.



# X32 RACK

40-Input, 25-Bus Digital Rack Mixer with  
16 Programmable MIDAS Preamps,  
USB Audio Interface and iPad/iPhone\*  
Remote Control



The XTEC EQ1 is undisputedly one of the best passive studio equalizers ever manufactured. Virtually indescribable, recording engineers claim the Pultec EQP-1a to be the “secret sauce” of sound enhancement.

We analyzed this classic to the core and created an exact physical model that reproduces the multi-faceted sound in painstaking detail. Even the transformers and tube output stage have been faithfully modeled! (Inspired by Pultec EQP-1a\*)



Pultec simply wrote the book on passive equalization. By digitally “rebuilding” every aspect of the original Pultec classic, we captured the very essence in our parametric equalizer XTEC EQ5. Our digital re-incarnation is based on the original model and authentically emulates the smooth character of the its rather unique components. (Inspired by Pultec MEQ5\*)

# X32 RACK

40-Input, 25-Bus Digital Rack Mixer with  
16 Programmable MIDAS Preamps,  
USB Audio Interface and iPad/iPhone\*  
Remote Control



The new **SUB OCTAVER** provides two channels of earth-shattering sub-harmonics generation, one or even two octaves below the input signal. While originally designed for bass players, the effect can be adjusted for Hi, Mid and Low frequency tracking to apply to a wide range of applications. This is your secret weapon for beatboxing...



The **EDISON EX1** is the re-incarnation of our own analog classics. This remarkably-effective tool allows manipulation of the stereo field. Selectable M/S input/output modes allow the processing or creation of M/S recorded sound sources. (Inspired by [BEHRINGER EDISON](#))



The **SOUND MAXIMIZER** restores natural brilliance and clarity to any audio signal by adjusting the phase and amplitude integrity to reveal more of the natural texture of the sound, which is often hidden when using some effects and equalizers. (Inspired by Sonic Maximizer 482i\*)

# X32 RACK

40-Input, 25-Bus Digital Rack Mixer with  
16 Programmable MIDAS Preamps,  
USB Audio Interface and iPad/iPhone\*  
Remote Control



The **DIMENSIONAL CHORUS** is the perfect emulation of what has been referred to as “the best analog Chorus unit ever created”. Four simple Mode preset buttons activate amazing effects, best described as “space” and “dimension”. Absolutely faithful to the original, multiple preset buttons can be pressed simultaneously. (Inspired by Roland Dimension D Chorus\*)



**MODULATION DELAY** combines three of the most used time modulation effects into one easy-to-operate unit. Enjoy true-stereo delay with a lush and spacious chorus, topped off with three reverb models to choose from.

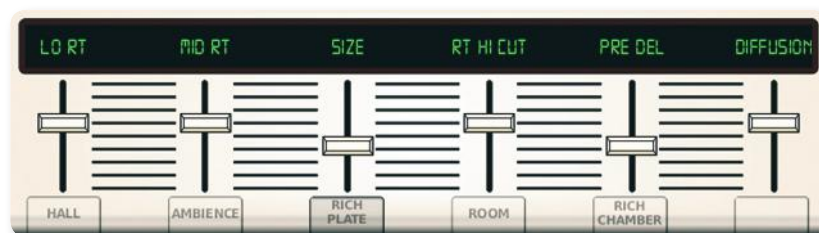

The Lexicon 480L\* has been recognized as the gold standard of digital reverb. We have included three of the finest reverb models - Rich Plate, Room and Rich Chamber. The X32 RACK's models precisely capture all nuances based on our “True Physical Modeling” and our algorithms even incorporate the unit's AD/DA gain stepping converters — nailing the entire analog and digital circuit paths right down to the last detail. (Inspired by Lexicon 480L\*)

**EXCITERS** increase presence and intelligibility in live sound applications and are indispensable for adding clarity, air and harmonic overtones in the recording studio. **ENHANCERS** let you emphasize the Bass, Midrange and Hi output at selectable frequencies. You can generate maximum punch, clarity and detail, without turning up the overall volume. (Inspired by Aphex Aural Exciter\* and SPL Vitalizer\*)

# X32 RACK

40-Input, 25-Bus Digital Rack Mixer with  
16 Programmable MIDAS Preamps,  
USB Audio Interface and iPad/iPhone\*  
Remote Control



Our **TruEQ STEREO GEQ** delivers musical and responsive signal processing—perfect for general room equalization, indispensable for monitoring. X32 RACK provides up to 16 mono graphic EQs, in addition to the multi-band parametric EQs in all channels and buses, to cope with the most demanding stage monitoring situation.

Plus, the X32 RACK's motorized faders can be switched to control the filter bands of the graphic EQ, with the channel LCDs showing the corresponding filter frequencies—and you can even put this on a user defined hot-key for immediate access. (Modeled after **KLARKTEKNIK DN360**)



**VINTAGE ROOM** stands out head and shoulders over other competing reverberation strategies in the way it models sound propagation in air and room resonances. Invented in the early '80s, the role model delivered authentic room character from an algorithmic reverb long before convolution-based processing was available. It is an ideal reverb for mixes or sub-groups, as it adds space to complex signals—highly valued in classical music and broadcasting environments. (Inspired by Quantec QRS\*)

# X32 RACK

40-Input, 25-Bus Digital Rack Mixer with  
 16 Programmable MIDAS Preamps,  
 USB Audio Interface and iPad/iPhone\*  
 Remote Control

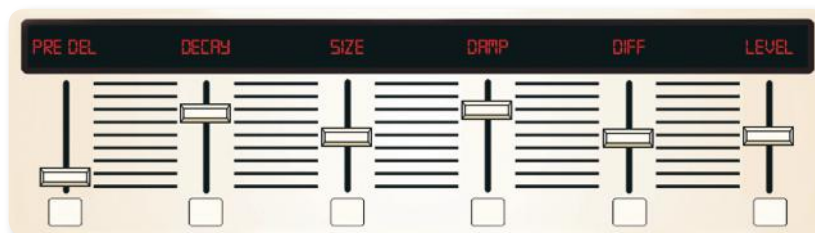

**PLATE REVERB** emulates the characteristics of a plate reverb chamber with control over the damping pad, modulation depth and speed, and crossover. PLATE REVERB will give your tracks the sound heard on countless hit records since the late 1950's. (Inspired by Lexicon PCM70\*)



The **3-TAP DELAY** in the X32 RACK records the input signal and then echoes it back after a user-definable period of time and number of repeats. What makes the stereo and triple delay useful and outstanding is the linked tap-timing and musical choice of echo patterns.

Use the 3-TAP DELAY to fatten up vocals and instruments, or to add an enhanced spatial element to any performance.



The **HALL REVERB** effect provides a broad spectrum of reverberation possibilities, from small room to large, or even cavernous proportions. When softly mixed with the original signal, Hall Reverb can be used to create a warm, more natural sound. (Inspired by Lexicon 480L\*)

# X32 RACK

40-Input, 25-Bus Digital Rack Mixer with  
16 Programmable MIDAS Preamps,  
USB Audio Interface and iPad/iPhone\*  
Remote Control



This handy dynamic **FLANGER & DELAY** duo blends the “whoosh” of soaring jet planes with classic Delay, and can be adjusted from mild to wild. This combination effect only takes up one FX slot. (Inspired by Lexicon PCM70\*)



**WAVE DESIGNER** is a powerful tool for adjusting signal transients and dynamics such as attack and sustain. Use it to make a snare drum really “crack” in the mix or level out volume inconsistencies of slap bass tracks. (Inspired by SPL Transient Designer\*)

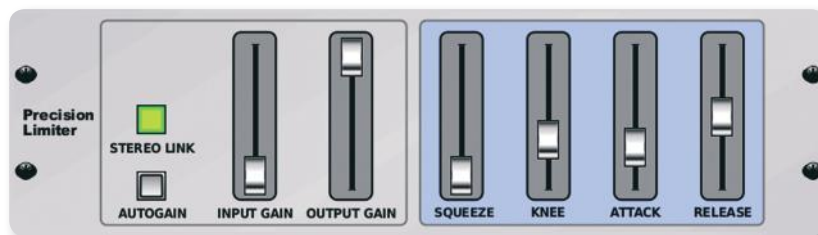

The **STEREO PRECISION LIMITER** is perfect for setting a precise volume limits, ensuring distortion-free and optimal signal integrity. Use the Stereo Precision Limiter to boost quiet signals or reduce the level of “hot” signals to prevent clipping. (Inspired by Sony Oxford Dynamics\*)

Digital Mixers

# X32 RACK

40-Input, 25-Bus Digital Rack Mixer with  
 16 Programmable MIDAS Preamps,  
 USB Audio Interface and iPad/iPhone\*  
 Remote Control



The **DE-ESSER** is a “must-have” tool for reducing the amount of sibilance in vocal mics while adeptly preserving the natural voice timbre of a performance. Use it to enhance the smoothness of the upper mid to high frequencies in vocals as well as drum overheads and strings, etc. (Inspired by SPL 1239\*)



Based on the legendary EMT250, the **VINTAGE REVERB** delivers a shimmering, bright reverb that won’t drown out or overpower your live/recorded tracks. Use the VINTAGE REVERB to sweeten vocals and snare drums without sacrificing clarity. (Inspired by EMT250 Plate Reverb\*)



Taking up only one FX slot, the **CHORUS & CHAMBER** effect combines the shimmer and doubling characteristics of a studio-grade Chorus with the sweet sound of a traditional Chamber reverb. (Inspired by Lexicon PCM70\*)

# X32 RACK

40-Input, 25-Bus Digital Rack Mixer with  
16 Programmable MIDAS Preamps,  
USB Audio Interface and iPad/iPhone\*  
Remote Control



## X-USB

A versatile powerhouse of a live console, the X32 RACK also provides robust studio functionality. Record and play back up to 32 tracks, which run on Windows XP, Windows Vista, Windows 7, and Windows 8 operating systems or Mac computers via USB 2.0 connectivity. X32 RACK supports 44.1 and 48 kHz sample rates at 24-Bit, allowing you to record up to 32 tracks of live audio directly to your computer for mixing down later. Take advantage of X32 RACK's built-in FX engines to augment your DAW's plug-in collection, or to free up valuable computer resources. X32 RACK's recall capability makes it easy for both project and professional studio engineers to stay organized by storing projects as scenes, either internally or externally on a USB stick.

## Optional Expansion Cards

The X32 RACK's expansion slot provides flexible and expandable connectivity for many different applications. A wide array of X-Expansion Cards can easily be used in place of the pre-installed X-USB card to release the power of X32 RACK into existing MAD1\*, Dante\* and ADAT networks. Fully compatible with these widely available audio protocols, the X32 RACK delivers a seamless integration in digital live sound, recording and broadcast environments.

## X-UF

### Hi-Speed FireWire/USB 2.0 Audio Interface for Professional Recordings

The X-UF Expansion Card ensures a stable and fast solution for professional live and studio recordings. It provides 400 Mbit/second throughput to transfer your high-track count session to popular Software DAWs on Mac and PC via FireWire or USB 2.0. Additionally, the X-UF turns your X32 RACK into a sophisticated control surface, and includes remote HUI\* and Mackie Control\* emulation.





# X32 RACK

40-Input, 25-Bus Digital Rack Mixer with  
16 Programmable MIDAS Preamps,  
USB Audio Interface and iPad/iPhone\*  
Remote Control



## X-ADAT

### High-Performance 32-Channel ADAT Expansion Card for X32

The **X-ADAT** Expansion Card allows you to digitally integrate your X32 RACK with any equipment featuring ADAT I/O. This includes stand-alone recorders, digital audio workstations, and other digital mixers and signal processing gear. The **X-ADAT** card provides 32-channels of ADAT inputs and outputs on its 8 fiber-optic Toslink\* connectors. The card features 24-bit signal transmission and operates at both 44.1 and 48 kHz sample rates, maintaining your signal integrity. The **X-ADAT** card also has a BNC word-clock in/out capability allowing it to sync with an external clock, or provide the clock signal for other devices. External clock synchronization is possible through the BNC connection, as well as any of the 4 Toslink ports.

## X-MADI

### High-Performance 32-Channel MADI Expansion Card for X32

The **X-MADI** Expansion Card brings even more I/O options to the X32 RACK by instantly enabling it for MADI networking. The MADI or AES10 protocol is quickly becoming an industry standard in many broadcast applications. **X-MADI** provides optical duplex SC-plugs (IEC874-19) to connect with fiber-optic MADI devices, with multimode fiber-optic cable lengths of up to 2 km supported. Dual BNC terminals are also provided for transmission via standard 75-Ohm coaxial cable of up to 100 m length. The BNC and fibre optic connectivity can also be used simultaneously, creating a reliable redundancy network with fiber-optic installations. **X-MADI** card is the perfect solution for integrating the X32 RACK into current installations using the MADI protocol.



## X-DANTE

### High-Performance 32-Channel Audinate Dante Expansion Card for X32

By installing the **X-DANTE** card in place of the **X-USB** card, your X32 RACK will interface with Dante networks using virtually any 100Mbit/s or Gigabit Network infrastructure with DSCP-based QoS – providing dependable multi-channel audio that coexist with other IP-based data traffic on the same network. The **X-DANTE** card utilizes 24-bit signal transmission with sample-accurate synchronization and low latency, ensuring the highest audio integrity. And a secondary input allows you to set up a seamless, redundant network. Full remote control of the X32 RACK is possible using the integrated Ethernet switch. When the **X-DANTE** card is connected to a computer, Audinate's Dante Controller application gives you full control over configuration and signal routing among your Dante-enabled devices.



# X32 RACK

40-Input, 25-Bus Digital Rack Mixer with  
16 Programmable MIDAS Preamps,  
USB Audio Interface and iPad/iPhone\*  
Remote Control

## X32-Edit (PC, Mac, Linux)

Simply connect the X32 RACK to a laptop or desktop PC or Mac Computer via LAN, wireless network or Ethernet cable. The X32-Edit app gives you command of the X32 RACK remotely via computer. Move a virtual fader on the PC, it moves on the X32 RACK; press a button on the computer, the button toggles on the X32 RACK. You'll find this feature extremely helpful for stage-side monitor control, individual control of multiple installed X32 family products, as well as multiple remote control stations of the same X32 RACK. The X32-Edit app also lets you create scenes on your PC beforehand to minimize the time required for sound checks.



## X32-Mix for iPad

Front of House is wherever you and your iPad are – thanks to the new X32-Mix for iPad. Just plug in a wireless router via Ethernet cable to the X32, and then wirelessly connect up to 10 iPad devices, which is especially handy for custom monitor mixes. The X32-Mix for iPad lets you control all mic inputs, AUX inputs and buses – plus the FX stereo returns and the Matrix, Main, and DCA levels. Select a fader bank on the iPad, slide the virtual faders and X32 RACK's virtual faders instantly mirror your action. Download the free X32-Mix for iPad from the App Store.

## X32-Q for iPhone & iPod touch

X32-Q is the perfect tool for setting up your personal monitoring mix with the X32 RACK. Compatible with iPhone models and iPod touch devices, each artist can run their own X32-Q for iPhone and iPod touch to adjust and tweak their personal wedge's mix. X32-Q includes an assignable MCA (Mix Control Association) feature that makes monitor mixing simple enough to be adjusted during performance. Assign any input or combination of inputs to one of the 4 MCA controls inside X32-Q and instantly get "more me", "less band", "more click track"... with a single sweep of your finger.

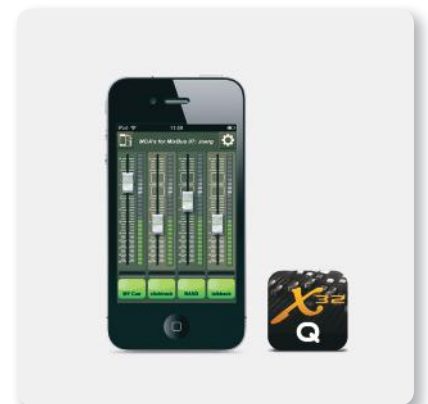

# X32 RACK

40-Input, 25-Bus Digital Rack Mixer with  
16 Programmable MIDAS Preamps,  
USB Audio Interface and iPad/iPhone\*  
Remote Control



## X32-Q (Android)

X32-Q is also available for Android devices (min 2.2), allowing you to set up your personal monitoring mix with the **BEHRINGER** X32 RACK. Compatible with Android mobile devices, each artist can run his own X32-Q Android app to adjust and tweak his personal IEM or wedge monitor mix with an interface similar to the iPhone app. The app includes an assignable MCA (Mix Control Association) feature for monitor mixing simple enough to be adjusted during performance. Assign any combination of inputs to one of the 4 MCA controls inside X32-Q Android and instantly get "more me," "less band," "more click track..."; with a single sweep of your finger.

## Compose. Record. Mix. Share.

Tracktion is one of the world's fastest and easiest Digital Audio Workstations (DAW) for composing, recording, editing, mixing and sharing your music with the world. Featuring a single-screen interface, and pushing the envelope in design elegance, Tracktion brings together outstanding Pro DAW features, such as dynamic automation, unlimited track count, MIDI recording and support for VST and AU plug-ins. This powerful music production software gives you all the tools of an entire professional-grade recording studio. Learning a DAW has never been easier, thanks to their vast and readily available library of resources.

As our way of saying "Thank You", when you register your X32 RACK at [behringer.com](http://behringer.com), we'll reward you with a complimentary download code for the full version of Tracktion. Recording and editing couldn't be easier.

To learn more about Tracktion, visit [tracktion.com/support/videos](http://tracktion.com/support/videos).

Share the Love. Visit [tracktion.com](http://tracktion.com) for more.



## Digital Mixers

# X32 RACK

40-Input, 25-Bus Digital Rack Mixer with  
16 Programmable MIDAS Preamps,  
USB Audio Interface and iPad/iPhone\*  
Remote Control



For service, support or more information contact the BEHRINGER location nearest you:

**Europe**  
**MUSIC Group Services UK**  
Tel: +44 156 273 2290  
Email: CARE@music-group.com

**USA/Canada**  
**MUSIC Group Services NV Inc.**  
Tel: +1 702 800 8290  
Email: CARE@music-group.com

**Japan**  
**MUSIC Group Services JP K.K.**  
Tel.: +81 3 6231 0454  
Email: CARE@music-group.com

MUSIC Group accepts no liability for any loss which may be suffered by any person who relies either wholly or in part upon any description, photograph, or statement contained herein. Technical specifications, appearances and other information are subject to change without notice. All trademarks are the property of their respective owners. MIDAS, KLARK TEKNIK, TURBOSOUND, BEHRINGER, BUGERA and DDA are trademarks or registered trademarks of MUSIC Group IP Ltd. © MUSIC Group IP Ltd. 2015 All rights reserved.



## Digital Mixers

# X32 RACK

POWERED BY MIDAS

### 40-Input, 25-Bus Digital Rack Mixer with 16 Programmable MIDAS Preamps, FireWire\*/USB Audio Interface and iPad/iPhone\* Remote Control

- 40-input channel, 25-bus, 3U rack-mountable digital mixer for live and installed sound application
- 16 MIDAS-designed, fully programmable mic preamps for audiophile sound quality
- 8 XLR outputs plus 6 additional line in/outputs, 2 phones connectors and a talkback section with XLR mic input
- 32 x 32 channel USB 2.0 audio interface
- iPad\* and iPhone\* apps for professional remote operation available free of charge—no host PC required
- High-resolution 5" day-viewable Color TFT for easy viewing of workflow components and parameters
- Main LCR, 6 matrix buses and all 16 mix buses each featuring inserts, 6-band parametric EQ's and full dynamics processing, plus 8 DCA and 6 mute groups
- Virtual FX rack featuring 8 true-stereo FX slots include high-end simulations such as Lexicon 480L\* and PCM70\*, EMT250\* and Quantec QRS\* etc.
- 40-Bit floating-point DSP features "unlimited" dynamic range with no internal overload and near-zero overall latency (0.8 msec)
- Powerful scene management for convenient handling of complex productions
- 48-channel Digital Snake ready\*\* via dual AES50 ports, featuring KLARK TEKNIK's SuperMAC networking capability for ultra-low jitter and latency



40-Input Channel, 25-Bus Digital Rack Mixer with 16 Programmable MIDAS Preamps, FireWire\*/USB Audio Interface and iPad/iPhone\* Remote Control

It can be your top-notch studio recording interface today, control a complex theatre production tomorrow, or sit securely in your side-rack while you're mixing your band's club gig from your iPad. The X32 RACK is a revolutionary new product genre that combines finest analog I/O and powerful digital connectivity, with ample processing for 40 channels, 25 buses and up to 152 signal sources.

While every parameter of your mix can be adjusted directly on the X32 RACK through its 800 x 480 graphic UI, networked remote control literally makes room for new possibilities. Several instances of our XControl PC/Mac application, XiControl app for iPad/iPad mini and XiQ app for iPhone/iPod touch allow controlling the mix from exactly the place you find most suitable.

16 MIDAS-design mic preamps provide plenty of inputs—and with its dual AES50 ports, X32 RACK can support up to six S16 digital snakes for massive I/O connectivity.

8 powerful stereo FX engines coupled with ultra-flexible routing options make the X32 RACK the ideal choice for handling audio now—and as your needs grow.





- USB type-A connector providing file storage and uncompressed stereo recordings plus show presets and system updates
- ULTRANET connectivity for BEHRINGER's P16 Personal Monitoring System\*\*
- Networked remote control via Ethernet for show setups with on-screen software editor
- Built-in expansion port for audio interface cards or digital networking bridges
- MIDI In/Out for remote scene recall or controlling other MIDI equipment
- Future firmware updates, incl. new FX "Plug Ins", downloadable from behringer.com free of charge
- Conceived and designed by BEHRINGER Germany

### Front Panel Controls

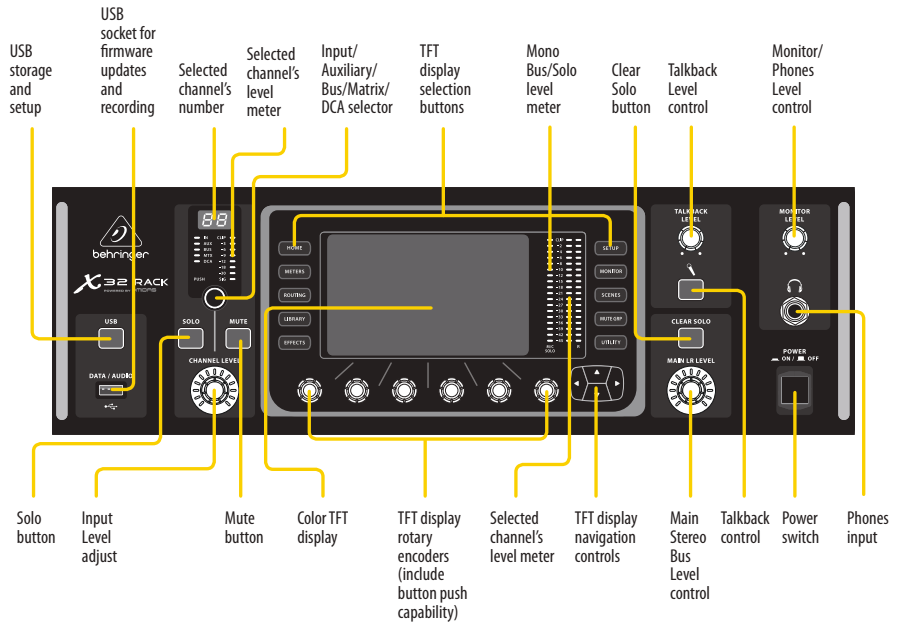

### Rear Panel Input/Output Patchbay

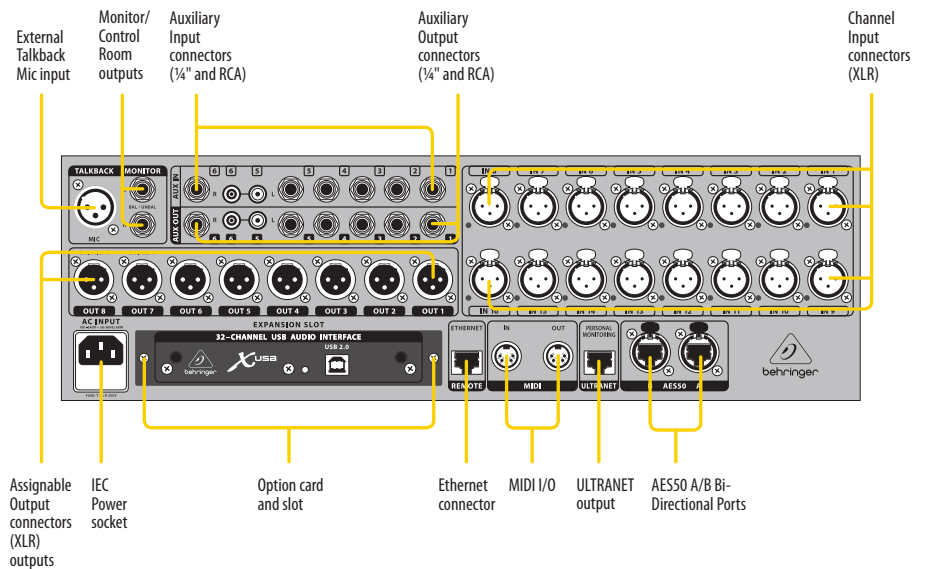

\*iPad and iPhone are trademarks of Apple Inc. All third-party trademarks including but not limited to Lexicon, PCM, EMT, Quantec and QRS are trademarks or registered trademarks of their respective owners. Their use neither constitutes a claim of the trademarks by MUSIC Group nor affiliation of the trademark owners with MUSIC Group. Product names are mentioned solely as a reference for X32 RACK compatibility and effects.

\*\*P16 Personal Monitoring System and Digital Snake are not included.



### X32 RACK Live Performance Setup with S16 and P16 Monitor System

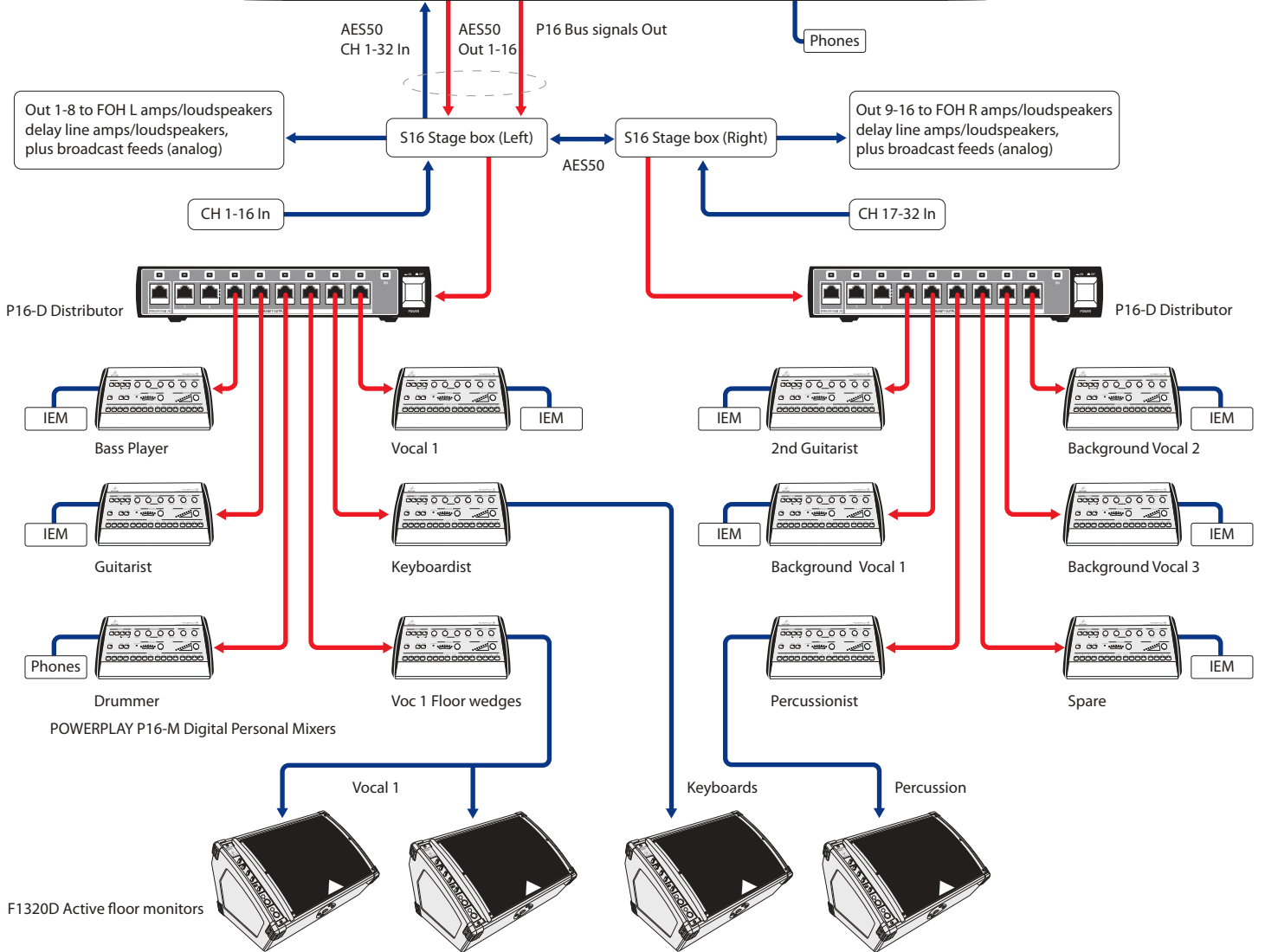
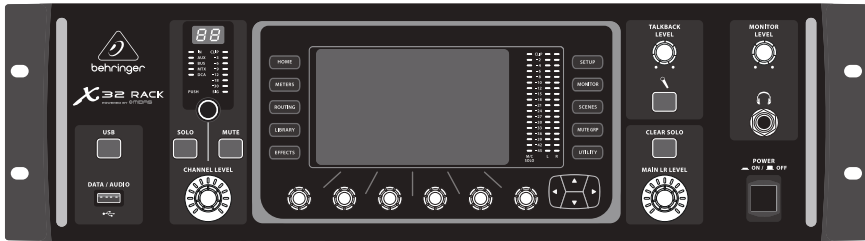
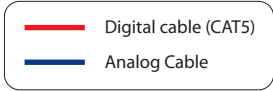

F1320D Active floor monitors



### X32 RACK Recording Studio Setup

#### Control Room

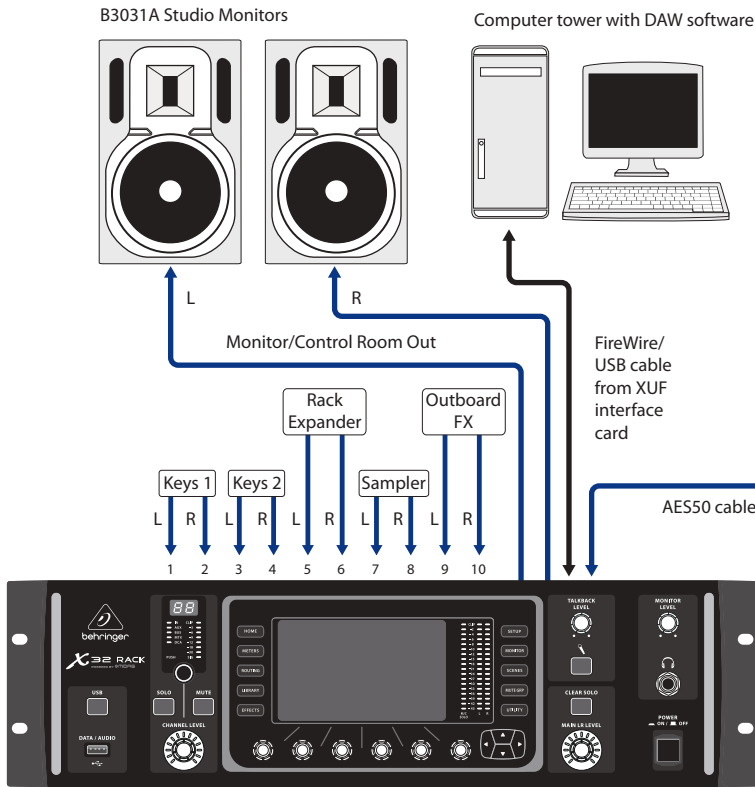

#### Recording Room

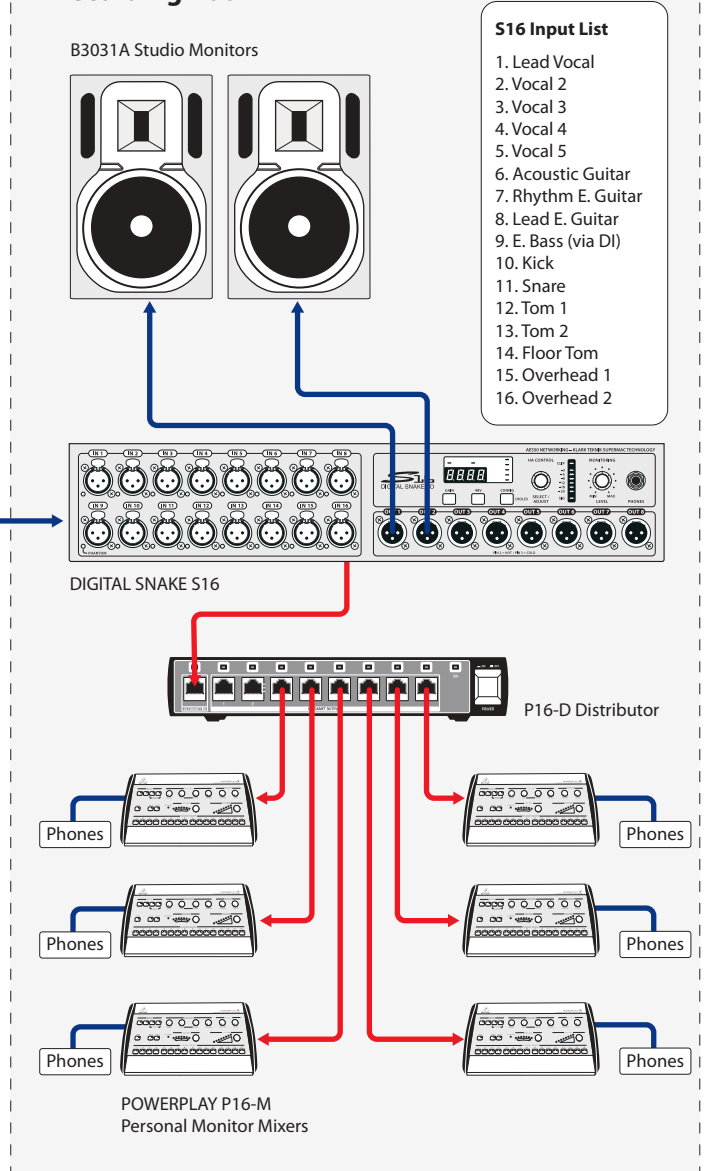





## Specifications

### Processing

Number of processing channels	32 input channels, 8 aux in channels, 8 FX return channels, 16 buses, 6 matrices, main LRC
Internal effects engines, true-stereo / mono	8 / 16
Internal total recall scenes (inkl. preamp and fader)	100
Signal processing	40-bit floating point
A/D-D/A conversion (Cirrus Logic A/D CS5368, D/A CS4385)	24-bit @ 44.1 / 48 kHz, 114 dB dynamic range
Local I/O latency (local in > console processing* > local out)	0.8 ms
Networked I/O latency (stagebox in > console processing* > stagebox out)	1.1 ms
Total number of accessible input sources / outputs	150 / 158

### Connectors

XLR inputs, programmable mic preamps, designed by MIDAS	16
Talkback mic input, XLR	1 ext. (no internal mic)
RCA inputs/outputs	2/2
XLR outputs	8
Monitoring outputs, ¼" TRS balanced	2
Aux inputs/outputs, ¼" TRS, balanced	6/6
Phones outputs, ¼" TRS	1 stereo (in front panel)
Digital AES/EBU output, XLR	—
AES50 ports, SuperMAC	2
Expansion card (optional)	32 channel audio input/output, various standards
P-16 connector, Ultramet (no power supplied)	1
MIDI inputs / outputs	1 / 1
Ethernet, RJ45, rear panel, for remote control	1
USB Type A, top panel, for audio and data export/import	1

### Mic Input Characteristics

Preamp Design	MIDAS
THD + noise, 20 dB gain, 0 dBu out	< 0.006% A-weighted
Input impedance XLR, unbal. / bal.	5 kΩ / 10 kΩ
Non clip maximum input level, XLR	+23 dBu
Phantom Power, switchable per input	48 V
Equivalent input noise level, XLR (input shorted)	-128 dBu
CMRR, XLR, @ 20 dB gain (typical)	> 70 dB
CMRR, XLR, @ 40 dB gain	> 80 dB

### Input/Output Characteristics

Frequency range, @ 48 kHz sample rate, 0 dB to -1 dB	10 Hz - 22 kHz
Dynamic range, analog in to analog out (typical)	106 dB
A/D Dynamic range, preamp and converter (typical)	109 dB
D/A Dynamic range, converter and output	108 dB
Cross talk rejection @ 1 kHz, adjacent channels	100 dB
Output level, XLR, nom./max.	+4 dBu / +21 dBu
Output impedance, XLR, unbal. / bal.	75 Ω / 75 Ω
Input impedance TRS Jack, unbal. / bal.	20 kΩ / 40 kΩ
Non clip maximum input level, TRS	+16 dBu
Nominal output level, TRS	+4 dBu / +16 dBu
Output impedance, TRS, unbal. / bal.	150 Ω / 300 Ω
Phones output impedance / level	40 Ω / +25 dBm (stereo)
Residual noise level, XLR and TRS	-87 dBu A-weighted

### Indicators

Main Screen	5", 800x480, 262k color TFT
Main Meter	-57 dB, -54 dB, -51 dB, -48 dB, -45 dB, -42 dB, -39 dB, -36 dB, -33 dB, -30 dB, -27 dB, -24 dB, -21 dB, -18 dB, -15 dB, -12 dB, -10 dB, -8 dB, -6 dB, -4 dB, -3 dB, -2 dB, -1 dB, Clip
Rear Panel	—

### Power

Switch-mode autorange power supply	100-240 V (50/60 Hz)
Power consumption	120 W

### Physical

Dimensions	132 x 483 x 287 mm (5.2 x 19 x 11.3")
Weight	6.5 kg (14.4 lbs)

\*incl. all channel and bus processing, excl. insert effects and line delays

Please note these specifications are preliminary and conceptual in nature, and as such are subject to change as product development progresses. This information is supplied for market research purposes only and is not to be made public in any manner. This document is solely the property of The MUSIC Group, or one of its subsidiaries, and must be surrendered upon request of the owner.

For service, support or more information contact the BEHRINGER location nearest you:

**Europe**  
MUSIC Group Services UK  
Tel: +44 156 273 2290  
Email: CARE@music-group.com

**USA/Canada**  
MUSIC Group Services NV Inc.  
Tel: +1 702 800 8290  
Email: CARE@music-group.com

**Japan**  
MUSIC Group Services JP K.K.  
Tel.: +81 3 6231 0454  
Email: CARE@music-group.com

Technical specifications and appearances are subject to change without notice and accuracy is not guaranteed. BEHRINGER, KLARK TEKNIK, MIDAS, BUGERA, and TURBOSOUND are part of the MUSIC Group (music-group.com). FireWire, Mac, iPod touch, iPhone, iPad, and iPad mini are trademarks of Apple Inc., registered in the U.S. and other countries. The AES50 trademark is a property of the Audio Engineering Society, NY. All trademarks, including, but not limited to Lexicon, PCM, EMT, Quantec and QRS are trademarks or registered trademarks of their respective owners. Their use neither constitutes a claim of the trademarks nor affiliation of the trademark owners with MUSIC Group. Product names are mentioned solely as a reference for X32 RACK compatibility and effects. MUSIC Group accepts no liability for any loss which may be suffered by any person who relies either wholly or in part upon any description, photograph or statement contained herein. Colors and specifications may vary from actual product. MUSIC Group products are sold through authorized fulfillers and resellers only. Fulfillers and resellers are not agents of MUSIC Group and have absolutely no authority to bind MUSIC Group by any express or implied undertaking or representation. This manual is copyrighted. No part of this manual may be reproduced or transmitted in any form or by any means, electronic or mechanical, including photocopying and recording of any kind, for any purpose, without the express written permission of MUSIC Group IP Ltd. ALL RIGHTS RESERVED © 2013 MUSIC Group IP Ltd. Trident Chambers, Wickhams Cay, P.O. Box 146, Road Town, Tortola, British Virgin Islands.

behringer.com

