

BOSE[®]



CC-1
CC-2
CC-3

ControlCenter Zone Controllers

Installation and Operation Guide
Guía de Instalación y Funcionamiento
Guide d'installation et utilisation
Installations- und Bedienungsanleitung
Manuale di installazione e funzionamento
Installatie- en bedieningshandleiding

BOSE PROFESSIONAL

pro.bose.com

Please read this owner's guide carefully and save it for future reference.

This product is intended for installation by professional installers only! This document is intended to provide professional installers with basic installation and safety guidelines for this product in typical fixed-installation systems. Please read this document before attempting installation.

WARNING:

- All Bose products must be installed in accordance with local, state, federal and industry regulations. It is the installer's responsibility to ensure installation of the loudspeakers and mounting system is performed in accordance with all applicable codes, including local building codes and regulations. Consult the local authority having jurisdiction before installing this product.
- To reduce the risk of fire or electrical shock, do not expose the product to rain or moisture.
- Do not expose this apparatus to dripping or splashing, and do not place objects filled with liquids such as vases, on or near the apparatus. Exposure to liquid may create a fire hazard.
- Do not place any naked flame sources, such as lighted candles, on or near the apparatus.
- This product is not intended for installation or use in indoor water facility areas (including, without limitation, indoor pools, indoor water parks, hot tub rooms, saunas, steam rooms and indoor skating rinks).



Contains small parts which may be a choking hazard. Not suitable for children under age 3.

CAUTION:

- Do not make unauthorized alterations to the product; doing so may compromise safety, regulatory compliance, system performance, and may void the warranty.



The exclamation point within an equilateral triangle, as marked on the system, is intended to alert the user to the presence of important operating and maintenance instructions in this installation guide.

1. Read these instructions.
2. Keep these instructions.
3. Heed all warnings.
4. Follow all instructions.
5. Do not use this apparatus near water.
6. Clean only with a dry cloth.
7. Do not block any ventilation openings. Install in accordance with the manufacturer's instructions.
8. Do not install near any heat sources, such as radiators, heat registers, stoves or other apparatus (including amplifiers) that produce heat.
9. Only use attachments/accessories specified by the manufacturer.
10. Refer all servicing to qualified personnel. Servicing is required when the apparatus has been damaged in any way, such as power-supply cord or plug is damaged, liquid has been spilled or objects have fallen into the apparatus, the apparatus has been exposed to rain or moisture, does not operate normally, or has been dropped.



This product conforms to all applicable EU directive requirements. The complete Declaration of Conformity can be found at www.Bose.com/compliance

Product Features

Bose® ControlCenter zone controllers provide three options for remote volume control and input source selection:

Controller	Function	Compatible Products
CC-1	Volume control only	FreeSpace® IZA 2120-LZ/HZ FreeSpace ZA 2120-LZ/HZ PowerShare PS602 & PS604 Any ControlSpace® engineered sound processor
CC-2	Volume control with A/B source selection switch	FreeSpace IZA 250-LZ; IZA 190-HZ FreeSpace IZA 2120-LZ/HZ Any ControlSpace engineered sound processor
CC-3	Volume control with A/B/C/D source selection switch	Any ControlSpace engineered sound processor

Each zone controller is available in white and black, and in North America, Japan, and EU configurations. The North America zone controllers are sized for Decora® wall mounting, and include two 1/2 inch #6-32 screws. The Japan zone controllers fit Wide 21 wall plates with a face height of 1 mm above the thick wall plate cover; the controllers have approximately 3 mm face height when used with other types of wall plate covers. Two 8 mm M4 screws are included. Wall plate covers are not included with North America and Japan zone controllers. The EU zone controllers come as a finished wall plate of size 86 mm x 86 mm, with 60 to 60.3 mm screw spacing suitable for either vertical or horizontal mounting, and include two 18 mm M4 screws. All models include a sheet of pre-printed color-matched labels, plus two blank labels for customized applications.

Connecting a Single Zone Controller

Connect a single zone controller to a FreeSpace or PowerShare amplifier using a CAT 5 cable with maximum length of 609 meters (2000 feet). Connect to a ControlSpace ESP using a CAT 5 cable with a maximum length of 152 meters (500 feet) for a shielded cable or 30 meters (100 feet) for an unshielded cable.

The cable must be terminated on one end with an RJ-45 connection using TIA/EIA 568B pinout, and on the other end with an RJ-45 connector for PowerShare amplifiers, or the Euroblock connector appropriate for the FreeSpace amplifier or ControlSpace engineered sound processor (2-pin, 4-pin, or 6-pin).

Connecting Multiple Zone Controllers

Some amplifier models allow adjacent zone controllers to be ganged together directly. Each zone controller can be independently configured to control any output, or combination of outputs, for bi-amping.

Use a CAT 5 cable with RJ-45 connectors to connect zone controllers to each other, then create a single home run from the last zone controller in the chain back to the amplifier. The maximum total cable length (from the first zone controller to the amplifier) is 609 meters (2000 feet). Use standard CAT 5 cables and RJ-45 connectors as described in Connecting a Single Controller.

CV41 4-to-1 Converter

For PowerShare amplifier models, you can use the CV41 4-to-1 Converter to create a single home run back to an amplifier from multiple zone controllers distributed throughout an installation. Connect each zone controller to the CV41 converter using CAT 5 cables with RJ-45 connectors, then run a single CAT 5 cable from the CV41 4-to-1 Converter to the amplifier. You can connect up to two CC-1 zone controllers to a PS602 amplifier, and up to four CC-1 zone controllers to a PS604 amplifier.

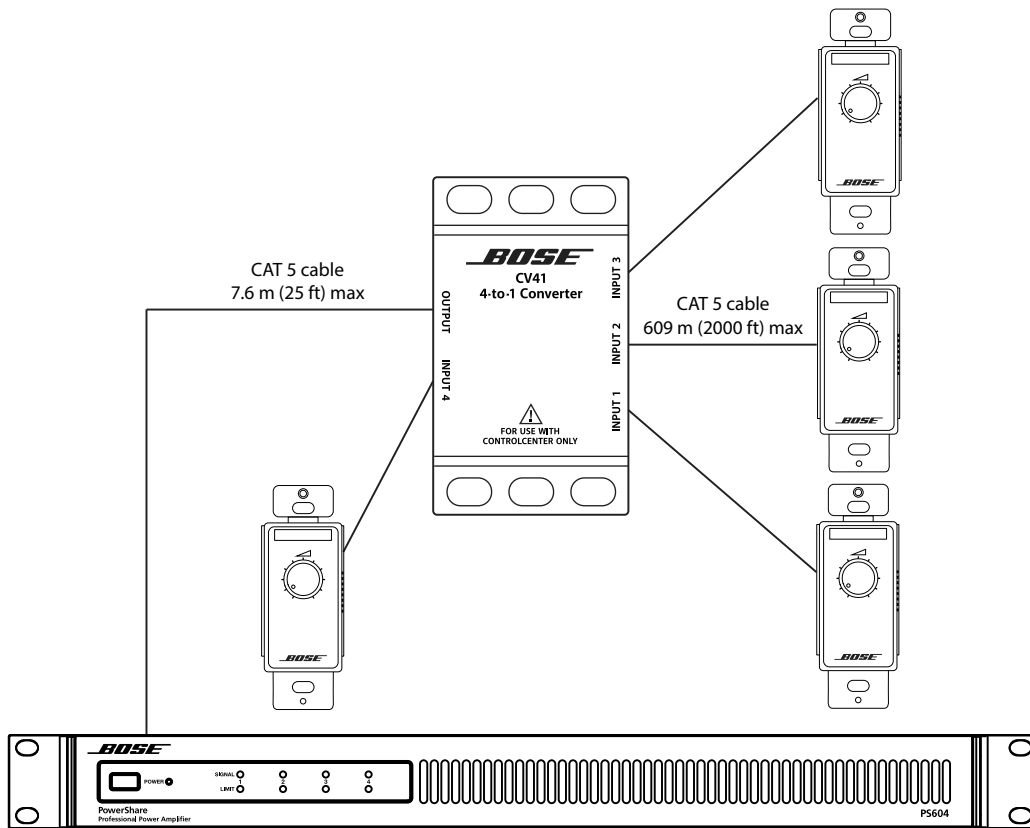

CC-1 Zone Controller

The CC-1 zone controller provides volume control only. It is compatible with FreeSpace® IZA 2120-LZ/HZ and ZA 2120-LZ/HZ amplifiers, PowerShare PS602 and PS604 amplifiers, and any ControlSpace® engineered sound processor (ESP).

CC-1 Zone Controller - North America

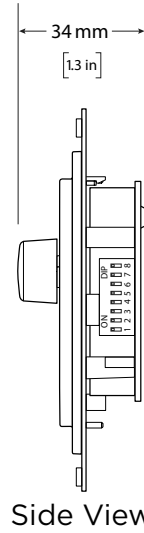
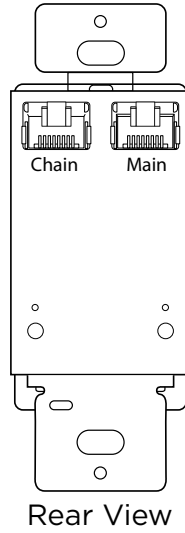
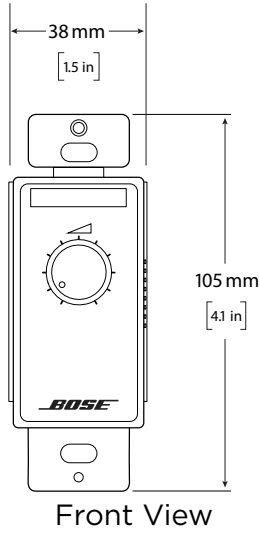

CC-1 Zone Controller - Japan

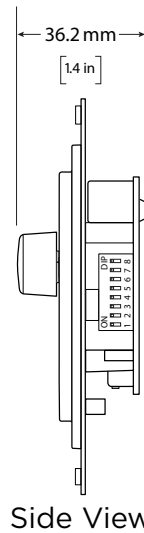
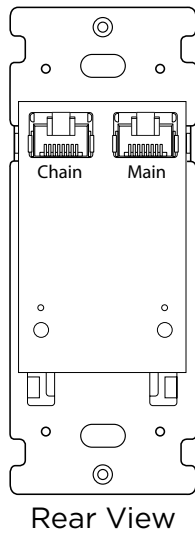
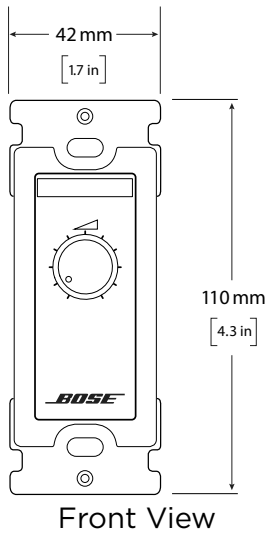

CC-1 Zone Controller - EU

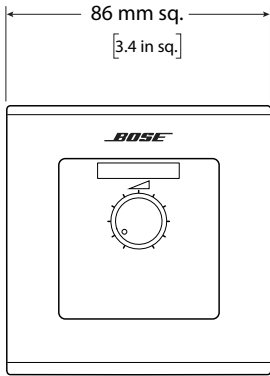

Front View

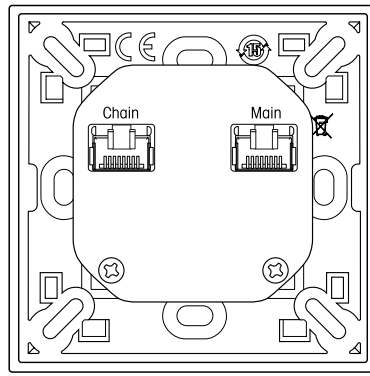

Rear View

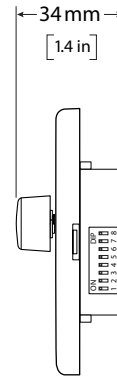

Side View

Pin-to-Remote Connections

Connections from the RJ-45 (TIA/EIA 568B wiring) connector on the CC-1 zone controller to the REMOTE connector on the FreeSpace® amplifier or CONTROL INPUTS connector on the ControlSpace® engineered sound processor (ESP).

Pin	Color	FreeSpace	ControlSpace ESP
8	Brown		
7	White/Brown		
6	Green		
5	White/Blue		
4	Blue	VOL 2	
3	White/Green	VOL 1	VOL 1
2	Orange	PWR #2	
1	White/Orange	PWR #1	PWR #1

Connecting the CC-1 Zone Controller

Connect one CC-1 zone controller to FreeSpace® amplifier models IZA 2120-LZ/HZ or ZA 2120-LZ/HZ, PowerShare amplifier models PS602 or PS604, or any ControlSpace® engineered sound processor (ESP).

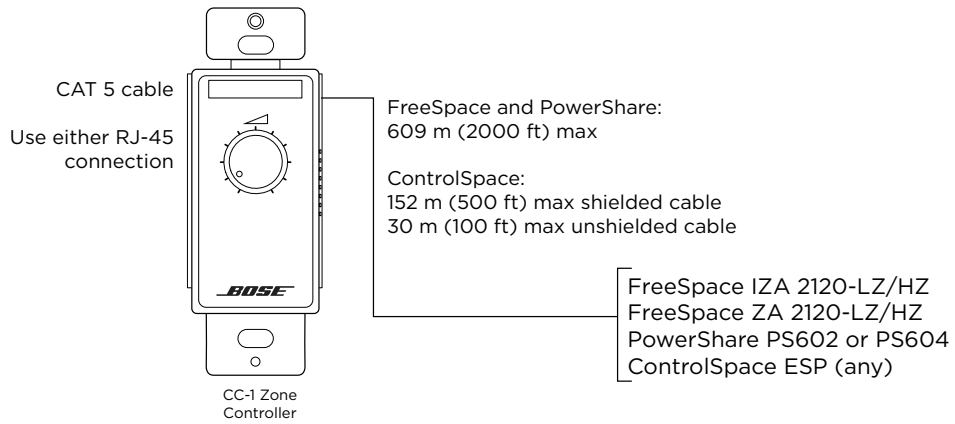

Pin-to-Remote Connection Diagrams

Either RJ-45 on CC-1 Zone Controller

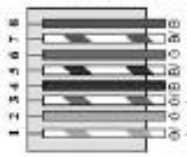

FreeSpace IZA 2120-LZ/HZ

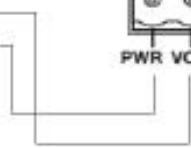
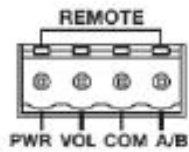

Either RJ-45 on CC-1 Zone Controller

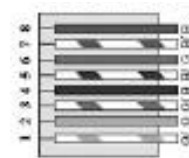

FreeSpace ZA 2120-LZ/HZ

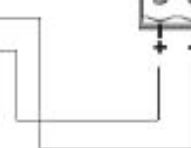

Either RJ-45 on CC-1 Zone Controller



Any ControlSpace ESP

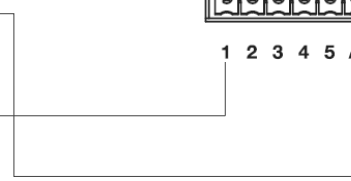
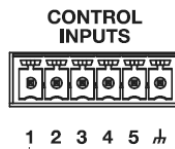

Configure the CC-1 zone controller using the following DIP switch settings:

	1	2	3	4	5	6	7	8
FreeSpace	0	0	1	0	1	0	0	0
PowerShare*	0	0	1	0	*	*	*	*
ControlSpace	0	0	1	0	1	0	0	0

* For the PowerShare PS602 and PS604 amplifiers, the CC-1 controls any outputs with corresponding DIP switches in the ON position:

DIP 5 - OUTPUT 1

DIP 6 - OUTPUT 2

DIP 7 - OUTPUT 3 (PS604 only)

DIP 8 - OUTPUT 4 (PS604 only)

Connect two ganged CC-1 zone controllers to FreeSpace® amplifier models IZA 2120-HZ or ZA 2120-HZ, or PowerShare amplifier models PS602 or PS604.

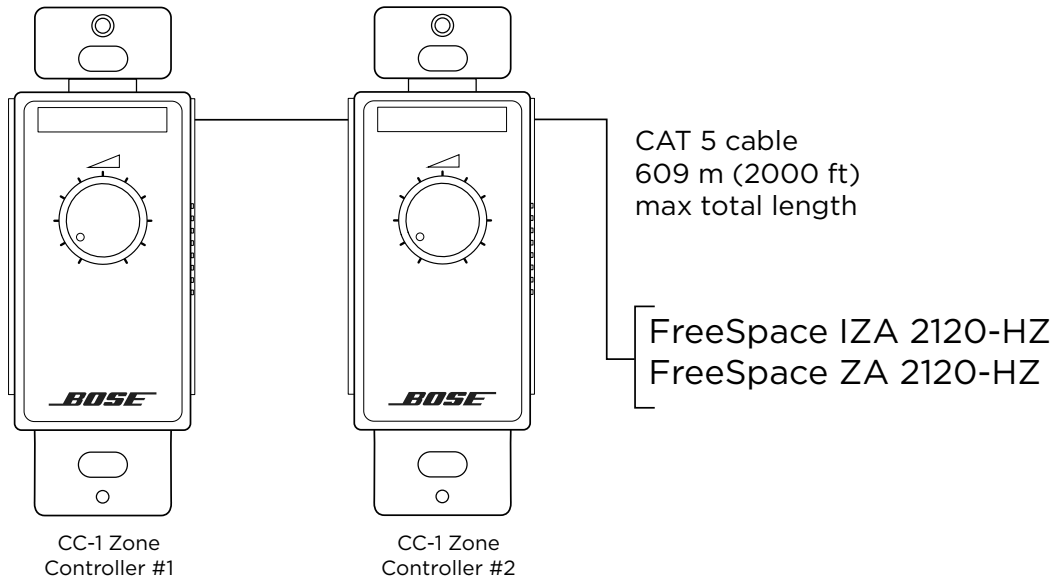

Pin-to-Remote Connection Diagrams

RJ-45 #1 (Main) on
CC-1 Zone Controller #2

FreeSpace IZA 2120-HZ

RJ-45 #1 (Main) on
CC-1 Zone Controller #2

FreeSpace ZA 2120-HZ

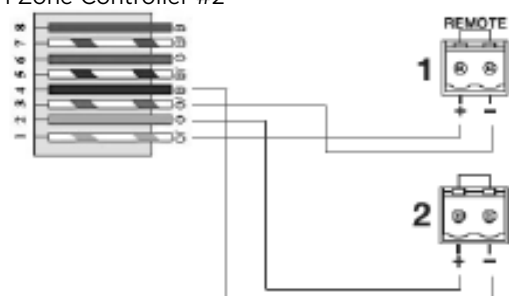
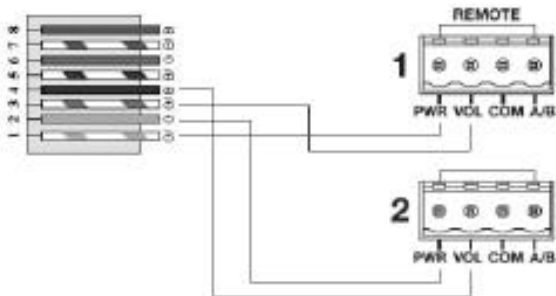

Configure the CC-1 zone controllers using the following DIP switch settings:

		1	2	3	4	5	6	7	8
FreeSpace	Controller #1	0	0	1	0	1	0	0	0
	Controller #2	0	0	0	1	0	1	0	0
PowerShare*	Controller #1	0	0	1	0	*	*	*	*
	Controller #2	0	0	1	0	*	*	*	*

* For the PowerShare PS602 and PS604 amplifiers, the CC-1 controls any outputs with corresponding DIP switches in the ON position:

DIP 5 - OUTPUT 1

DIP 6 - OUTPUT 2

DIP 7 - OUTPUT 3 (PS604 only)

DIP 8 - OUTPUT 4 (PS604 only)

FreeSpace Amplifiers

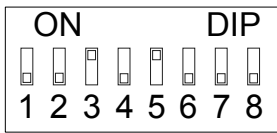

CC-1 Zone Controller #1

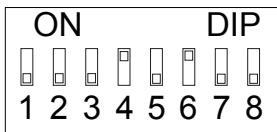

CC-1 Zone Controller #2

PowerShare Amplifiers

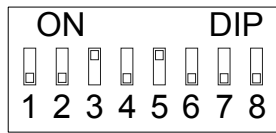

CC-1 Zone Controller #1

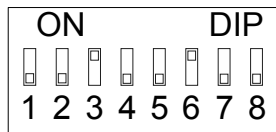

CC-1 Zone Controller #2

Connect up to four ganged CC-1 zone controllers to the PowerShare amplifier model PS604.

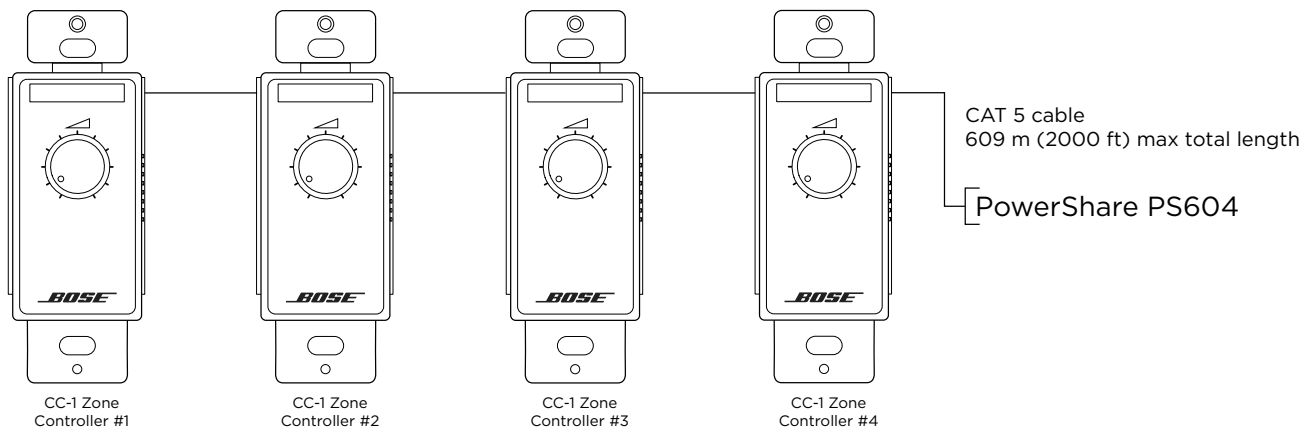

Configure the CC-1 zone controllers using the following DIP switch settings:

	1	2	3	4	5	6	7	8
Controller #1	0	0	1	0	1	0	0	0
Controller #2	0	0	1	0	0	1	0	0
Controller #3	0	0	1	0	0	0	1	0
Controller #4	0	0	1	0	0	0	0	1

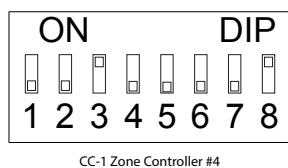
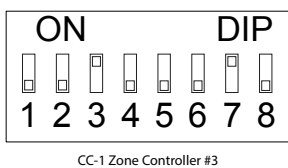
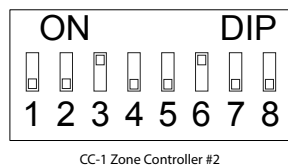
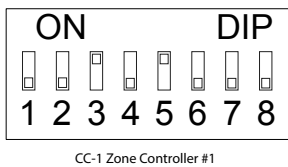

Connect multiple CC-1 zone controllers to PowerShare amplifier models PS602 or PS604 using the CV41 4-to-1 converter. Connect up to two CC-1 zone controllers to the PS602 amplifier or up to four CC-1 zone controllers to the PS604 amplifier.

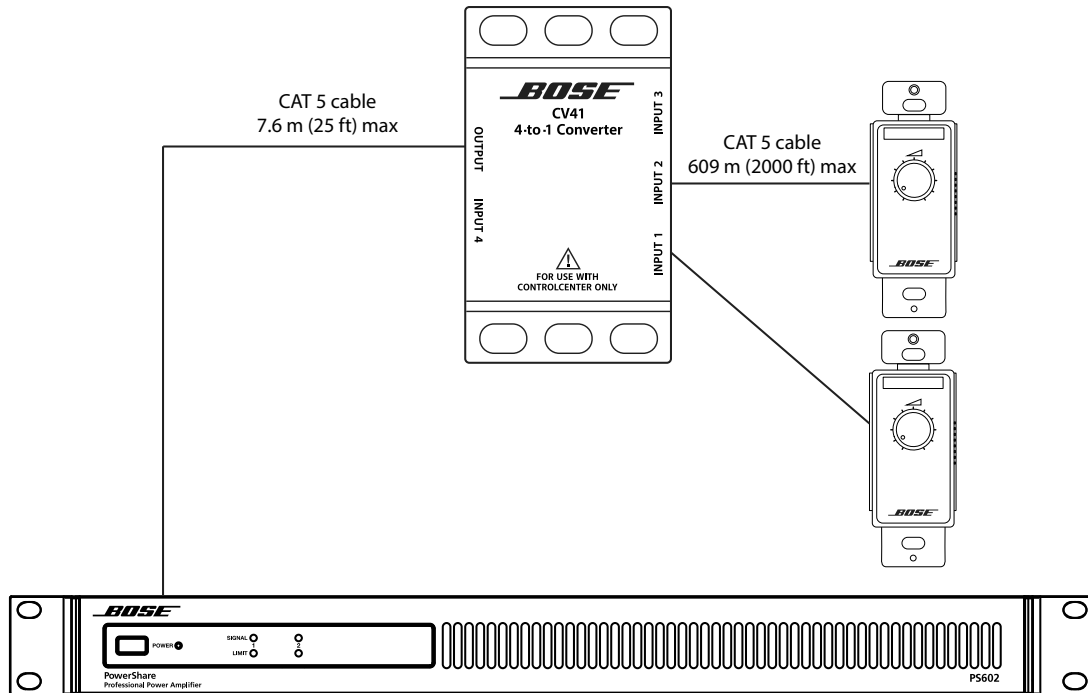

Configure the CC-1 zone controllers using the following DIP switch settings:

	1	2	3	4	5	6	7	8
Controller #1	0	0	1	0	1	0	0	0
Controller #2	0	0	1	0	0	1	0	0

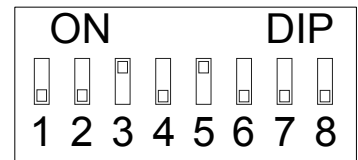

CC-1 Zone Controller #1

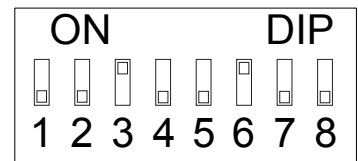

CC-1 Zone Controller #2

Connect up to four CC-1 zone controllers to the PowerShare PS604 amplifier using the CV41 4-to-1 converter.

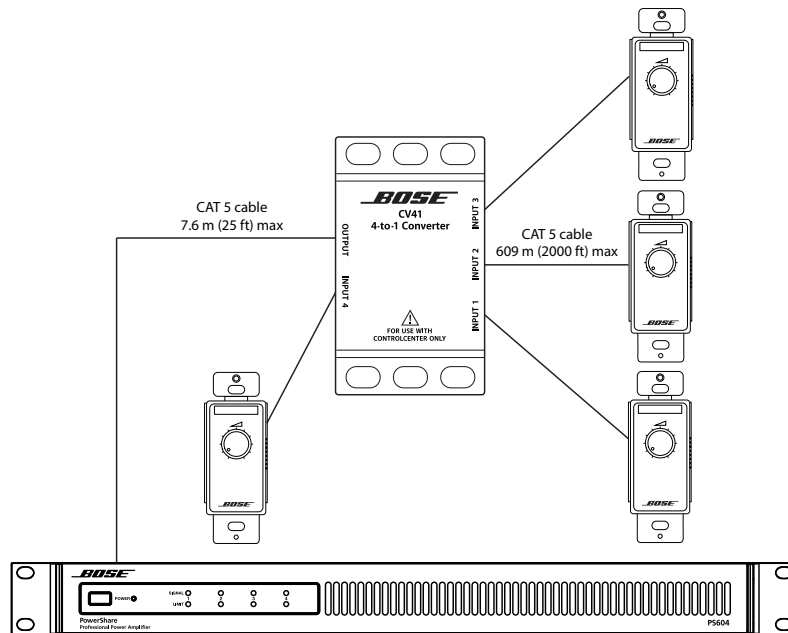

Configure the CC-1 zone controllers using the following DIP switch settings:

	1	2	3	4	5	6	7	8
Controller #1	0	0	1	0	1	0	0	0
Controller #2	0	0	1	0	0	1	0	0
Controller #3	0	0	1	0	0	0	1	0
Controller #4	0	0	1	0	0	0	0	1

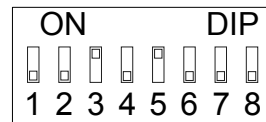

CC-1 Zone Controller #1

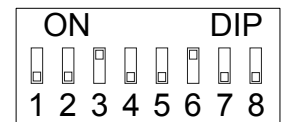

CC-1 Zone Controller #2



CC-1 Zone Controller #3

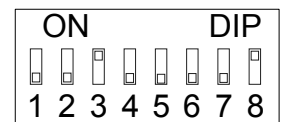

CC-1 Zone Controller #4

CC-2 Zone Controller

The CC-2 zone controller provides volume control and A/B source selection. It is compatible with FreeSpace® amplifier models IZA 250-LZ, IZA 190-HZ, and IZA 2120-LZ/HZ, and any ControlSpace® engineered sound processor (ESP).

CC-2 Zone Controller - North America

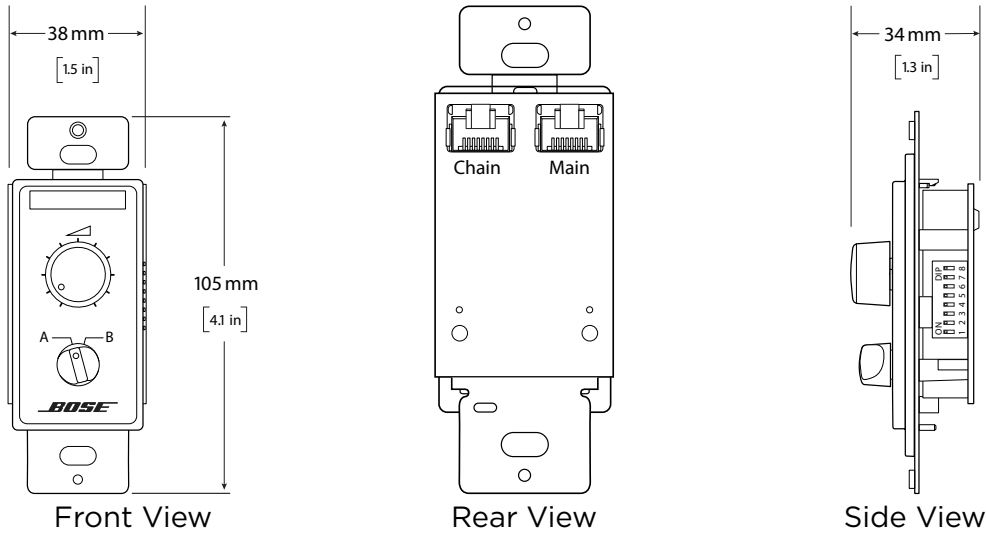

CC-2 Zone Controller - Japan

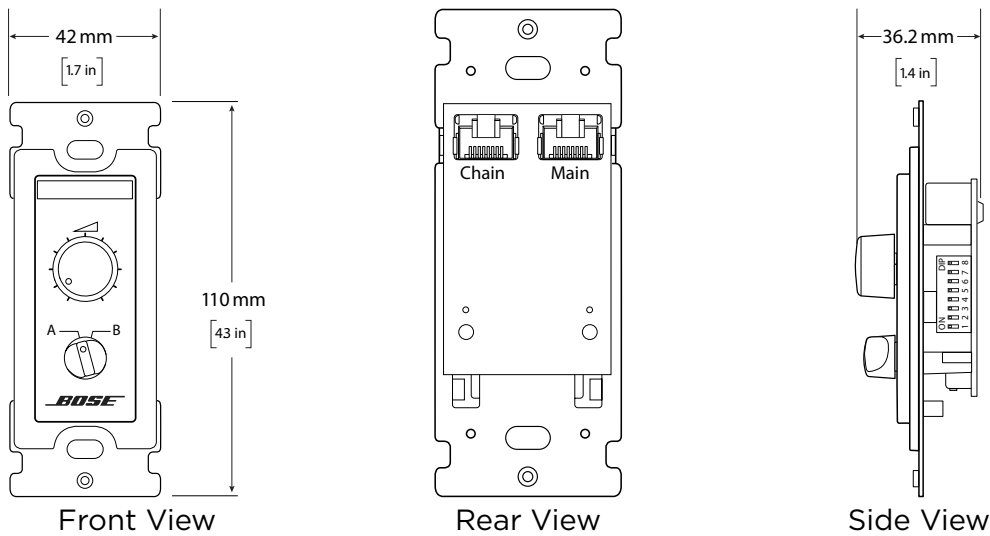

CC-2 Zone Controller - EU

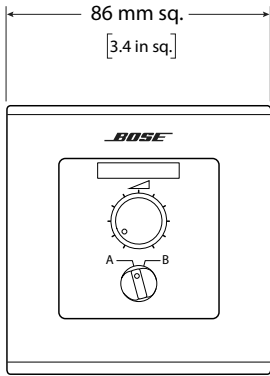

Front View

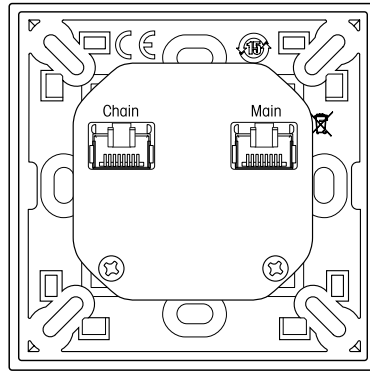

Rear View

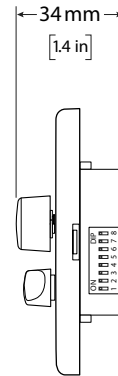

Side View

Pin-to-Remote Connections

Connections from the RJ-45 (TIA/EIA 568B wiring) connector on the CC-2 zone controller to REMOTE connector on the FreeSpace® amplifier or to CONTROL INPUTS connector on the ControlSpace® engineered sound processor (ESP).

Pin	Color	FreeSpace IZA	ControlSpace ESP
8	Brown		
7	White/Brown	A/B Select #2	
6	Green	A/B Select #1	A/B Select #1
5	White/Blue		
4	Blue	VOL 2	
3	White/Green	VOL 1	VOL 1
2	Orange	PWR #2	
1	White/Orange	PWR #1	PWR #1

Connecting the CC-2 Zone Controller

Connect one CC-2 zone controller to FreeSpace® amplifier models IZA 250-LZ, IZA 190-HZ, and IZA 2120-LZ/HZ, and any ControlSpace® engineered sound processor (ESP).

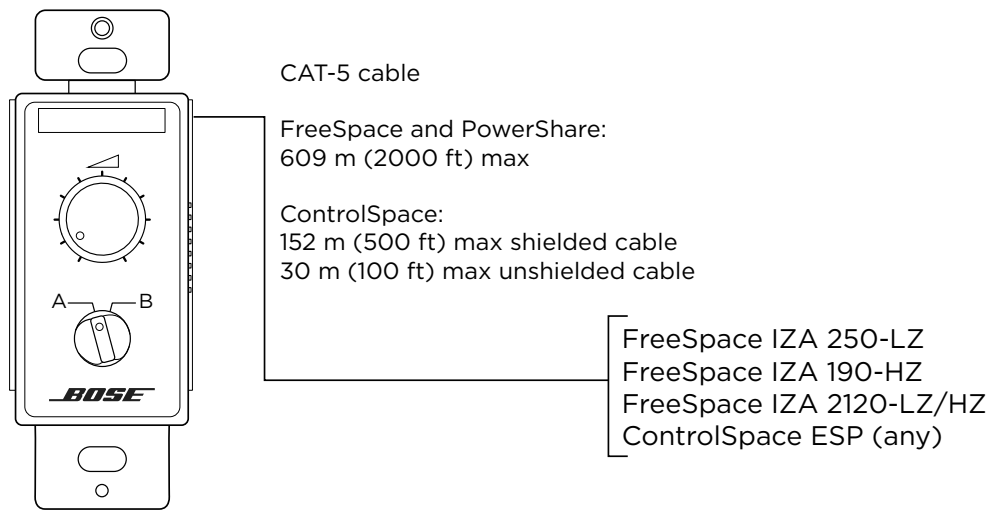

Pin-to-Remote Connection Diagrams

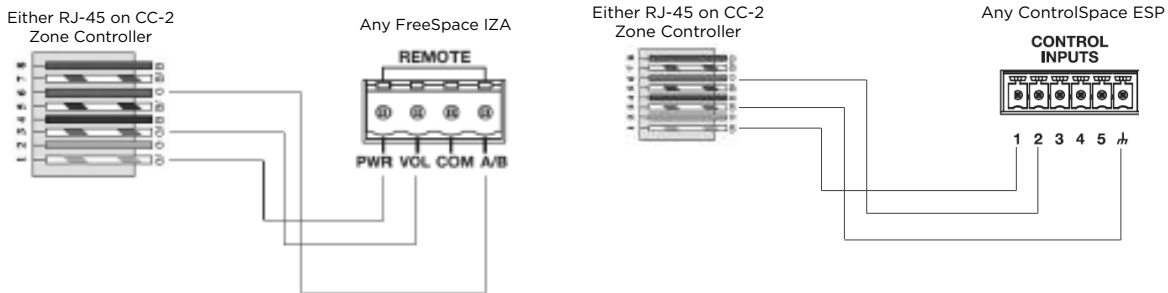

Configure one CC-2 zone controller using the following DIP switch settings:

	1	2	3	4	5	6	7	8
Controller	1	0	1	0	1	0	0	0

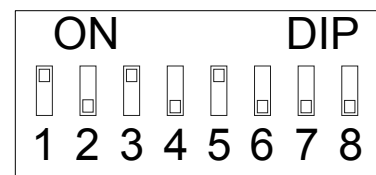

CC-2 Zone Controller

Connect two ganged CC-2 zone controllers to FreeSpace® amplifier model IZA 2120-HZ.

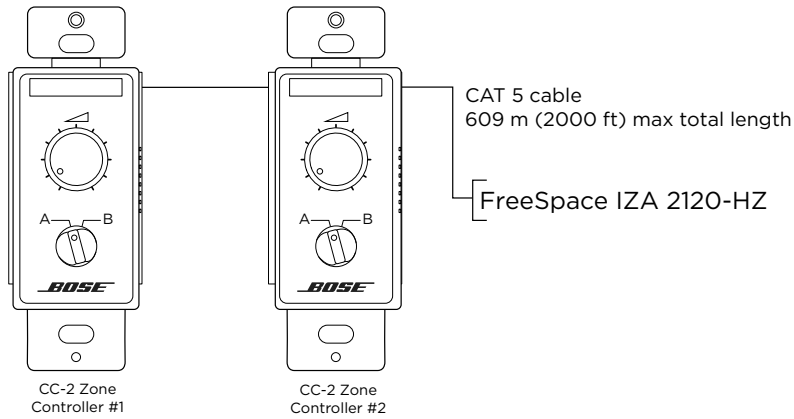

Pin-to-Remote Connection Diagrams

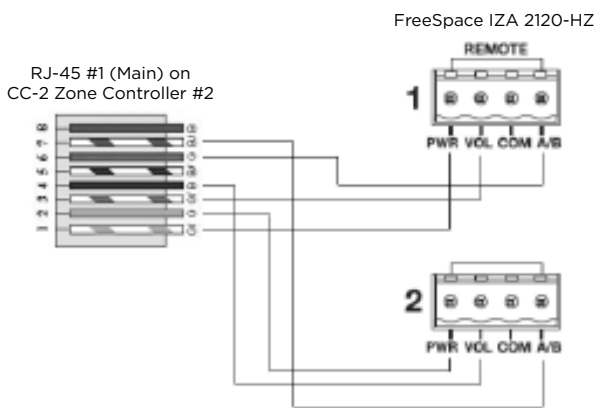

Configure two ganged CC-2 zone controllers using the following DIP switch settings:

Switch	1	2	3	4	5	6	7	8
Controller #1	1	0	1	0	1	0	0	0
Controller #2	0	1	0	1	0	1	0	0

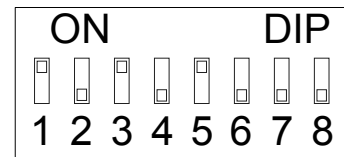

CC-2 Zone Controller #1

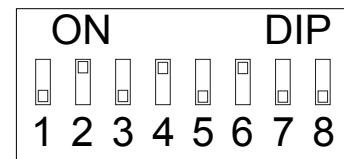

CC-2 Zone Controller #2

CC-3 Zone Controller

The CC-3 zone controller provides volume control and A/B/C/D source selection. It is compatible with any ControlSpace® engineered sound processor (ESP).

CC-3 Zone Controller - North America

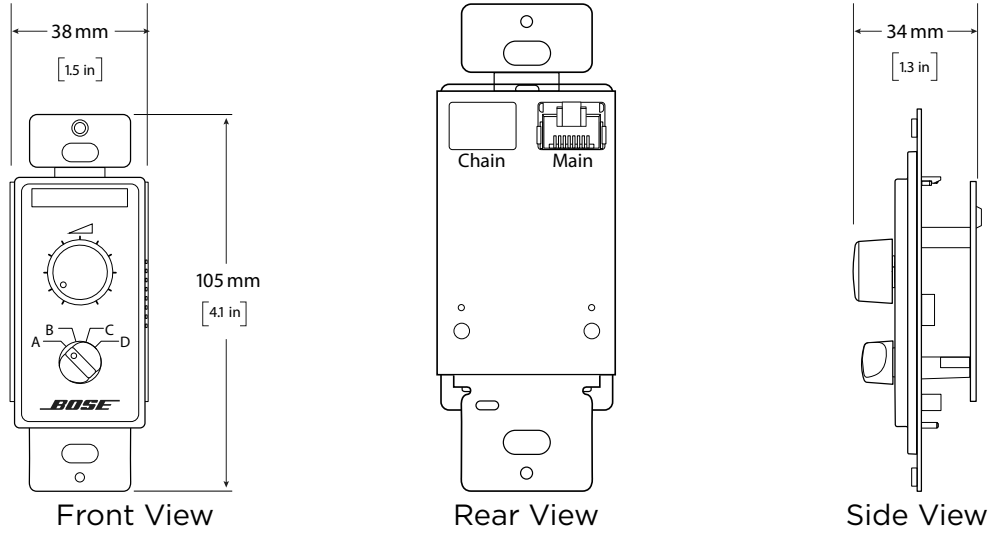

CC-3 Zone Controller - Japan

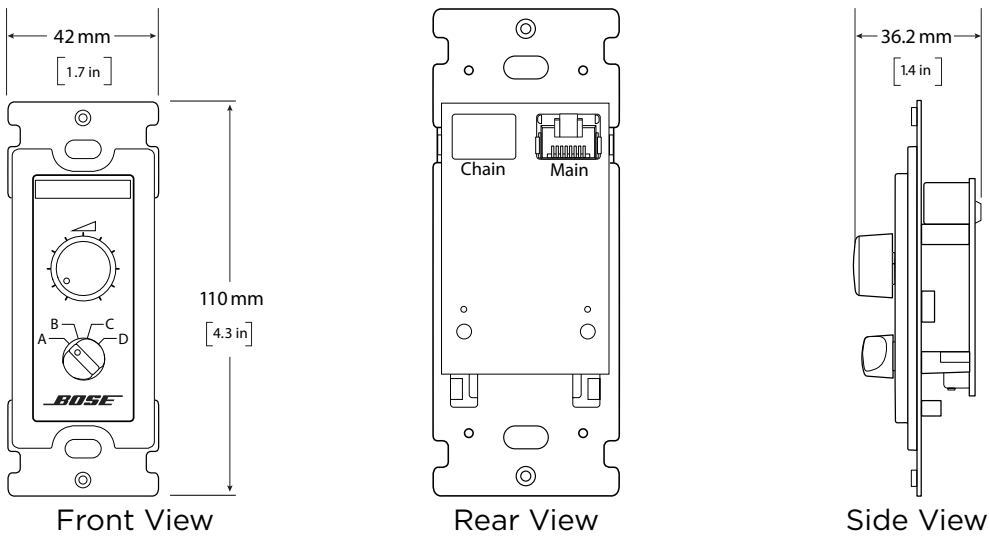

CC-3 Zone Controller - EU

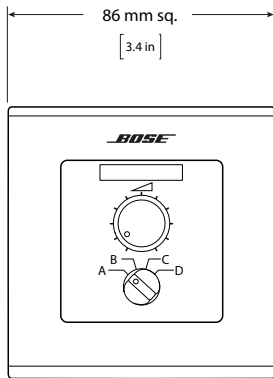

Front View

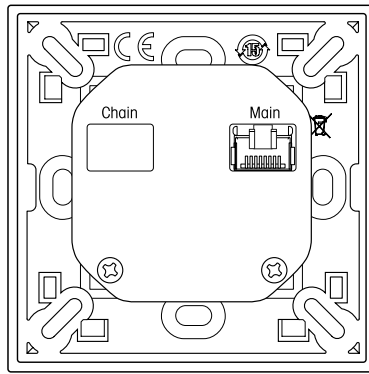

Rear View

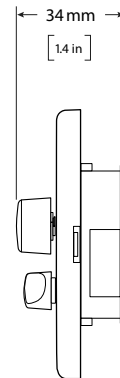

Side View

Pin-to-Remote Connections

Connections from the RJ-45 (TIA/EIA 568B wiring) connector on the CC-3 zone controller to the CONTROL INPUTS connector on the ESP.

Pin	Color	ControlSpace ESP
8	Brown	COM
7	White/Brown	A
6	Green	B
5	White/Blue	C
4	Blue	D
3	White/Green	VOL
2	Orange	
1	White/Orange	

Connecting the CC-3 Zone Controller

Connect one CC-3 zone controller to any ControlSpace® engineered sound processor (ESP).

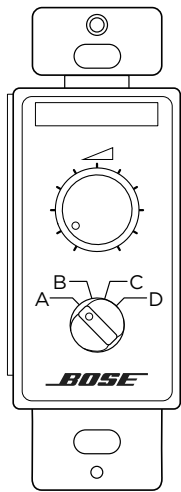

Any ControlSpace ESP

152 m (500 ft) max length CAT 5 shielded cable
30 m (100 ft) max length unshielded CAT 5 cable

Terminated with RJ-45 (TIA/EIA 568 pinout) on one end
and 6-pin phoenix on the other end

Pin-to-Remote Connection Diagrams

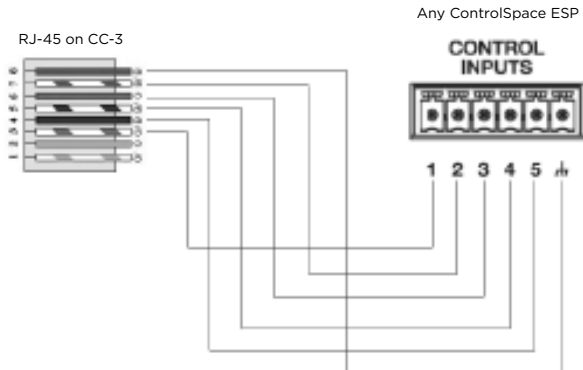

Limited Warranty

Your product is covered by a limited warranty, Visit **pro.Bose.com** for warranty details.

The warranty information provided with this product does not apply in Australian and New Zealand. See our website at **www.bose.com/au/warranty** or **www.bose.com/nz/warranty** for details of the Australian and New Zealand warranty.

Decora® is a registered trademark of Leviton Manufacturing Co., Inc.

Importer Information

European Union

Bose GP, Castleblayney Road, Carrickmacross, County Monaghan, Ireland

China

Bose Electronics (Shanghai) Company Limited, Part C, Plan 9, No. 353 North Riying Road, China (Shanghai) Pilot Free Trade Zone

Taiwan

Bose Taiwan Branch, 9F-A1, No. 10, Section 3, Minsheng East Road, Taipei City 104, Taiwan

Mexico

Bose de México, S. de R.L. de C.V., Paseo de las Palmas 405-204, Lomas de Chapultepec, 11000 México, D.F.

Contact Information

Visit us on the web at pro.Bose.com.

Americas

(USA, Canada, Mexico, Central America, South America)
Bose Corporation
The Mountain
Framingham, MA 01701 USA
Corporate Center: 508-879-7330
Americas Professional Systems,
Technical Support: 800-994-2673

Australia

Bose Pty Limited
Unit 3/2 Holker Street
Newington NSW Australia
TEL 61 2 8737 9999

Belgium

Bose N.V. / S.A
Limesweg 2, 03700
Tongeren, Belgium
TEL (32) 012-390800

China

Bose Electronics (Shanghai) Co Ltd
36F, West Gate Tower
1038 West Nanjing Road
Shanghai, P.R.C. 200041 China
TEL 86 21 6271 3800

France

Bose S.A.S
12 rue de Temara
78100 St. Germain en Laye, France
TEL 01-30-61-63-63

Germany

Bose GmbH
Max-Planck Strasse 36D 61381
Friedrichsdorf, Deutschland
TEL 06172-7104-0

Hong Kong

Bose Limited
Suites 2101-2105, Tower One, Times Square
1 Matheson Street, Causeway Bay, Hong Kong
TEL 852 2123 9000

India

Bose Corporation India Private Limited
Salcon Aurum, 3rd Floor
Plot No. 4, Jasola District Centre
New Delhi - 110025, India
TEL 91 11 43080200

Italy

Bose SpA
Centro Leoni A - Via G. Spadolini
5 20122 Milano, Italy
TEL 39-02-36704500

Japan

Bose Kabushiki Kaisha
Shibuya YT Building
28-3 Maruyama-sho
Shibuya-Ku, Tokyo, 150, Japan
TEL 81-3-5489-0955
www.bose.co.jp

The Netherlands

Bose BV
Nijverheidstraat 8 1135 GE
Edam, Nederland
TEL 31 (0)299-390139

United Kingdom

Bose House
Quayside Chatham Maritime
Chatham, Kent ME4 4QZ, United Kingdom
TEL 44 (0)3330-142545

See website for other countries

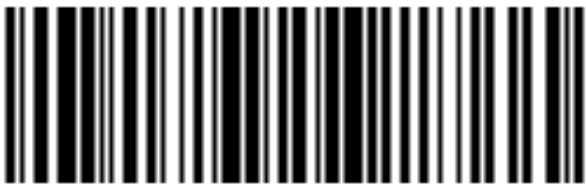

771705-0010

BOSE[®]

©2016 Bose Corporation, The Mountain,
Framingham, MA 01701-9168 USA
AM771705 Rev. 00