



## **Bose® Panaray® MSA12X** Modular Steerable Array Loudspeaker

Installation Guide\*  
Guía de instalación\*  
Guide d'installation\*  
Installationsanleitung\*  
Guida all'installazione\*  
Installatiehandleiding\*

- \* For use by professional installers only.
- \* Para uso exclusivo de instaladores capacitados.
- \* Réservé aux installateurs ayant suivi une formation.
- \* Montage ausschließlich durch ausgebildetes Installationspersonal.
- \* Solo per l'uso da parte di installatori professionisti.
- \* Uitsluitend voor gebruik door ervaren installateurs.

## Please read and keep all safety and use instructions.

**This product is intended for installation by professional installers only!** This document is intended to provide professional installers with basic installation and safety guidelines for this product in typical fixed-installation systems. Please read this document and all safety warnings before attempting installation.

### Important Safety Instructions:

1. Read these instructions.
2. Keep these instructions.
3. Heed all warnings.
4. Follow all instructions.
5. Do not use this apparatus near water.
6. Clean only with a dry cloth.
7. Do not block any ventilation openings. Install in accordance with the manufacturer's instructions.
8. Do not install near any heat sources, such as radiators, heat registers, stoves, or other apparatus (including amplifiers) that produce heat.
9. Do not defeat the safety purpose of the polarized or grounding-type plug. A polarized plug has two blades with one wider than the other. A grounding type plug has two blades and a third grounding prong. The wide blade or the third prong are provided for your safety. If the provided plug does not fit into your outlet, consult an electrician for replacement of the obsolete outlet.
10. Protect the power cord from being walked on or pinched particularly at plugs, convenience receptacles, and the point where they exit from the apparatus.
11. Only use attachments/accessories specified by the manufacturer.
12. Use only with the cart, stand, tripod, bracket, or table specified by the manufacturer, or sold with the apparatus.
13. Unplug this apparatus during lightning storms or when unused for long periods of time.
14. Refer all servicing to qualified personnel. Servicing is required when the apparatus has been damaged in any way, such as power-supply cord or plug is damaged, liquid has been spilled or objects have fallen into the apparatus, the apparatus has been exposed to rain or moisture, does not operate normally, or has been dropped.



This symbol on the product means there is uninsulated, dangerous voltage within the product enclosure that may present a risk of electrical shock.



This symbol on the product means there are important operating and maintenance instructions in this guide.



Contains small parts which may be a choking hazard. Not suitable for children under age 3.



This product contains magnetic material. Consult your physician on whether this might affect your implantable medical device.

### For Japan:

Note: Provide an earth connection before the main plug is connected to the mains.



### For Denmark, Finland, Norway, and Sweden:

English: Provide an earth connection or ensure the socket outlet incorporates a protective earthing connection before connecting the plug to the mains socket outlet.

Denmark: Apparatets stikprop skal tilsluttes en stikkontakt med jord, som giver forbindelse til stikproppens jord.

Finland: Laite on liitettävä suojamaadoituskoskettimilla varustettuun pistorasiaan

Norway: Apparatet må tilkoples jordet stikkontakt.

Swedish: Apparaten skall anslutas till jordat uttag.

### Names and Contents of Toxic or Hazardous Substances and Elements

Part Name	Toxic or Hazardous Substances and Elements					
	Lead (Pb)	Mercury (Hg)	Cadmium (Cd)	Hexavalent (CR(VI))	Polybrominated Biphenyl (PBB)	Polybrominated diphenylether (PBDE)
PCBs	X	0	0	0	0	0
Metal parts	X	0	0	0	0	0
Plastic parts	0	0	0	0	0	0
Speakers	X	0	0	0	0	0
Cables	X	0	0	0	0	0

This table is prepared in accordance with the provisions of SJ/T 11364.  
 0: Indicates that this toxic or hazardous substance contained in all of the homogenous materials for this part is below the limit requirement of GB/T 26572.  
 X: Indicates that this toxic or hazardous substance contained in at least one of the homogenous materials used for this part is above the limit requirement of GB/T 26572.



仅适用于海拔 2000m 以下地区安全使用  
 Only suitable for use at areas with altitude less than 2000 m



仅适用于非热带气候条件下安全使用  
 Only suitable for use at non-tropic climate areas.

Complies with  
 IMA Standards  
 [Dealer's Licence No.]



## Product Overview

The Bose Professional Panaray® MSA12X is a digital beam-steering loudspeaker that enables improved room aesthetics, with outstanding vocal intelligibility and tonal consistency. The proprietary Articulated Array® transducer configuration allows wide, 160° horizontal coverage throughout the room, and MSA12X's modular design allows building of vertical arrays using one (1) to three (3) units. Dante® digital audio network interface comes standard for connection with other Dante-enabled products over Ethernet-based networks.

## Product Features

- **Digital beam-steering line array column loudspeaker** with onboard DSP and 600 watts (12 x 50 W) of amplification
- **Family sound profile** with the Panaray MA12EX Loudspeaker
- **Twelve (12) x 2.25-inch full-range transducers** with 80 Hz – 18 kHz frequency range
- **Dante® digital audio network interface and line-level analog input**
- **Articulated Array® configuration** allows wide, 160° horizontal coverage
- **Modular design** allows building vertical arrays using 1-3 units
- **Multiple algorithms for beam steering control** – designers can optimize consistency of coverage, tonal balance, and maximum SPL per job
- **Supports independent level and EQ control** of 2 separate beams per array
- **Integrated mounting bracket** allows up 90° of horizontal yaw adjustment
- **Advanced steering and acoustic coverage prediction** using Bose Modeler® software
- **System setup, control and monitoring** with Bose ControlSpace® Designer™ software
- **Available in black or white finish**

## Package Contents

The MSA12X loudspeaker package contains the following:

One (1) MSA12X loudspeaker module	One (1) 3-pin Euroblock connector
Two (2) wall/loudspeaker bracket sets	Eight (8) M6 flanged head bolts
One (1) interconnect bracket	Four (4) flat washers
One (1) yaw bracket	Four (4) double-sided washer tape rings
Three (3) power interconnect cables (region-specific)	Four (4) M6 flanged nuts
One (1) power cable	Twelve (12) zip ties
One (1) LVDS audio/control expansion cable (RJ-50)	Twelve (12) self-tapping screws
	One (1) Bose logo nameplate

Please complete and retain for your records.

Serial number: \_\_\_\_\_

Model number: \_\_\_\_\_

# Loudspeaker Dimensions

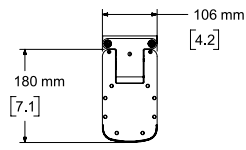

Top View

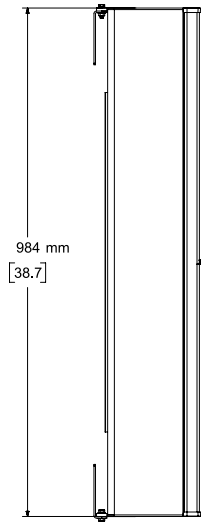

Left View



Front View

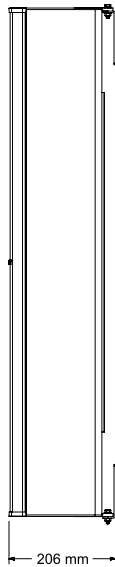

Right View

DIMENSIONS APPLY TO BOTH SIDES

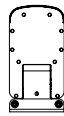

Bottom View

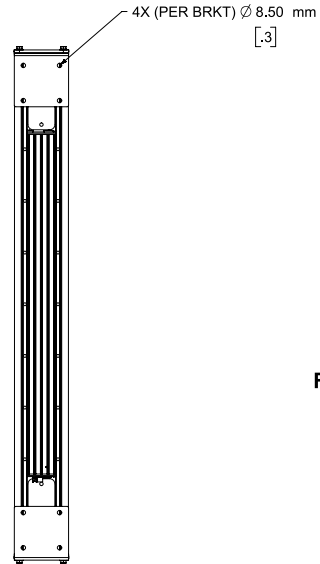

Rear View



Front View  
No Grille

- NOTES:  
1. APPROXIMATE WEIGHT IS 14.5kg [32lbs]  
2. DIMENSIONS ARE IN MILLIMETERS OVER INCHES

## Connector Panels

### Input Panel

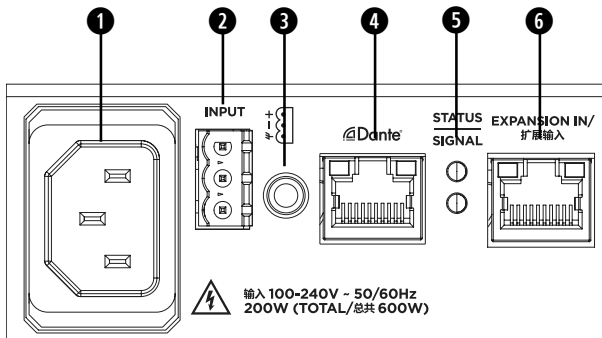

- ❶ Power connector - Use the included power cable to connect to external power, or use the power interconnect cable to connect multiple loudspeaker units. Use the power interconnect cable that is appropriate for your region.
- ❷ Analog audio connection - Connect to analog audio source using the included 3-pin Euroblock connector.
- ❸ Service Connector - For service use only. Do not insert any cables into this connector.
- ❹ Dante Input - Supports two channels of Dante® digital audio input (RJ-45).
- ❺ Network connectivity indicator lights:

LED	Function	Behavior
LED #1	Status/Fault LED	Solid green: Power on, system OK Solid or blinking red: System fault Blinking green: Identify module, firmware update
LED #2	Analog audio signal present	Green: Signal present Yellow: Limiting Red: Clipping

- ❻ Expansion connection - LVDS audio and control expansion connection (RJ-50). Use when connecting multiple MSA12X loudspeaker modules.

### Output Panel

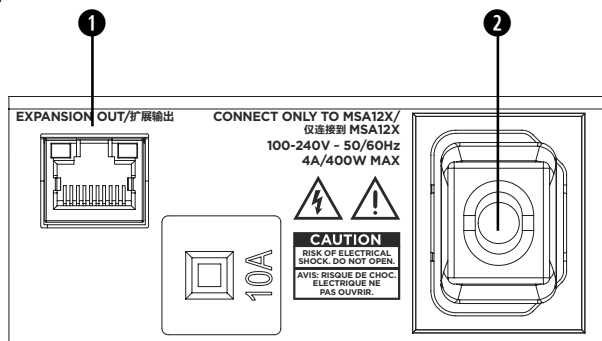

- ❶ Expansion connection - Audio and control connection (RJ-50). Use when connecting multiple MSA12X loudspeaker modules.
- ❷ Power connector - Use the included power interconnect cable to connect multiple MSA12X loudspeaker modules. Use the power interconnect cable that is appropriate for your region.

**NOTE:** The MSA12X is commonly installed with the Input Panel located at the bottom of the unit, and the Output Panel located at the top of the unit. However, the unit can be rotated 180 degrees for installation, which reverses the positions of the input and output panels. See page 20 for additional instructions when installing the unit in this position.

## Mounting Loudspeaker

The Bose MSA12X loudspeaker can be used as a single loudspeaker module, or you can use the interconnect brackets to create a larger array of up to three modules.

### Single Installer Method (Recommended)

The MSA12X is designed to be installed by a single installer, by attaching modules to the mounted wall bracket one at a time, from the top down. The top bracket alone can support the weight of three (3) MSA12X modules. After all of the modules are hanging, you can level and mark the placement of bottom bracket and complete the installation.

### Multiple Installer Method

The MSA12X can also be installed by multiple installers, by building the array on the ground and attaching the entire assembly to the mounted wall bracket. This method requires a team of installers who can lift the assembled array into position and correctly position it onto the wall bracket.

### Before You Begin - Recommended Tools

- 10 mm sockets and socket wrenches
- Torque wrench

### CAUTION:

- The loudspeaker weighs 14.5 kg (32 lbs). Use caution when lifting to avoid injury and/or damage to the speaker.
- Do not place loudspeaker resting on its grille.
- When installing the MSA12X in an alcove, leave a minimum of 0.3 m (1 ft) clearance on the top and bottom of the array.

### NOTE:

The MSA12X includes three power interconnect cables, for use when building 2- or 3-module arrays. To comply with local regulatory standards, use the cable that is appropriate for your region. Refer to the labels on each cable to determine which cable is appropriate for your region.

### Install Loudspeaker: Single Installer Method

1. Choose a mounting location that will safely support the weight of the loudspeaker. Ensure the mounting surface and the method of attaching the loudspeaker system to the surface is capable of supporting the total weight of the system. Bose recommends a safety factor of 10:1.
2. Remove packing materials and place the loudspeaker on the floor beneath the planned suspension point.
3. Attach the loudspeaker brackets and interconnect brackets (if required) to each module:
 

**NOTE:** The MSA12X is commonly installed with the input panel located at the bottom. However, it can also be installed with the input panel located at the top. For more information, see *Installing Loudspeaker in Rotated Position* on page 20.

#### For a one-loudspeaker assembly:

- a. Attach one loudspeaker bracket to each end of the loudspeaker, using the included flanged head bolts. Tighten bolts to 6.78 N-m (5 ft-lbs).

Loudspeaker Bracket

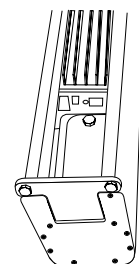
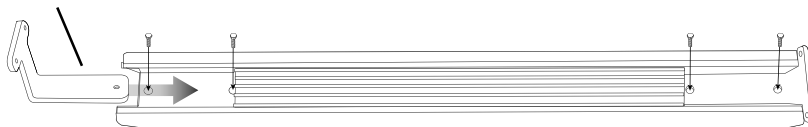

**For a two-loudspeaker assembly:**

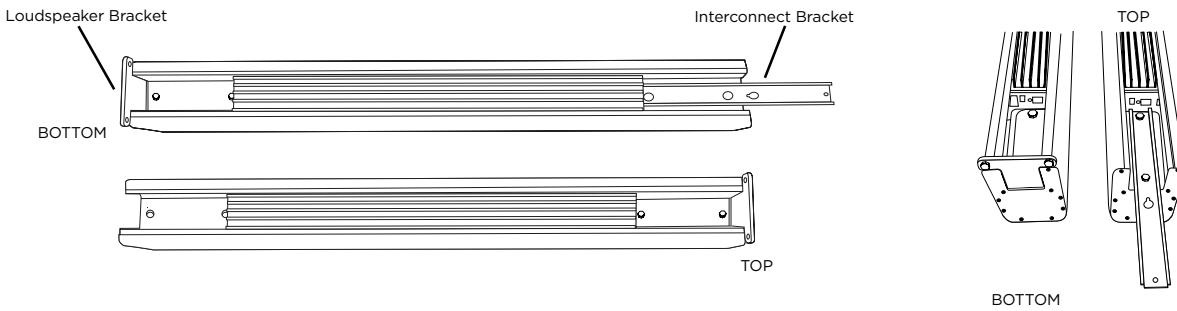

- a. Attach one loudspeaker bracket to the bottom loudspeaker module, and one loudspeaker bracket to the top loudspeaker module, using the included flanged head bolts. Tighten bolts to 6.78 N-m (5 ft-lbs).
- b. Attach one interconnect bracket to the bottom end of the top loudspeaker module, using the included flanged head bolts. Tighten the bolts to finger tightness only.
- c. Insert a flanged head bolt in the top hole of the top section on the bottom loudspeaker module. Thread the bolt at least four (4) full turns, but not so far that the flange cannot hang through the keyhole of the interconnect bracket.

**For a three-loudspeaker assembly:**

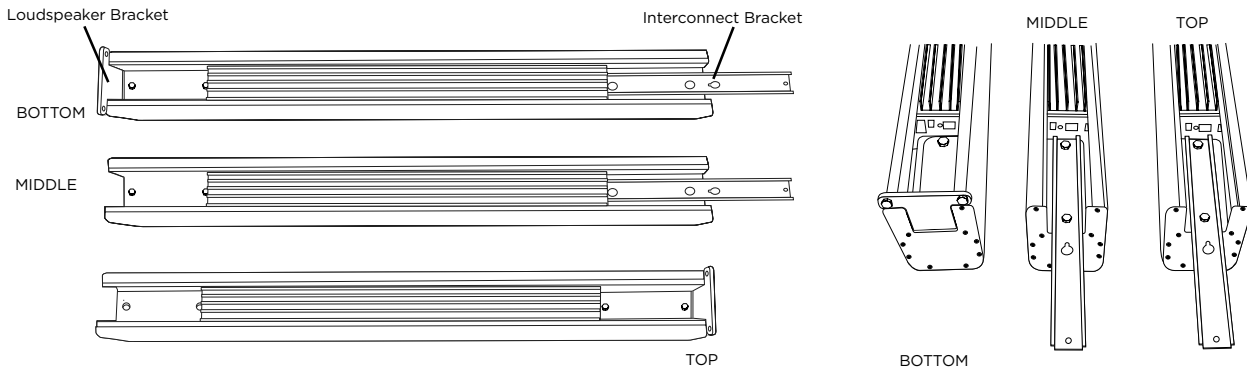

- a. Attach one loudspeaker bracket to the bottom loudspeaker module, and one loudspeaker bracket to the top module, using the included flanged head bolts. Tighten bolts to 6.78 N-m (5 ft-lbs).
- b. Attach one interconnect bracket each to the bottom of the middle and top loudspeaker modules, using the included flanged head bolts.
- c. Insert a flanged head bolt in the top hole of the top section on the bottom and middle loudspeaker modules. Thread the bolt at least four (4) full turns, but not so far that the flange cannot hang through the keyhole of the interconnect bracket.
4. Install the wall bracket on the wall where the top of the array will be located, using wall mounting screws (not included). Tighten securely. Bracket must be horizontally level. Be sure to leave sufficient clearance from the ceiling for the top of the array.

**CAUTION:** Choose a position and mounting surface that is capable of supporting the total weight of the system. Bose recommends a safety factor of 10:1.

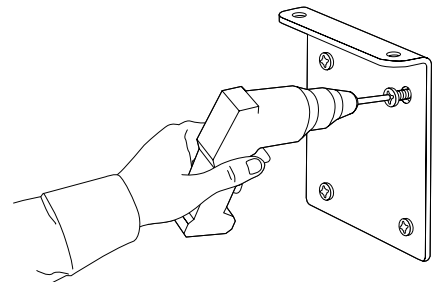

5. Thread a flanged head bolt into one side of the loudspeaker bracket on the top loudspeaker module.
6. Place a washer between the loudspeaker bracket and the wall bracket. Use the included double-sided tape ring to adhere the washer to the loudspeaker bracket around the protruding threads of the flanged head bolt.

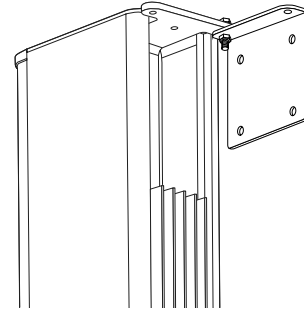
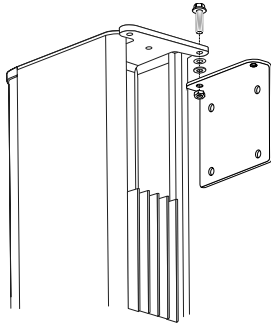

7. Lift the top module up to the wall bracket. Insert the screw into the hole at the top of the loudspeaker bracket. Thread on a flanged nut and hand-tighten securely but loosely, with the speaker turned 90 degrees.

**NOTE:** For single module installation, skip to Step 9.



8. To connect additional loudspeaker modules:

a. Using the top flanged head bolt already threaded into the top insert of the second module, hang the second module from the first module. The flanged head bolt will fit through the keyhole and hang.

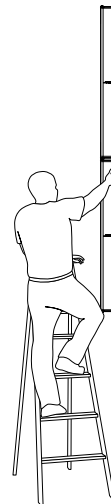
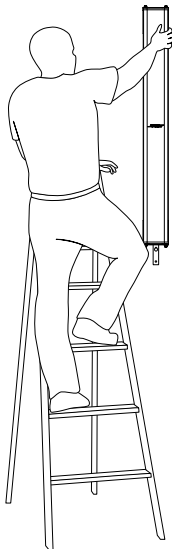



b. Push the second module up to remove the gap between the modules. Thread a flanged head bolt into the second hole, which should now be lined up between the interconnect bracket and the second module.

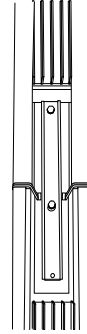
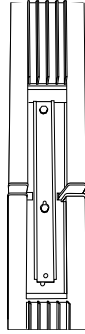

c. If you are building a three-module array, repeat steps 8a and 8b to attach the third module.

**NOTE:** For two- and three-loudspeaker assemblies, ensure that all the bolts in the unit are tightened to 6.78 N-m (5 ft-lbs), starting with the top bolt. If two loudspeaker units do not sit flush against each other, slightly loosen the four (4) bolts on the interconnect bracket connecting those two units, realign the units, and re-tighten the screws from the top down.

9. Attach a wall bracket to the loudspeaker bracket on the bottom unit, using the included flanged head bolts. Place a washer between the loudspeaker bracket and the wall bracket. Use the included double-sided tape rings to adhere the washer to the loudspeaker bracket, around the protruding threads of the flanged head bolt.
10. Use a level on the loudspeaker array to position the bottom wall bracket on the wall. Mark as needed for wall mounting screws (not included).

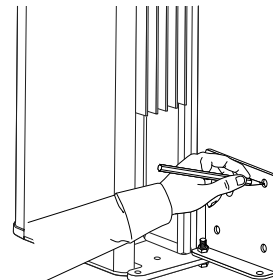
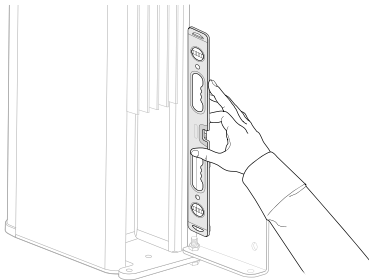

11. Mount the wall bracket to the wall, using hardware appropriate for your application.

**CAUTION:** Ensure the mounting surface and the method of attaching the loudspeaker system to the surface is capable of supporting the total weight of the system. Bose recommends a safety factor of 10:1.

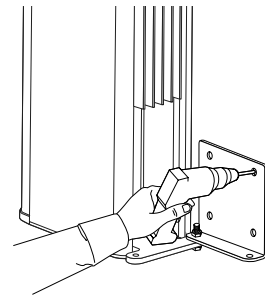

12. For two- and three-loudspeaker assemblies, connect interconnect power and audio cables between units. For more information, see Connector Panels on page 15.

13. Secure cables with the included zip ties and fasten with self-tapping screw into extrusion slot near the interconnect bracket. It is recommended to screw the zip ties close to the power cable connection to ensure that the power cable remains secure.



14. Connect field wiring and test loudspeaker operation. It is recommended to keep the loudspeaker assembly in the 90 degree orientation until loudspeaker operation has been tested, to allow easier access the connection panel and indicator lights.
15. Rotate the loudspeaker assembly into the desired position.
16. If installing the loudspeaker perpendicular to the wall, insert flanged head bolts into both holes on the bottom wall bracket, to secure the loudspeaker bracket to the wall bracket. Place washers between the loudspeaker bracket and the wall bracket.

If installing the loudspeaker at an angle that is not perpendicular to the wall, attach the yaw bracket to the loudspeaker and wall bracket to lock the speaker into position. The yaw bracket secures the loudspeaker array into position, in 6° increments (from 12° to 90°).

- a. Attach the yaw bracket to the wall bracket, using the included flanged head bolt.
- b. Attach the yaw bracket to the loudspeaker bracket, using the included flanged head bolt.

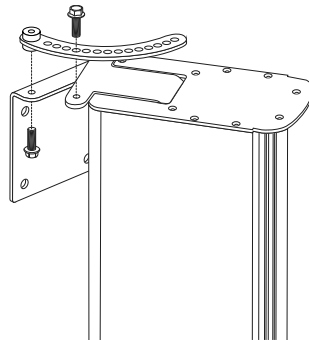

17. Tighten the flanged head bolts and flanged nuts connected to the loudspeaker brackets at the top and bottom of the array, using a torque not to exceed 6.78 N-m (5 ft-lbs).

**Install Loudspeaker: Multiple Installer Method**

1. Install the wall bracket on the wall where the top of the array will be located, using wall mounting screws (not included). Tighten securely. Bracket must be horizontally level. Be sure to leave sufficient clearance from the ceiling for the top of the array.

**CAUTION:** Choose a position and mounting surface that is capable of supporting the total weight of the system. Bose recommends a safety factor of 10:1.

2. Assemble complete array on the ground:

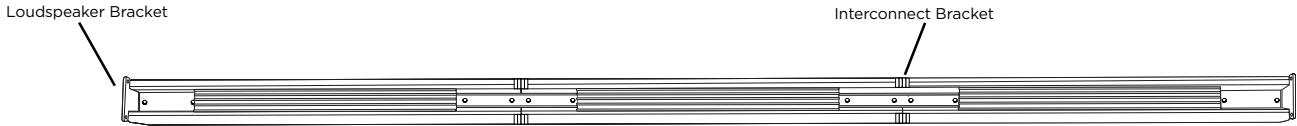

- a. For single module: Attach loudspeaker brackets to each end of the loudspeaker module, using the included flanged head bolts. Tighten bolts to 6.78 N-m (5 ft-lbs).
  - b. For 2- or 3- module array: Attach one loudspeaker bracket to the bottom loudspeaker module, and one loudspeaker bracket to the top loudspeaker module, using the included flanged head bolts. Attach one interconnect bracket between each pair of loudspeaker modules, using the included flanged head bolts. Tighten all bolts to 6.78 N-m (5 ft-lbs).
3. Thread a flanged head bolt into one side of the loudspeaker bracket on the top loudspeaker module.
  4. Place a washer between the loudspeaker bracket and the wall bracket. Use the included double-sided tape ring to adhere the washer to the loudspeaker bracket around the protruding threads of the flanged head bolt.



5. Hang complete loudspeaker array (1-3 modules) from top bracket. Ensure that the flanged head bolt attached to the loudspeaker bracket is fully inserted into the clearance hole of the wall bracket. Thread a flanged nut onto the bolt and hand-tighten securely but loosely, with the speaker turned 90 degrees.
6. Attach a wall bracket to the loudspeaker bracket on the bottom unit, using the included flanged head bolts. Place a washer between the loudspeaker bracket and the wall bracket. Use the included double-sided tape rings to adhere the washer to the loudspeaker bracket, around the protruding threads of the flanged head bolt.

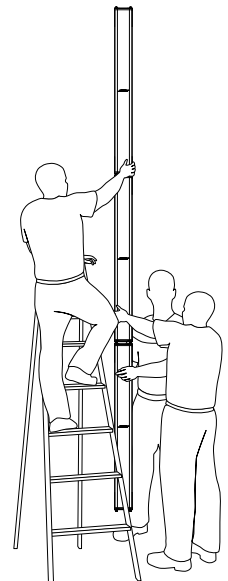

7. Use a level on the loudspeaker array to position the bottom wall bracket on the wall. Mark as needed for wall mounting screws (not included).

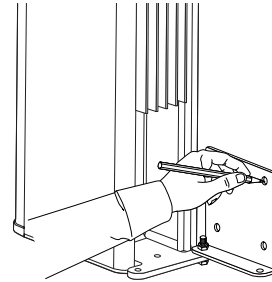
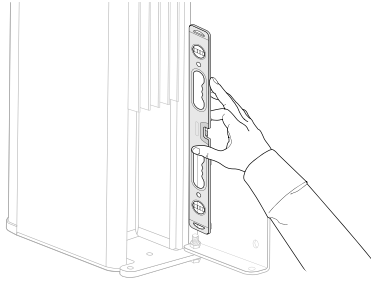

8. Mount the wall bracket to the wall, using hardware appropriate for your application.  
**CAUTION:** Ensure the mounting surface and the method of attaching the loudspeaker system to the surface is capable of supporting the total weight of the system. Bose recommends a safety factor of 10:1. Reattach MSA12X to wall brackets, including bottom screw and flanged nut.
9. For two- and three-loudspeaker assemblies, connect interconnect power and audio cables between units. For more information, see Connector Panels on page 15.
10. Secure cables with the included zip ties and fasten with self-tapping screw into extrusion slot near the interconnect bracket. It is recommended to screw the zip ties close to the power cable connection to ensure that the power cable remains secure.

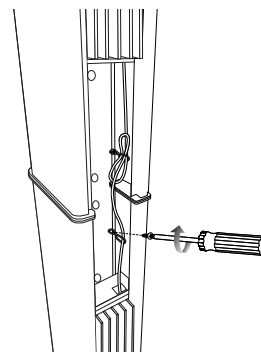
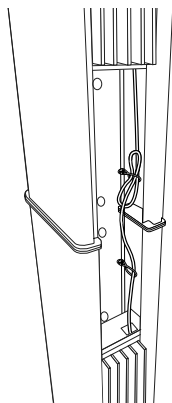

11. Connect field wiring and test loudspeaker operation. It is recommended to keep the loudspeaker assembly in the 90 degree orientation until loudspeaker operation has been tested, to allow easier access the connection panel and indicator lights.
12. Rotate the loudspeaker assembly into the desired position.
13. If installing the loudspeaker perpendicular to the wall, insert flanged head bolts into both holes on the bottom wall bracket, to secure the loudspeaker bracket to the wall bracket. Place washers between the loudspeaker bracket and the wall bracket.

If installing the loudspeaker at an angle that is not perpendicular to the wall, attach the yaw bracket to the loudspeaker and wall bracket to lock the speaker into position. The yaw bracket secures the loudspeaker array into position, in 6° increments (from 12° to 90°).

- a. Attach the yaw bracket to the wall bracket, using a flanged head bolt.
  - b. Attach the yaw bracket to the loudspeaker bracket, using a flanged hex bolt.
14. Tighten the flanged head bolts and flanged nuts connected to the loudspeaker brackets at the top and bottom of the array, using a torque not to exceed 6.78 N-m (5 ft-lbs).

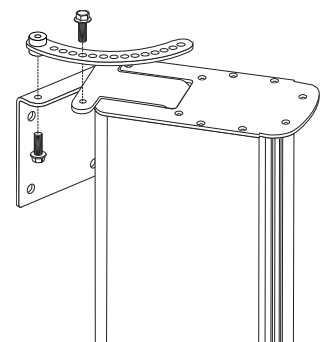

## Using a Safety Cable

Some regional construction codes require the use of a secondary method of securing loudspeakers to support structures to provide additional safety. Bose recommends using a safety cable, even if one is not required. Follow the safety cable manufacturer's instructions. Choose a mounting position, method, and hardware consistent with local building codes and regulations.

The MSA12X provides two options for connecting a safety cable:

- Connect a safety cable using the 7mm (0.28 in) hole in the loudspeaker bracket, either directly or using an M6 eye bolt and nut (not included), tightened to 6.78 N-m (5 ft-lbs).
- Connect a safety cable directly to the MSA12X using the 10 mm (0.39 in) hole in the interconnect bracket.

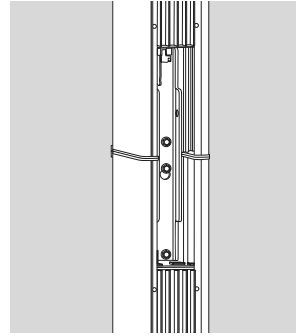
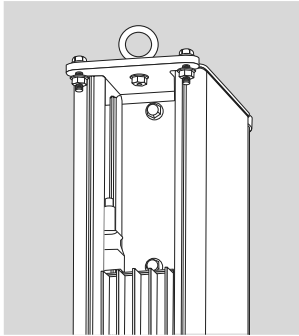

**CAUTION:** If you are unfamiliar with the proper design, use, and purpose of a safety cable, consult a licensed professional engineer or a rigging professional.

## Installing Loudspeaker in Rotated Position

The MSA12X can be rotated 180 degrees for installation. This reverses the position of the input and output connection panels.

To install a MSA12X unit or 2- or 3-loudspeaker assembly in the reverse position, follow the general instructions for Mounting Loudspeaker beginning on page 16. In addition:

1. Remove the Bose logo that comes pre-installed on the loudspeaker and discard. Attach the extra logo included in the package in the new position.
2. Specify the reverse speaker orientation using Bose ControlSpace Designer software. Change from bottom to top configuration in the Advanced window. For more information, see the help system located in the ControlSpace Designer software.

## Recommended Amplifier and Signal Processing

System designs that have any of the following requirements require use of a Bose ESP engineered sound processor

- Adding Room EQ in addition to on-board Loudspeaker EQ
- Independent EQ/ gain control for each beam when using dual beams (requires Dante card in ESP)
- Recalling beam steering preset using hardware controllers or CSR remote (requires Dante card in ESP)
- Parameter Set Control of typical Functions (Gain, Mute, Input Type) using hardware controllers or CSR remote (requires Dante card in ESP)

## Recommended DSP and Control hardware

### DSP

- ControlSpace® ESP-880, ControlSpace® ESP-1240, ControlSpace® ESP-1600, ControlSpace® ESP-4120
- ControlSpace EX-1280C

### Control (Requires ControlSpace® ESP product)

- ControlSpace® CC-64, CC-1, CC-2, CC-3, CC-1 and ControlSpace® Remote App

## System Setup

To use the MSA12X, download and install the latest version of ControlSpace Designer software. Visit **pro.Bose.com** to download the latest software version, which includes product firmware, the latest algorithms, and a detailed help system that guides system designers and installers through configuring the MSA12X for use in high-quality audio systems.

With a network connection in place and ControlSpace Designer software installed, use the Update Firmware tool inside ControlSpace Designer software to scan and update the MSA12X. Once the status reads “Up-to-Date” in the firmware panel, proceed with your system design using ControlSpace Designer software. For full details on using ControlSpace Designer software to configure, control, and monitor the ESP processor or entire systems built with Bose networked system electronics, visit **pro.Bose.com** and download the ControlSpace Software Guide or use the help system inside the software.

## Additional Information

Refer to **pro.Bose.com** for more information about your product (including accessories and replacement parts).

Dante® is a registered trademark of Audinate Pty Ltd.

### Limited Warranty

Your product is covered by a limited warranty. Visit **pro.Bose.com** for warranty details.

The warranty information provided with this product does not apply in Australia and New Zealand. See our website at **www.bose.com/au/warranty** or **www.bose.com/nz/warranty** for details of the Australian and New Zealand warranty.

### Date of Manufacture

The eighth digit in the serial number indicates the year of manufacture; “7” is 2007 or 2017.

## MSA12X Loudspeaker Technical Specifications

Single Module Performance			
Frequency Response (-3 dB) <sup>(1)</sup>	75 Hz - 17 kHz		
Frequency Range (-10 dB) <sup>(1)</sup>	58 Hz - 18 kHz		
Horizontal Dispersion <sup>(2)</sup>	160°		
Vertical Opening Angles	Software Adjustable: 1 module: up to 30°; 2-3 modules: up to 40° Vertical		
Vertical Beam Steering Angles	± 20°		
Multiple Module Performance	1-Module	2-Modules	3-Modules
Typical Usable Throw Distance <sup>(4)</sup>	10 m (33 ft)	25 m (82 ft)	35 m (115 ft)
Distance	10 m (33 ft)	20 m (66 ft)	30 m (98 ft)
Maximum SPL <sup>(3)</sup> at Distance	97 dB (103 dB Peak)	96 dB (102 dB Peak)	95 dB (101 dB Peak)
Low-frequency Beam Control Limit	500 Hz	250 Hz	160 Hz
Driver Complement, Full-range Cones	12 x 57 mm (2.25 in)	24 x 57 mm (2.25 in)	36 x 57 mm (2.25 in)
Amplifier Channels / Rated Power	12 x 50 W	24 x 50 W	36 x 50 W
Physical Array Height	1 m (39 in)	2 m (78 in)	3 m (117 in)
Electrical Performance (Single Module)			
AC Mains Voltage	Universal 85/264 VAC/50/60 Hz		
AC Mains Connector	IEC60320-C14		
AC Power Consumption	120 VAC / 240 VAC: 25 W (idle), 275 W (max)		
Audio Inputs			
Analog Audio Input Connector	3-pin Phoenix connector <sup>(5)</sup>		
Analog Audio Maximum Input Level	0 dBu / +10 dBu / +24 dBu (pad engaged)		
Input Sensitivity	15 dBu		
Input Impedance	20k Ω		
Digital Audio Inputs	Input: 2 channels of Dante® digital audio network (RJ-45); Expansion: LVDS (RJ-50)		
Digital Output	Expansion: LVDS (RJ-50)		
Integrated DSP			
DSP Platform / Network Support	Bose ControlSpace®		
A/D and D/A Converters	24-bit, 48 kHz		
Number of Beams Supported <sup>(5)</sup>	2		
FIR Filter Support (Local MSA12X)	1024 tap @ 48 kHz		
Number User Presets (Local MSA12X)	10		
Audio Latency	5.7 ms		
Physical			
Enclosure	Extruded aluminum sidewalls; steel end caps, all powder coated		
Grille	Powder-coated aluminum		
Indicators and Controls	Power, limit, fault		
Operating Temperature Range (Ambient)	0 °C to 40 °C / 32 °F to 104 °F		
Cooling System	Cooling is passive only, airflow bottom to top		
Environmental	Indoor only		
Suspension / Mounting	Integrated wall brackets; allows horizontal yaw up to 90° in either direction		
Dimensions (H x W x D)	984 x 106 x 206 mm (38.74 x 4.16 x 8.12 in)		
Net Weight	14.5 kg (32 lbs)		
Shipping Weight	19.2 kg (42.3 lbs)		
Included Accessories	(1) Power cord, (1) Power interconnect cable, (1) RJ-50 expansion cable, (1) Phoenix connector, (2) Wall/Speaker-mount bracket sets, (1) Interconnect bracket, (12) Zip ties, (1) Bose logo, (4) M6 flange nuts, (8) M6 hex head bolts, (1) yaw bracket		
Product Codes			
Black (RAL 9005)	[787856] - 1110,2110,3110,4110,5110	US, EU, JP, UK, AU	
White (RAL 9010)	[787856] - 1210,2210,3210,4210,5210	US, EU, JP, UK, AU	

## Footnotes

- (1) Frequency response and range measured at 1 m, on-axis with recommended active EQ in anechoic environment  
(2) 1-4k average, -6 dB  
(3) Max SPL calculated based on free-field (no boundary loading gain) sensitivity, exclusive of power compression, and without beam steering, spreading or smoothing functions applied  
(4) Typical Maximum Usable Throw Distance includes considerations for reverberation and speech intelligibility  
(5) Analog audio input is limited to one (1) beam; two (2) beam support requires Dante input

## Contact Information

Visit us on the web at [pro.Bose.com](http://pro.Bose.com).

### Americas

(USA, Canada, Mexico, Central America, South America)  
Bose Corporation  
Framingham, MA 01701 USA  
Corporate Center: 508-879-7330  
Americas Professional Systems,  
Technical Support: 800-994-2673

### Australia

Bose Pty Limited  
Unit 3/2 Holker Street  
Newington NSW Australia  
61 2 8737 9999

### Belgium

Bose N.V. / S.A  
Limesweg 2, 03700  
Tongeren, Belgium  
012-390800

### China

Bose Electronics (Shanghai) Co Ltd  
25F, L'Avenue  
99 Xianxia Road  
Shanghai, P.R.C. 200051 China  
86 21 6010 3800

### France

Bose S.A.S  
26-28 avenue de Winchester  
78100 St. Germain en Laye, France  
01-30-61-63-63

### Germany

Bose GmbH  
Max-Planck Strasse 36D 61381  
Friedrichsdorf, Deutschland  
06172-7104-0

### Hong Kong

Bose Limited  
Suites 2101-2105, Tower One, Times Square  
1 Matheson Street, Causeway Bay, Hong Kong  
852 2123 9000

### India

Bose Corporation India Private Limited  
Salcon Aurum, 3rd Floor  
Plot No. 4, Jasola District Centre  
New Delhi - 110025, India  
91 11 43080200

### Italy

Bose SpA  
Centro Leoni A - Via G. Spadolini  
5 20122 Milano, Italy  
39-02-36704500

### Japan

Bose G.K.  
ARK Hills South Tower 13F  
1-4-5 Roppongi, Minato-ku, Tokyo, 106-0032, Japan  
0570-080-021  
[www.bose.co.jp](http://www.bose.co.jp)

### The Netherlands

Bose B.V.  
Gorslaan 60  
1441 RG Purmerend  
The Netherlands  
0299-390139

### United Kingdom

Bose Ltd  
1 Ambley Green, Gillingham Business Park  
KENT ME8 0NJ  
Gillingham, England  
0870-741-4500

See website for other countries

## Importer Information

### European Union

Bose Products B.V., Gorslaan 60, 1441 RG Purmerend, The Netherlands

### China

Bose Electronics (Shanghai) Company Limited, Part C, Plan 9, No. 353 North Riying Road, China (Shanghai) Pilot Free Trade Zone

### Taiwan

Bose Taiwan Branch, 9F-A1, No. 10, Section 3, Minsheng East Road, Taipei City 104, Taiwan  
Tel: +886-2-2514 7676

### Mexico

Bose de México, S. de R.L. de C.V., Paseo de las Palmas 405-204, Lomas de Chapultepec, 11000 México, D.F.  
Tel: +5255 (5202) 3545





796790-0010

©2018 Bose Corporation, All rights reserved.  
Framingham, MA 01701-9168 USA  
[www.pro.Bose.com](http://www.pro.Bose.com)  
All trademarks are the property of their respective owners  
AM796790 Rev. 01  
January 2018

