

DENON

DOUBLE CD/MP3 PLAYER

DN-D4500

OPERATING INSTRUCTIONS

IMPORTANT TO SAFETY

WARNING:

TO PREVENT FIRE OR SHOCK HAZARD, DO NOT EXPOSE THIS APPLIANCE TO RAIN OR MOISTURE.

CAUTION

1. Handle the power supply cord carefully

Do not damage or deform the power supply cord. If it is damaged or deformed, it may cause electric shock or malfunction when used. When removing from wall outlet, be sure to remove by holding the plug attachment and not by pulling the cord.

2. Do not open the rear cover

In order to prevent electric shock, do not open the top cover.

If problems occur, contact your DENON DEALER.

3. Do not place anything inside

Do not place metal objects or spill liquid inside the system.

Electric shock or malfunction may result.

Please, record and retain the Model name and serial number of your set shown on the rating label.

Model No. DN-D4500

Serial No. _____



CAUTION
RISK OF ELECTRIC SHOCK
DO NOT OPEN



CAUTION:

TO REDUCE THE RISK OF ELECTRIC SHOCK, DO NOT REMOVE COVER (OR BACK). NO USER-SERVICEABLE PARTS INSIDE. REFER SERVICING TO QUALIFIED SERVICE PERSONNEL.

The lightning flash with arrowhead symbol, within an equilateral triangle, is intended to alert the user to the presence of uninsulated "dangerous voltage" within the product's enclosure that may be of sufficient magnitude to constitute a risk of electric shock to persons.



The exclamation point within an equilateral triangle is intended to alert the user to the presence of important operating and maintenance (servicing) instructions in the literature accompanying the appliance.



NOTE:

This CD player uses the semiconductor laser. To allow you to enjoy music at a stable operation, it is recommended to use this in a room of 5°C (41°F) ~ 35°C (95°F).

LABELS (for U.S.A. model only)

CERTIFICATION

THIS PRODUCT COMPLIES WITH DHHS RULES 21 CFR SUBCHAPTER J APPLICABLE AT DATE OF MANUFACTURE.

CAUTION:

USE OF CONTROLS OR ADJUSTMENTS OR REFORMATION OF PROCEDURES OTHER THAN THOSE SPECIFIED HEREIN MAY RESULT IN HAZARDOUS RADIATION EXPOSURE.

THE COMPACT DISC PLAYER SHOULD NOT BE ADJUSTED OR REPAIRED BY ANYONE EXCEPT PROPERLY QUALIFIED SERVICE PERSONNEL.

This device complies with Part 15 of the FCC Rules. Operation is subject to the following two conditions: (1) This device may not cause harmful interference, and (2) this device must accept any interference received, including interference that may cause undesired operation.

This Class B digital apparatus meets all requirements of the Canadian Interference-Causing Equipment Regulations.

Cet appareil numérique de la classe B respecte toutes les exigences du Règlement sur le matériel brouilleur du Canada.

• FOR CANADA MODEL ONLY

CAUTION

TO PREVENT ELECTRIC SHOCK, MATCH WIDE BLADE OF PLUG TO WIDE SLOT, FULLY INSERT.

• POUR LES MODELE CANADIENS UNIQUEMENT

ATTENTION

POUR ÉVITER LES CHOCS ÉLECTRIQUES, INTRODUIRE LA LAME LA PLUS LARGE DE LA FICHE DANS LA BORNE CORRESPONDANTE DE LA PRISE ET POUSSER JUSQU' AU FOND.

SAFETY INSTRUCTIONS

1. Read Instructions – All the safety and operating instructions should be read before the product is operated.
2. Retain Instructions – The safety and operating instructions should be retained for future reference.
3. Heed Warnings – All warnings on the product and in the operating instructions should be adhered to.
4. Follow Instructions – All operating and use instructions should be followed.
5. Cleaning – Unplug this product from the wall outlet before cleaning. Do not use liquid cleaners or aerosol cleaners.
6. Attachments – Do not use attachments not recommended by the product manufacturer as they may cause hazards.
7. Water and Moisture – Do not use this product near water – for example, near a bath tub, wash bowl, kitchen sink, or laundry tub; in a wet basement; or near a swimming pool; and the like.
8. Accessories – Do not place this product on an unstable cart, stand, tripod, bracket, or table. The product may fall, causing serious injury to a child or adult, and serious damage to the product. Use only with a cart, stand, tripod, bracket, or table recommended by the manufacturer, or sold with the product. Any mounting of the product should follow the manufacturer's instructions, and should use a mounting accessory recommended by the manufacturer.
9. A product and cart combination should be moved with care. Quick stops, excessive force, and uneven surfaces may cause the product and cart combination to overturn.
10. Ventilation – Slots and openings in the cabinet are provided for ventilation and to ensure reliable operation of the product and to protect it from overheating, and these openings must not be blocked or covered. The openings should never be blocked by placing the product on a bed, sofa, rug, or other similar surface. This product should not be placed in a built-in installation such as a bookcase or rack unless proper ventilation is provided or the manufacturer's instructions have been adhered to.
11. Power Sources – This product should be operated only from the type of power source indicated on the marking label. If you are not sure of the type of power supply to your home, consult your product dealer or local power company. For products intended to operate from battery power, or other sources, refer to the operating instructions.
12. Grounding or Polarization – This product may be equipped with a polarized alternating-current line plug (a plug having one blade wider than the other). This plug will fit into the power outlet only one way. This is a safety feature. If you are unable to insert the plug fully into the outlet, try reversing the plug. If the plug should still fail to fit, contact your electrician to replace your obsolete outlet. Do not defeat the safety purpose of the polarized plug.



13. Power-Cord Protection – Power-supply cords should be routed so that they are not likely to be walked on or pinched by items placed upon or against them, paying particular attention to cords at plugs, convenience receptacles, and the point where they exit from the product.
15. Outdoor Antenna Grounding – If an outside antenna or cable system is connected to the product, be sure the antenna or cable system is grounded so as to provide some protection against voltage surges and built-up static charges. Article 810 of the National Electrical Code, ANSI/NFPA 70, provides information with regard to proper grounding of the mast and supporting structure, grounding of the lead-in wire to an antenna discharge unit, size of grounding conductors, location of antenna-discharge unit, connection to grounding electrodes, and requirements for the grounding electrode. See Figure A.
16. Lightning – For added protection for this product during a lightning storm, or when it is left unattended and unused for long periods of time, unplug it from the wall outlet and disconnect the antenna or cable system. This will prevent damage to the product due to lightning and power-line surges.
17. Power Lines – An outside antenna system should not be located in the vicinity of overhead power lines or other electric light or power circuits, or where it can fall into such power lines or circuits. When installing an outside antenna system, extreme care should be taken to keep from touching such power lines or circuits as contact with them might be fatal.
18. Overloading – Do not overload wall outlets, extension cords, or integral convenience receptacles as this can result in a risk of fire or electric shock.
19. Object and Liquid Entry – Never push objects of any kind into this product through openings as they may touch dangerous voltage points or short-out parts that could result in a fire or electric shock. Never spill liquid of any kind on the product.
20. Servicing – Do not attempt to service this product yourself as opening or removing covers may expose you to dangerous voltage or other hazards. Refer all servicing to qualified service personnel.
21. Damage Requiring Service – Unplug this product from the wall outlet and refer servicing to qualified service personnel under the following conditions:
 - a) When the power-supply cord or plug is damaged,
 - b) If liquid has been spilled, or objects have fallen into the product,
 - c) If the product has been exposed to rain or water,
 - d) If the product does not operate normally by following the operating instructions. Adjust only those controls that are covered by the operating instructions as an improper adjustment of other controls may result in damage and will often require extensive work by a qualified technician to restore the product to its normal operation,
 - e) If the product has been dropped or damaged in any way, and
 - f) When the product exhibits a distinct change in performance – this indicates a need for service.
22. Replacement Parts – When replacement parts are required, be sure the service technician has used replacement parts specified by the manufacturer or have the same characteristics as the original part. Unauthorized substitutions may result in fire, electric shock, or other hazards.
23. Safety Check – Upon completion of any service or repairs to this product, ask the service technician to perform safety checks to determine that the product is in proper operating condition.
24. Wall or Ceiling Mounting – The product should be mounted to a wall or ceiling only as recommended by the manufacturer.
25. Heat – The product should be situated away from heat sources such as radiators, heat registers, stoves, or other products (including amplifiers) that produce heat.

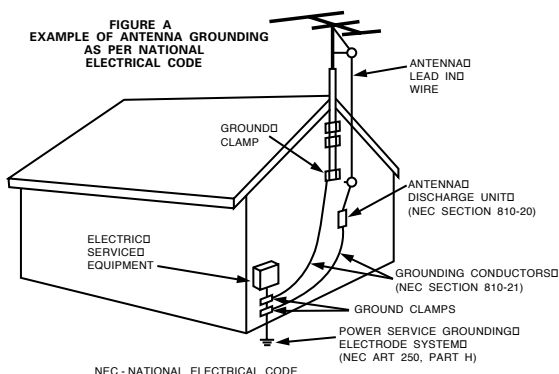

NOTE ON USE

 <ul style="list-style-type: none"> • Avoid high temperatures. Allow for sufficient heat dispersion when installed in a rack. • Vermeiden Sie hohe Temperaturen. Beachten Sie, daß eine ausreichend Luftzirkulation gewährleistet wird, wenn das Gerät auf ein Regal gestellt wird. • Eviter des températures élevées. Tenir compte d'une dispersion de chaleur suffisante lors de l'installation sur une étagère. • Evitate di esporre l'unità a temperature alte. Assicuratevi che ci sia un'adeguata dispersione del calore quando installate l'unità in un mobile per componenti audio. • Evite altas temperaturas. Permite la suficiente dispersión del calor cuando está instalado en la consola. • Vermijd hoge temperaturen. Zorg voor een degelijk hitteafvoer indien het apparaat op een rek wordt geplaatst. • Undvik höga temperaturer. Se till att det finns möjlighet till god värmeavledning vid montering i ett rack. 	 <ul style="list-style-type: none"> • Keep the apparatus free from moisture, water, and dust. • Halten Sie das Gerät von Feuchtigkeit, Wasser und Staub fern. • Protéger l'appareil contre l'humidité, l'eau et lapoussière. • Tenete l'unità lontana dall'umidità, dall'acqua e dalla polvere. • Mantenga el equipo libre de humedad, agua y polvo. • Laat geen vochtigheid, water of stof in het apparaat binnendringen. • Utsätt inte apparaten för fukt, vatten och damm. 	 <ul style="list-style-type: none"> • Do not let foreign objects into the apparatus. • Keine fremden Gegenstände in das Gerät kommen lassen. • Ne pas laisser des objets étrangers dans l'appareil. • E' importante che nessun oggetto è inserito all'interno dell'unità. • No deje objetos extraños dentro del equipo. • Laat geen vreemde voorwerpen in dit apparaat vallen. • Se till att främmande föremål inte tränger in i apparaten.
 <ul style="list-style-type: none"> • Handle the power cord carefully. Hold the plug when unplugging the cord. • Gehen Sie vorsichtig mit dem Netzkabel um. Halten Sie das Kabel am Stecker, wenn Sie den Stecker herausziehen. • Manipuler le cordon d'alimentation avec précaution. Tenir la prise lors du débranchement du cordon. • Maneggiare il filo di alimentazione con cura. Agite per la spina quando scollegate il cavo dalla presa. • Maneje el cordón de energía con cuidado. Sostenga el enchufe cuando desconecte el cordón de energía. • Hanteer het netsnoer voorzichtig. Houd het snoer bij de stekker vast wanneer deze moet worden aan- of losgekoppeld. • Hantera nätkabeln varsamt. Håll i kabeln när den kopplas från el-uttaget. 	 <ul style="list-style-type: none"> • Unplug the power cord when not using the apparatus for long periods of time. • Wenn das Gerät eine längere Zeit nicht verwendet werden soll, trennen Sie das Netzkabel vom Netzstecker. • Débrancher le cordon d'alimentation lorsque l'appareil n'est pas utilisé pendant de longues périodes. • Disinnestate il filo di alimentazione quando avete l'intenzione di non usare il filo di alimentazione per un lungo periodo di tempo. • Desconecte el cordón de energía cuando no utilice el equipo por mucho tiempo. • Neem altijd het netsnoer uit het stopcontact wanneer het apparaat gedurende een lange periode niet wordt gebruikt. • Koppla ur nätkabeln om apparaten inte kommer att användas i lång tid. 	 <ul style="list-style-type: none"> • Do not let insecticides, benzene, and thinner come in contact with the apparatus. • Lassen Sie das Gerät nicht mit Insektiziden, Benzin oder Verdünnungsmitteln in Berührung kommen. • Ne pas mettre en contact des insecticides, du benzène et un diluant avec l'appareil. • Assicuratevvi che l'unità non venga in contatto con insetticidi, benzolo o solventi. • No permita el contacto de insecticidas, gasolina y diluyentes con el equipo. • Laat geen insektenverdelgende middelen, benzine of verfdunner met dit apparaat in kontakt komen. • Se till att inte insektsmedel på spraybruk, bensen och thinner kommer i kontakt med apparatens hölje.
 <ul style="list-style-type: none"> • Never disassemble or modify the apparatus in any way. • Versuchen Sie niemals das Gerät auseinander zu nehmen oder auf jegliche Art zu verändern. • Ne jamais démonter ou modifier l'appareil d'une manière ou d'une autre. • Non smontate mai, nè modificate l'unità in nessun modo. • Nunca desarme o modifique el equipo de ninguna manera. • Nooit dit apparaat demonteren of op andere wijze modiëren. • Ta inte isär apparaten och försök inte bygga om den. 	 <p>* (For apparatuses with ventilation holes)</p> <ul style="list-style-type: none"> • Do not obstruct the ventilation holes. • Die Belüftungsöffnungen dürfen nicht verdeckt werden. • Ne pas obstruer les trous d'aération. • Non coprite i fori di ventilazione. • No obstruya los orificios de ventilación. • De ventilatieopeningen mogen niet worden geblokkeerd. • Täpp inte till ventilationsöppningarna. 	 <ul style="list-style-type: none"> • Never disassemble or modify the apparatus in any way. • Versuchen Sie niemals das Gerät auseinander zu nehmen oder auf jegliche Art zu verändern. • Ne jamais démonter ou modifier l'appareil d'une manière ou d'une autre. • Non smontate mai, nè modificate l'unità in nessun modo. • Nunca desarme o modifique el equipo de ninguna manera. • Nooit dit apparaat demonteren of op andere wijze modiëren. • Ta inte isär apparaten och försök inte bygga om den.

CAUTION

- Minimum distances around the apparatus for sufficient ventilation.
- The ventilation should not be impeded by covering the ventilation openings with items, such as newspapers, table-cloths, curtains, etc..
- No naked flame sources, such as lighted candles, should be placed on the apparatus.
- Attention should be drawn to the environmental aspects of battery disposal.
- The use of apparatus in tropical and/or moderate climates.

• **DECLARATION OF CONFORMITY**

We declare under our sole responsibility that this product, to which this declaration relates, is in conformity with the following standards: EN60065, EN55013, EN55020, EN61000-3-2 and EN61000-3-3.
Following the provisions of 73/23/EEC, 89/336/EEC and 93/68/EEC Directive.

• **ÜBEREINSTIMMUNGSERKLÄRUNG**

Wir erklären unter unserer Verantwortung, daß dieses Produkt, auf das sich diese Erklärung bezieht, den folgenden Standards entspricht: EN60065, EN55013, EN55020, EN61000-3-2 und EN61000-3-3.
Entspricht den Verordnungen der Direktive 73/23/EEC, 89/336/EEC und 93/68/EEC.

• **DECLARATION DE CONFORMITE**

Nous déclarons sous notre seule responsabilité que l'appareil, auquel se réfère cette déclaration, est conforme aux standards suivants: EN60065, EN55013, EN55020, EN61000-3-2 et EN61000-3-3.
D'après les dispositions de la Directive 73/23/EEC, 89/336/EEC et 93/68/EEC.

• **DICHIARAZIONE DI CONFORMITÀ**

Dichiariamo con piena responsabilità che questo prodotto, al quale la nostra dichiarazione si riferisce, è conforme alle seguenti normative: EN60065, EN55013, EN55020, EN61000-3-2 e EN61000-3-3.
In conformità con le condizioni delle direttive 73/23/EEC, 89/336/EEC e 93/68/EEC.
QUESTO PRODOTTO E' CONFORME
AL D.M. 28/08/95 N. 548

• **DECLARACIÓN DE CONFORMIDAD**

Declaramos bajo nuestra exclusiva responsabilidad que este producto al que hace referencia esta declaración, está conforme con los siguientes estándares: EN60065, EN55013, EN55020, EN61000-3-2 y EN61000-3-3.
Siguiendo las provisiones de las Directivas 73/23/EEC, 89/336/EEC y 93/68/EEC.

• **EENVORMIGHEIDSVERKLARING**

Wij verklaren uitsluitend op onze verantwoordelijkheid dat dit produkt, waarop deze verklaring betrekking heeft, in overeenstemming is met de volgende normen: EN60065, EN55013, EN55020, EN61000-3-2 en EN61000-3-3.
Volgens de bepalingen van de Richtlijnen 73/23/EEC, 89/336/EEC en 93/68/EEC.

• **ÖVERENSSTÄMMELSESINTYG**

Härmed intygas helt på eget ansvar att denna produkt, vilken detta intyg avser, uppfyller följande standarder: EN60065, EN55013, EN55020, EN61000-3-2 och EN61000-3-3.
Enligt stadgarna i direktiv 73/23/EEC, 89/336/EEC och 93/68/EEC.

CLASS 1 LASER PRODUCT
LUOKAN 1 LASERLAITE
KLASS 1 LASERAPPARAT

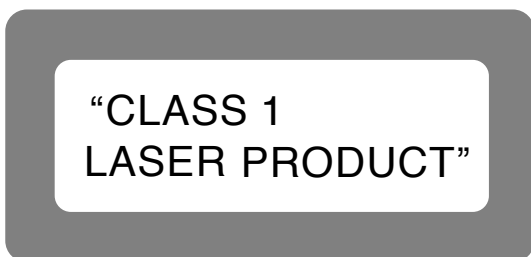

- ADVARSEL:** USYNLIG LASERSTRÅLING VED ÅBNING, NÅR SIKKERHEDSAFBRYDERE ER UDE AF FUNKTION. UNDGÅ UDSAETTELSE FOR STRÅLING.
- VAROITUS!** LAITTEEN KÄYTTÄMINEN MUULLA KUIN TÄSSÄ KÄYTTÖOHJEESSA MAINITULLA TAVALLA SAATTAA ALTISTAA KÄYTTÄJÄN TURVALLISUUSLUOKAN 1 YLITTÄVÄLLE NÄKYMÄMTTÖMÄLLE LASERSÄTEILYLLE.
- VARNING-** OM APPARATEN ANVÄNDS PÅ ANNAT SÄTT ÄN I DENNA BRUKSANVISNING SPECIFICERATS, KAN ANVÄNDAREN UTSÄTTAS FÖR OSYNLIG LASERSTRÅLNING SOM ÖVERSKRIDER GRÄNSEN FÖR LASERKLASS 1.

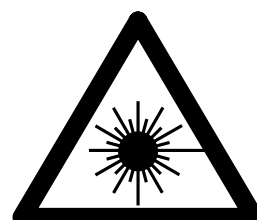

A NOTE ABOUT RECYCLING:

This product's packaging materials are recyclable and can be reused. Please dispose of any materials in accordance with the local recycling regulations.

When discarding the unit, comply with local rules or regulations.

Batteries should never be thrown away or incinerated but disposed of in accordance with the local regulations concerning chemical waste.

This product and the accessories packed together constitute the applicable product according to the WEEE directive except batteries.

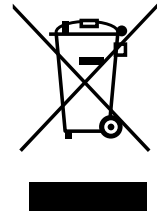
**HINWEIS ZUM RECYCLING:**

Das Verpackungsmaterial dieses Produktes ist für zum Recyceln geeignet und kann wieder verwendet werden. Bitte entsorgen Sie alle Materialien entsprechend der örtlichen Recycling-Vorschriften.

Beachten Sie bei der Entsorgung des Gerätes die örtlichen Vorschriften und Bestimmungen.

Die Batterien dürfen nicht in den Hausmüll geworfen oder verbrannt werden; bitte geben Sie die Batterien gemäß örtlichen Bestimmungen an den Sammelstellen oder Sondermüllplätzen ab.

Dieses Produkt zusammen mit den Zubehörteilen ist das geltende Produkt der WEEE-Direktive, davon ausgenommen sind die Batterien.

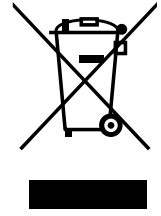
**UNE REMARQUE CONCERNANT LE RECYCLAGE:**

Les matériaux d'emballage de ce produit sont recyclables et peuvent être réutilisés. Veuillez disposer de tout matériau conformément aux règlements de recyclage locaux.

Lorsque vous mettez cet appareil au rebut, respectez les lois ou réglementations locales.

Les piles ne doivent jamais être jetées ou incinérées, mais mises au rebut conformément aux règlements locaux concernant les déchets chimiques.

Ce produit et les accessoires emballés ensemble sont des produits conformes à la directive DEEE sauf pour les piles.

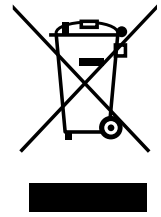
**NOTA RELATIVA AL RICICLAGGIO:**

I materiali di imballaggio di questo prodotto sono riutilizzabili e riciclabili. Smaltire i materiali conformemente alle normative locali sul riciclaggio.

Per smaltire l'unità, osservare la normativa in vigore nel luogo di utilizzo.

Non gettare le batterie, né incenerirle, ma smaltirle conformemente alla normativa locale sui rifiuti chimici.

Questo prodotto e gli accessori inclusi nell'imballaggio sono applicabili alla direttiva RAEE, ad eccezione delle batterie.

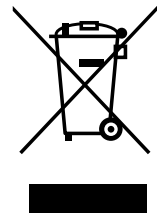
**ACERCA DEL RECICLAJE:**

Los materiales de embalaje de este producto son reciclables y se pueden volver a utilizar. Disponga de estos materiales siguiendo los reglamentos de reciclaje de su localidad.

Cuando se deshaga de la unidad, cumpla con las reglas o reglamentos locales.

Las pilas nunca deberán tirarse ni incinerarse. Deberá disponer de ellas siguiendo los reglamentos de su localidad relacionados con los desperdicios químicos.

Este producto junto con los accesorios empaquetados es el producto aplicable a la directiva RAEE excepto pilas.

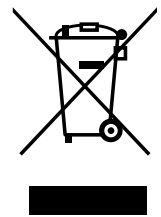
**EEN AANTEKENING WAT BETREFT HET RECYCLEREN:**

Het inpakmateriaal van dit product is recycleerbaar en kan opnieuw gebruikt worden. Er wordt verzocht om zich van elk afvalmateriaal te ontdoen volgens de plaatselijke voorschriften.

Volg voor het wegdoen van de speler de voorschriften voor de verwijdering van wit- en bruingoed op.

Batterijen mogen nooit worden weggegooid of verbrand, maar moeten volgens de plaatselijke voorschriften betreffende chemisch afval worden verwijderd.

Op dit product en de meegeleverde accessoires, m.u.v. de batterijen is de richtlijn voor afgedankte elektrische en elektronische apparaten (WEEE) van toepassing.

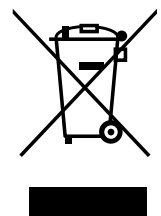
**EN KOMMENTAR OM ÅTERVINNING:**

Produktens emballage är återvinningsbart och kan återanvändas. Kassera det enligt lokala återvinningsbestämmelser.







När du kasserar enheten ska du göra det i överensstämmelse med lokala regler och bestämmelser.

Batterier får absolut inte kastas i soporna eller brännas. Kassera dem enligt lokala bestämmelser för kemiskt avfall.

Denna apparat och de tillbehör som levereras med den är de som uppfyller gällande WEEE-direktiv, med undantag av batterierna.





- Use compact discs that include the  mark.
CD's with special shapes (heart-shaped CD's, octagonal CD's etc.) cannot be played on this set.
Attempting to do so may damage the set. Do not use such CD's.
- Benutzen Sie Compact Discs, die das  Zeichen tragen.
Speziell geformte CD's (herzförmige CDs, achteckige CDs, usw.) können auf dieser Anlage nicht abgespielt werden.
Der Versuch derartige CDs abzuspielen kann die Anlage beschädigen. Verzichten Sie auf die Benutzung solcher CDs.
- Utiliser des disques compacts portant le logo  .
Des CD avec des formes spéciales (CD en forme de coeur, des CD octogonaux, etc.) ne peuvent pas être lus sur cet appareil.
Le fait de l'essayer, risque d'endommager le lecteur. Ne pas utiliser de tels CD.
- Utilizzare compact disc contrassegnati con  .
Non è possibile eseguire in questa unità CD con forme speciali (CD a forma di cuore, ottagonali, ecc.), poiché possono danneggiare il prodotto. Non utilizzare tali CD.
- Use discos compactos con la marca  .
En este equipo no es posible reproducir CDs con formas especiales (CDs con forma de corazón, CDs octogonales, etc.).
Si intenta hacerlo, el equipo podrá resultar dañado. No use este tipo de CDs.
- Gebruik compact discs voorzien van het logo  .
CD's met speciale vormen (bijv. CD's in de vorm van een hart, achthoekige CD's, enz.) kunnen met dit toestel niet worden afgespeeld.
Wanneer u dit toch probeert, zal u het toestel beschadigen. Speel dergelijke CD's dus niet af.
- Använd CD-skivor med  -märket.
Specialformade CD-skivor (hjärtformade, åttkantiga, m m) går inte att spela på den här apparaten.
Utrustningen kan skadas om du försöker göra detta.
Använd inte CD-skivor av denna typ.

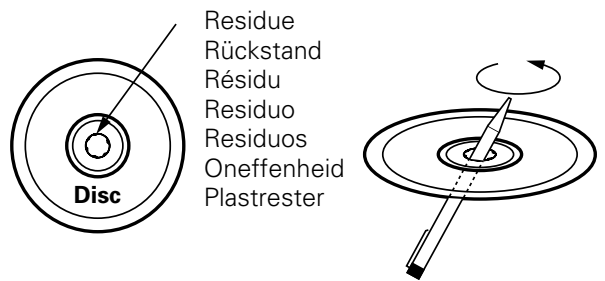

- The disc may not play normally if there is residue along the edges of the center hole.
- When using new discs in particular, use a pen, etc., to remove the residue.
- Die Disk kann nicht normal abgespielt werden, wenn sich ein Rückstand entlang der Mittellochenden befindet.
- Insbesondere, wenn Sie neue Disks benutzen, dann entfernen Sie mit einem Stift, etc. den Rückstand.
- Le disque peut ne pas être lu normalements s'il y a un résidu le long des bord du trou central.
- Lors de l'utilisation de nouveaux disques en particulier, utiliser un stylo à bille, etc., pour enlever le résidu.
- Il disco non viene eseguito in modo corretto se sono presenti residuo ai bordi del foro centrale.
- Quando si utilizzano dischi nuovi, utilizzare una penna o uno strumento simile, per rimuovere i residui.
- El disco no puede ser reproducido normalmente debido a la terminación deficiente de los bordes del agujero central.
- Para quitar estos residuos de material, especialmente cuando vaya a re-reproducir discos nuevos, utilice un bolígrafo, o algo similar.
- Het is mogelijk dat de disc niet normaal wordt weergegeven als de randen van het middengat van de schijf oneffenheden vertonen.
- Verwijder vooral bij gebruik van nieuwe discs de oneffenheden met een pen of iets dergelijks.
- Det kan uppstå fel vid CD-avspelningen om det finns plastrester kvar i mitthålet.
- Tänk på att bort dessa med en penna, e d, särskilt om CD-skivan är ny.



- This unit can display text information on the display when playing CD text discs which contain text information in English category.

The CD text disc includes the mark shown at the right.

NOTE:

- This unit can provide a text display of the following types of characters. Other types of characters will result in " " being displayed.

- Alphabet
 ABCDEFGHIJKLMNOPQRSTUVWXYZ
 abcdefghijklmnopqrstuvwxyz
- Numbers
 0123456789
- Symbols
 _!"#\$%&'()*+,-./:;=<>
 ?@[]\`^_~ SPACE^■

- Bei der Wiedergabe von CD-Textdiscs, die Funktionstasten in englischer Kategorie enthalten, kann dieses Gerät auf dem Display Funktionstasten anzeigen. Die CD-Textdiscs sind mit dem rechts dargestellten Logo versehen.

HINWEIS:

- Dieses Gerät kann aus den nachfolgend aufgeführten Zeichenarten bestehende Texte anzeigen. Bei anderen Zeichenarten wird " " angezeigt.

- Alphabet
 ABCDEFGHIJKLMNOPQRSTUVWXYZ
 abcdefghijklmnopqrstuvwxyz
- Zahlen
 0123456789
- Symbole
 _!"#\$%&'()*+,-./:;=<>
 ?@[]\`^_~ SPACE^■

- Cet appareil peut afficher les textes d'information lors de la lecture de CD qui comportent ces textes, dans la catégorie anglaise.

Les CD avec texte se repèrent à la marque indiquée à droite.

REMARQUE:

- Cet appareil permet l'affichage de textes composés avec les types de caractère suivants. Tous les autres types de caractère seront affichés ainsi " ".

- Alphabétiques
 ABCDEFGHIJKLMNOPQRSTUVWXYZ
 abcdefghijklmnopqrstuvwxyz
- Chiffres
 0123456789
- Symboles
 _!"#\$%&'()*+,-./:;=<>
 ?@[]\`^_~ SPACE^■

- Quest'unità può visualizzare dei testi sul display durante la riproduzione di CD che contengono dei testi in inglese. Il disco CD con testi include il marchio mostrato qui a destra.

NOTA:

- Quest'unità è in grado di fornire una visualizzazione dei testi usando i seguenti tipi di caratteri. Altri tipi di caratteri causeranno la visualizzazione dell'indicazione " ".

- Alfabeto
 ABCDEFGHIJKLMNOPQRSTUVWXYZ
 abcdefghijklmnopqrstuvwxyz
- Numeri
 0123456789
- Simboli
 _!"#\$%&'()*+,-./:;=<>
 ?@[]\`^_~ SPACE^■

- Esta unidad puede mostrar información de texto en la pantalla cuando se reproducen discos CD de Texto que contengan información de texto en la categoría de Inglés. Los discos CD de Texto incluyen la marca indicada a la derecha.

NOTA:

- Esta unidad puede mostrar visualizaciones de texto de los siguientes tipos de caracteres. Otros tipos de caracteres harán que se visualice " ".

- Alfabeto
 ABCDEFGHIJKLMNOPQRSTUVWXYZ
 abcdefghijklmnopqrstuvwxyz
- Números
 0123456789
- Símbolos
 _!"#\$%&'()*+,-./:;=<>
 ?@[]\`^_~ SPACE^■

- Dit toestel kan tekstinformatie op het display tonen bij het weergeven van CD-Text discs met tekstinformatie in de categorie Engels.

Een CD-Text disc is voorzien van het logo rechts.

OPMERKING:

- Dit toestel kan de volgende tekens als tekst weergeven. Voor andere types van tekens verschijnt " " op het display.

- Alfabet
 ABCDEFGHIJKLMNOPQRSTUVWXYZ
 abcdefghijklmnopqrstuvwxyz
- Getallen
 0123456789
- Symbolen
 _!"#\$%&'()*+,-./:;=<>
 ?@[]\`^_~ SPACE^■

- Denna apparat kan visa text på displayen när du spelar CD-textskivor innehållande information på engelska. CD text-skivor bär märket som anges på höger sida.

OBSERVERA:

- Apparaten kan visa text med följande teckentyper. För övriga tecken kommer " " att visas.

- Alfabetiska
 ABCDEFGHIJKLMNOPQRSTUVWXYZ
 abcdefghijklmnopqrstuvwxyz
- Siffror
 0123456789
- Symboler
 _!"#\$%&'()*+,-./:;=<>
 ?@[]\`^_~ SPACE^■

– TABLE OF CONTENTS –

1 Main features7	7 Seamless loop/Hot start and Stutter12
2 Connections/Installation7	8 MP3 Playback.....13, 14
3 Part names and functions8 ~ 10	9 Other functions.....14
4 Compact discs10	10 Memo14, 15
5 Basic operation10, 11	11 Preset15
6 Pitch/Brake11	12 Specifications16

■ ACCESSORIES

Check that the following parts are included in addition to the main unit:

① Operating instructions1	④ Remote control connection cable.....1
② Connection cords for signal output (RCA)2	⑤ Service Station List.....1
③ Remote control unit (RC-D45)1	

1 MAIN FEATURES

The DN-D4500 is a double CD/MP3 player equipped with a variety of functions and high performance characteristics, specifically designed for Mobile and Club DJ's around the world.

Control section

- 1. The DN-D4500 can be easily mounted on a standard 19-inch rack.**
- 2. Improved visibility under low lighting conditions thanks to a large fluorescent display, back-lit illuminated action buttons and illuminated disc trays.**
- 3. Improved interface operation thanks to a large jog/Shuttle wheel and track select knob.**

Functions

- 1. Shockproof function protecting against external vibrations**
- 2. Auto Level Search / Instant Start**
- 3. Pitch / Pitch Bend & Key Adjust**
- 4. MP3 Playback**

It is possible to play MP3 files created in the specified format found on page 13.

Files can be searched for easily either manually, or by scanning or using a number of file search functions (File search, File/Folder search, Artist name search, Title name search, File name search).

- 5. Seamless Loop**

Playback can be looped between any two points in a track without any break in the audio. Two loop start points (A-1 and A-2) can be set anywhere within the track or disc.

- 6. Hot Start / Stutter**

Playback can be started instantaneously from points A-1 and A-2.

In the stutter mode, these same buttons play momentary audio while pressed and held down.

- 7. Brake**

- 8. Relay Play**

When this mode is set, CD1 and CD2 starts playback alternately.

This unit can relay the playback of CD1 and CD2 every track or every disc.

- 9. Power on Play**

The player can be set so that playback in the relay mode starts when the power is turned on.

- 10. Fader Start**

The DN-D4500 FADER START controls are compatible with our DN-X400, DN-X500, DN-X800, DN-X900 or DN-X1500 mixers.

- 11. Auto Disc Tray Close System**

- 12. Preset functions - Different presets can be changed according to your needs.**

- 13. Custom Setting Memory**

- 14. CD TEXT / MP3 ID3 Tag name display**

- 15. CD-R / RW Playback**

This player can play CD-R/RW discs, but only if they are finalized.

Note: However that depending on the recording quality, the player may not be able to play some finalized CD-R/RW discs.

PANEL FRONTAL

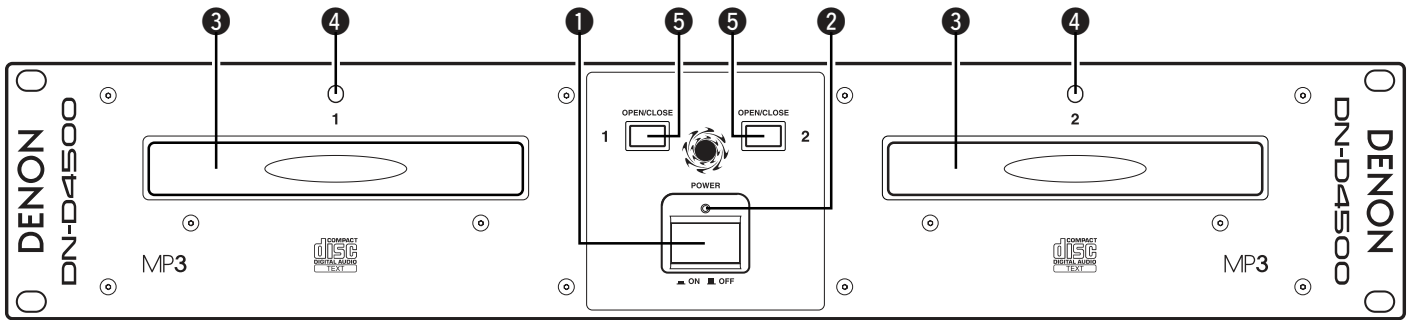
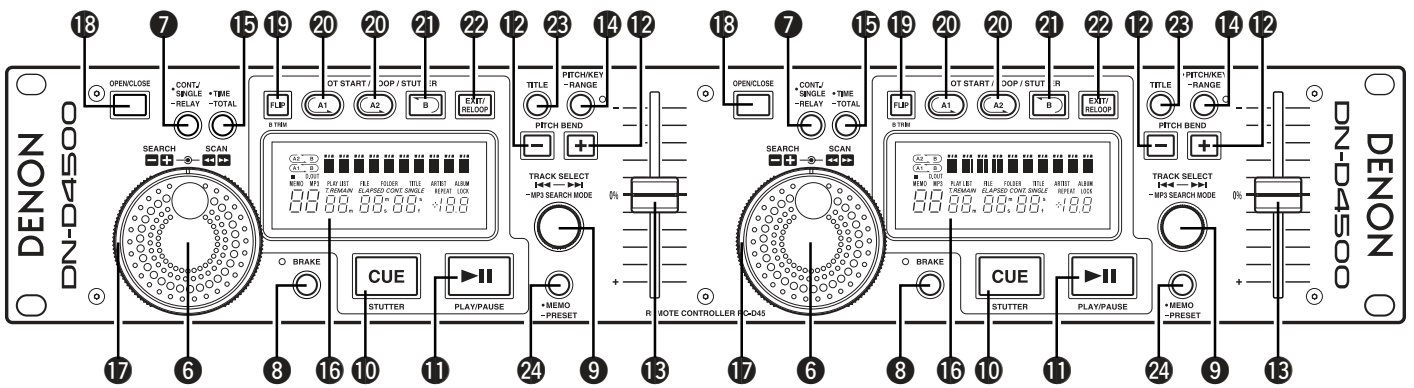

3	4
1	

1	5	5	2
1	OPEN/CLOSE	OPEN/CLOSE	2
	POWER		
	ON	OFF	

3	4
2	

2 CONNECTIONS/INSTALLATION

1. Turn off the POWER switch.
2. Connect the RCA pin cords to the inputs on your mixer.
3. Connect the control cord to the REMOTE connector on the RC-D45.

CAUTION:

- Be sure to use the supplied control cord. Using another type of cable may result in damage.
- Be sure the power is off when connecting the control cord. Otherwise the units may not work properly.
- Never connect any remote controllers other than the RC-D45. Doing so can damage the equipment.

The DN-D4500 will work normally when the player unit is mounted within 10 degrees off the vertical plane at the front panel. If the unit is tilted excessively, the disc may not be loaded or unloaded properly.

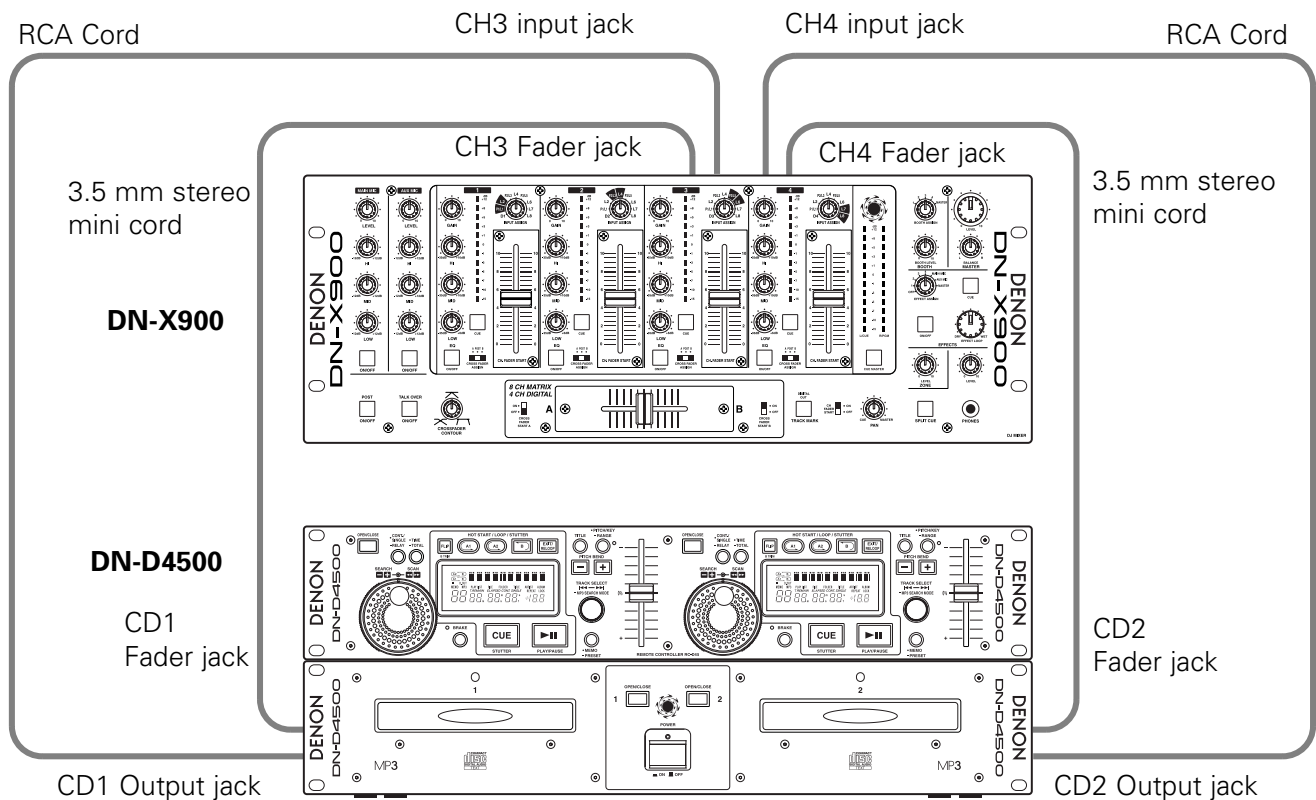
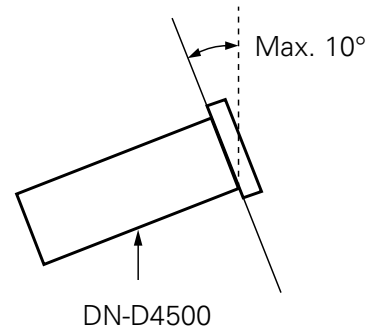

NOTE:

- Use a commercially available 3.5mm stereo mini cord for the Fader jack connections.

3 PART NAMES AND FUNCTIONS (Refer to page 3.)

(1) DN-D4500 Front panel

1 POWER button (ON OFF)

- Push this button to turn the power on.

NOTE:

- Be sure to close the disc holders before turning off the power.

2 POWER indicator

- This lights when the power is on.

3 Disc holder

- Place discs in this holder.
- Push the disc holder OPEN/CLOSE button to open and close the disc holder.

CAUTION:

- Do not place foreign objects in the disc holders. Doing so could damage the player.
- Do not push the disc tray in manually when the power is off, as this may result in malfunction and damage the player.

4 Disc holder LED

- This flashes while the disc holder is opening and closing.
- The LED lights when the disc holder is open and serves as the disc holder illumination.

5 Disc holder OPEN/CLOSE button

- Push this button to open and close the disc holder.
- The disc holder will not open during playback. Stop playback before pushing this button.

(2) RC-D45 Front panel

CAUTION:

- Note that there are many buttons working two different functions selected by short time pushing or long pushing (1second or more). The
 - mark indicates short time push function and
 - mark indicates long time push function.

6 Jog wheel (inner wheel)

- In the pause, CUE or Frame repeat mode, turn this wheel during for search operation to find the CUE point in units of frames.
- In the Playback mode, turn this wheel to temporarily pitch bend the playing speed.

7 Continue/Single button

(• CONT./SINGLE, — RELAY)

• CONT./SINGLE:

Short pushing play ending mode between CONT. (continue: play more tracks) and SINGLE (stop playing and ReCUE's back to your set point).

• SINGLE PLAY LOCK:

SINGLE PLAY LOCK can be selected by PRESET(10). At this time, if this button is pushed, it will be selected. When SINGLE PLAY LOCK is selected, track selection during playback is disabled. This prevents playback from stopping when the Track Select Knob is turned accidentally during playback. Play ending mode is the same as single.

• RELAY:

When this button is pushed for more than 1 sec, you can turn on and off RELAY PLAY mode.

8 BRAKE button

When this button is pushed you can turn the Brake mode on and off.

9 TRACK SELECT/MP3 SEARCH

MODE knob

- **TRACK:**

Turn this knob to select the first or next track to be played.

Turn the knob clockwise by one click to move one track forward, counterclockwise by one click to move one track backward.

When the knob is turned while pressing it down, one click corresponds to advancing 10 tracks at a time.

In the Preset and Memo mode, use this knob to set and enter Preset and Memo settings.

- **MP3 SEARCH MODE:MP3 DISC only.**

When pushing this knob down for more than 1 second, the MP3 file search selection mode is selected.

10 CUE button

- Pushing the CUE button during play provides a return to the position at which play was started. Alternately pushing the PLAY/PAUSE button and the CUE button allows the CD to be played from the same position any number of times.
- The CUE button lit, when the standby mode is set.
- In CUE mode, by pushing the CUE button makes a Stutter sound from the CUE point. This is called Stutter play for added performance. (Stutter)

11 PLAY/PAUSE button (▶||)

- Use this button to start playback.
- Push once to start playback, once again to set the pause mode, and once more to resume playback.
- When the Brake mode is ON, push the Play/Pause to activate the Brake sound.

12 PITCH BEND +/- button

- The playing speed increases/decreases while these buttons are held down.
- When either button is released, the playing speed returns to the previous speed.

13 Pitch slider

- Use this to adjust the playing speed.
- The playing speed decreases when moved upwards and increases when moved downwards.

14 ● PITCH/KEY, – RANGE button

- With this button you can select PITCH and KEY ADJUST mode. Mode changes Pitch on, Key Adjust on and both off cyclically. Green LED indicates in Pitch mode and Orange indicator in Key Adjust mode. No LED indicates OFF mode.
- **RANGE:**
Push this button for more than 1 sec to select the pitch range. The pitch range can be selected with the TRACK SELECT knob from ± 4 , 10, *16, 24, 50 or 100%. (*Max pitch for MP3)

15 ● TIME, – TOTAL button

- Push this to switch the time display between the elapsed time or remaining time per track or per disc.
- When this button is pushed for more 1 second, you can display the total time. (4 way, audio, CD only)

16 Display

- See page 9.

17 Shuttle ring (outer ring)

- This control is used to select the scanning direction and speed.
The CD is scanned in the forward direction when the shuttle ring is turned clockwise from the center position. To scan backwards, the shuttle ring is turned counterclockwise.
- The scanning speed increases as the wheel is turned further.

18 Disc holder OPEN/CLOSE button

- Push this button to open and close the disc holder.
- The disc holder will not open during playback. Stop playback before pushing this button.

19 FLIP/B TRIM button

- Push this button to switch between the loop mode/hot start mode and stutter mode.
- After setting the B point, the B TRIM MODE can be selected.

20 A1, A2 buttons

- Push these buttons to set the start point for loop playback (point A-1 or A-2).
- Push these buttons to use the stutter and hot start functions.

21 B button

- Push this button to set the end point for loop playback (point B).

22 EXIT/RELOOP button

- When this button is pushed during a seamless loop, the track resumes back to normal play from the B point. (EXIT)
When pushed again, the playback jumps back into your A-B seamless loop. (RELOOP)

23 TITLE button

• CD TEXT:

When there is CD text data, the CD text data is displayed automatically or when the button is pressed.

If no TEXT is available, the display will indicate "No TEXT".

• MP3:

When an MP3 file has ID-3 tag data, the title, artist name and album name can be selected and displayed each time the button is pressed.

24 • MEMO, – PRESET button

• MEMO:

The memo mode starts when this button is pushed once in the CUE mode.

• PRESET:

When this button is pushed for more than 1 sec, the PRESET mode starts.

NOTE:

- Memo's can not be set for MP3 files.

(3) DN-D4500 Rear panel

25 Analog output jacks 1, 2 (ANALOG OUT 1, 2)

- These are unbalanced output jacks. The audio signals from the both players are output from these jacks.

26 Digital output jacks 1, 2 (DIGITAL OUT 1, 2)

- Digital data is available from this jack.
- Use 75 Ω/ohms pin cord for connection.
- We recommend you use braided wire type shielded cable.

NOTE: The playback level after analog conversion is set to -6dB below the usual level to avoid digital distortion.

27 Fader input jacks 1, 2 (FADER 1, 2)

- Use this when your mixer has Fader Start function with 3.5 mm stereo mini cord.

28 Remote control connector (REMOTE)

- Connect the supplied 8pin din cable to the RC-D45 control unit.

(4) RC-D45 Rear panel

29 Control connector

- Connect the opposite side of supplied 8pin din cable to the DN-D4500 (main unit).

(5) Display

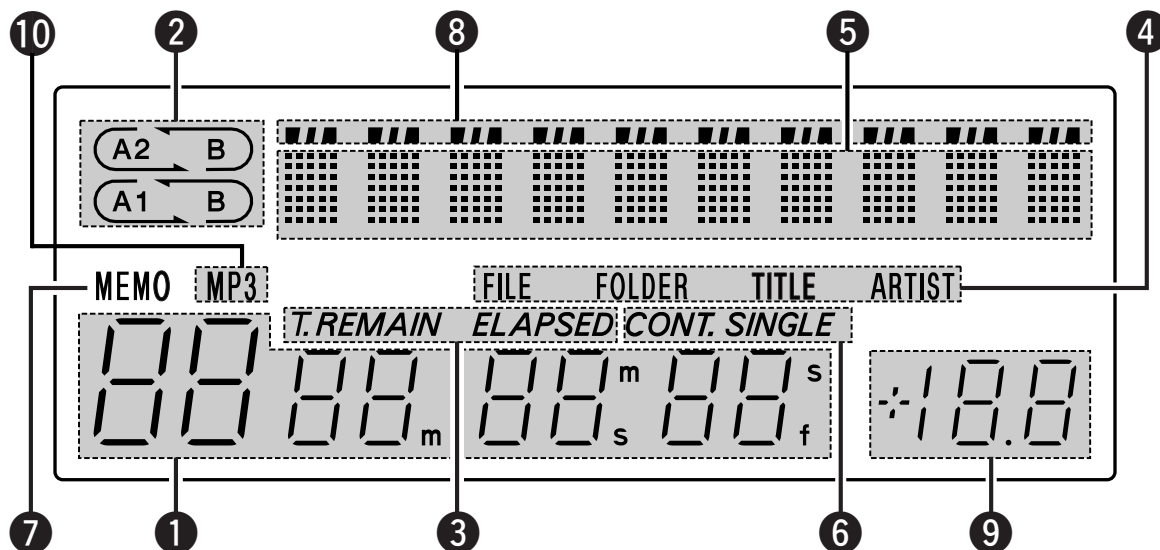

1 Track, minute, second and frame displays

- These displays indicate current position information.

2 Loop mode indicators

- DN-D4500 has Loop mode indicators consist of two sets of A (A1, A2), B and two arrows. A and B marks indicate A and B points are set.
- Two arrows indicate loop setting mode as follows.

Example: A1 B

(A1 → B) Both arrows on:

Seamless Loop mode

(A1 → B), (← →) Both arrows flashing:

Seamless Loop Playing

(A1 → B), (← →) Left arrow on, right flashing:

Exit play from Seamless Loop

3 Time mode indicators

- When the TIME/TOTAL button is pushed, the Time mode indicator switches as follows:

ELAPSED:

Track's elapsed time is displayed.

REMAIN:

Track's remaining time is displayed.

T. + ELAPSED:

The total elapsed time of disc or programmed track is displayed.

T. + REMAIN:

The total remaining time of disc or programmed track is displayed.

4 MP3 file search mode indicator

FILE:

FILE indicator appears in display, when in the FILE name search mode.

FOLDER:

FOLDER indicator appears in display, when in the FILE & FOLDER name search mode.

TITLE:

TITLE indicator appears in display, when in the TITLE name search mode.

ARTIST:

ARTIST indicator appears in display, when in the ARTIST name search mode.

5 Character display

- This displays various operational information, text message, etc.

6 Play mode indicators

- When SINGLE indicator lights up, playback will finish at end of current track.
- When CONT. indicator lights up, playback continues to the end of the disc.

7 MEMO indicator

- MEMO sign appears in display when there is a memory setting for the currently playing track or the track at which the standby mode is currently set.

8 Play Position indicators

- **Play position indicator:**

The 30 white dots indicate where is playing visually in a track in the normal play.

- **End of Message:**

When the time remaining to the end of the track is less than the specified time, the EOM(End Of Message) play position indicator flashes along with the remaining time, a notification to the user that the track will end soon.

* The EOM time can be set within the preset mode.

9 Pitch display

- This numeric indicator display the playback speed (pitch).

10 MP3 indicators

- Lights when an MP3 disc is detected.

4 COMPACT DISCS

(1) Precautions on handling compact discs

- Do not allow fingerprints, oil or dust on the surface of the compact disc. If the signal surface is dirty, wipe it off with a soft, dry cloth. Wipe in circular motions from the center and out.
- Do not use water, benzene, thinner, record sprays, electrostatic proof chemicals, or silicone-treated cloth to clean discs. Do not clean the disc using your shirt or pants, as this will cause damage to the disc.
- Always use care when handling discs to prevent damaging the surface, in particular when removing a disc from the case and returning it.
- Do not bend compact discs.
- Do not apply heat to compact discs.
- Do not enlarge the hole in the center of the disc.
- Do not write on the disc and do not attach any labels.
- Condensation will form on the disc surface if it is brought into a warm room from a cold area, such as outdoors during winter. Wait until the condensation disappears. Never dry discs with hair dryers, etc.

(2) Precautions on storage

- After playing a disc, always return it to its case.
- Keep discs in the cases when they are not to be played. This will protect them from dust and dirt and prolong their service life.
- Do not store discs in the following places:
 - 1) Places exposed to direct sunlight for a considerable time.
 - 2) Places subject to accumulation of dust or high humidity.
 - 3) Places exposed to high temperatures, such as close to heater outlets.

5 BASIC OPERATION

(1) PLAY/PAUSE and CUE

- The operation switches between playback and pause each time the PLAY/PAUSE button ⑪ is pushed.
- When the CUE button ⑩ is pushed during playback, the pickup returns to the position at which playback was started.

The diagrams below show playback patterns when the PLAY/PAUSE and CUE buttons are pushed.

PLAY and PAUSE

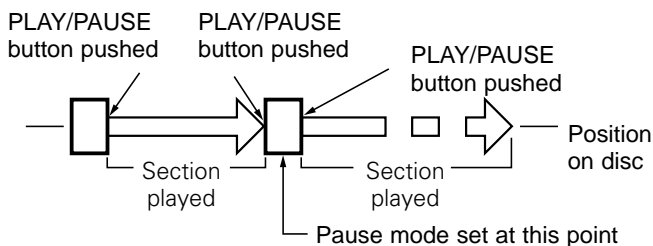

When the PLAY/PAUSE button ⑪ is pushed, playback starts and proceeds as shown by the arrow on the diagram above.

If the PLAY/PAUSE button ⑪ is pushed again during playback, the pause mode is set at that point. Push the PLAY/PAUSE button ⑪ again to resume playback.

PLAY and CUE

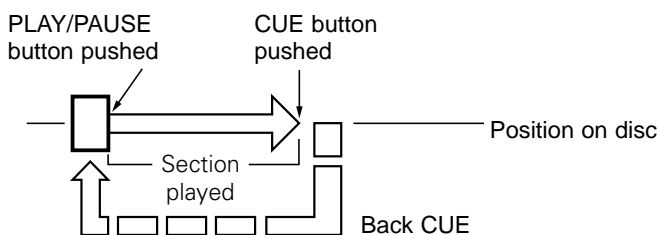

When the CUE button ⑩ is pushed after starting playback by pushing the PLAY/PAUSE button ⑪, the pickup returns to the position at which playback was started and prepares for the next playback.

Push the PLAY/PAUSE ⑪ and CUE ⑩ buttons alternately to start playback repeatedly from the same position. (Checking the playback position) This function is called "Back CUE".

PLAY, PAUSE and CUE

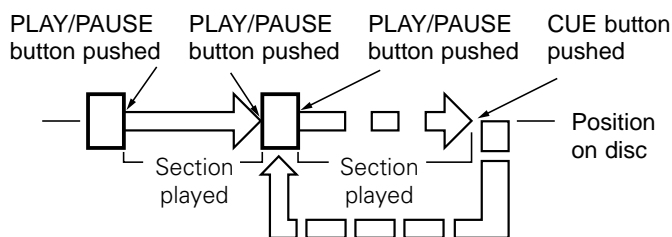

If the pause mode is set and playback is then resumed, the position to which the pickup returns with the Back CUE function changes.

(2) Starting playback from the Middle of a track (Manual Search)



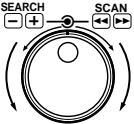
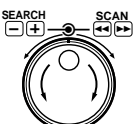

- When the track is selected with the TRACK SELECT knob ⑨ and the PLAY/PAUSE button ⑪ is pushed, playback starts from the beginning of that track. If you wish to start from a different position, use the procedure described below to search for the desired position.

1	<p>Find the play start position. Turn the shuttle ring ⑰ to change the playback position quickly. (Search for the approximate playback position.)</p>  <p>The fast forward/reverse mode is set when the shuttle ring (outer side) ⑰ is turned. The speed changes according to the angle at which the ring is turned.</p> <p>RVS FWD</p> <ul style="list-style-type: none">When operated during playback, playback resumes after the operation.When playback is started, the jog wheel is set to the bend mode.When turned fully in either direction, the playback position jumps about 10 seconds. The jump time can be selected in the preset mode from 10, 20, 30 or 60 sec.	<p>Shockproof memory</p> <ul style="list-style-type: none">A maximum of approximately 20 seconds uncompressed audio data is stored into memory (per drive). This guards audible interruptions due to external mechanical shocks such as bumps or other hard vibrations.If advanced data reading is not possible due to scratches or dirt on the disc, playback stops once the data stored up to that point is read.
2	<p>Turn the jog wheel ⑥. (Search for the precise playback position.)</p>  <p>When the jog wheel (inner side) ⑥ is turned, the frame move mode is set. The playback position can be moved in units of one frame.</p> <p>RVS FWD</p> <p>Listen to the sound and find the desired play start position.</p> <p>NOTE:</p> <ul style="list-style-type: none">For MP3 discs, frames are not displayed, however frame resolution is audible by turning the jog wheel (inner side) ⑥.	

6 PITCH/BRAKE

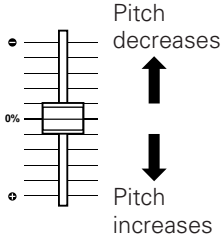

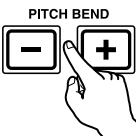
- There are two ways to change the playing speed.
 - Adjust the Pitch using the pitch slider 13.
 - The PITCH BEND button 12 or jog wheel 6 can be used to temporarily change the pitch.
- The playing speed can be changed greatly to achieve effect similar to those achievable with analog vinyl.
- If you wish to preserve the original key of sound, set the Key Adjust function to ON.

(1) Pitch

1-1	<p>[Pitch slider] Set the variable speed mode. Push the PITCH button 14 to light the PITCH LED.</p> <ul style="list-style-type: none"> • PITCH → KEY (key adjust) → OFF (Green) (Orange) (Off) (LED color) 
1-2	 <p>The Pitch decreases when the pitch slider 13 is moved upwards, increases when the pitch slider 13 is moved downwards.</p>
1-3	<p>DN-D4500 has six pitch ranges, 4%, 10%, *16%, 24%, 50% and 100%. (*Max MP3) When the RANGE button 14 is pushed for more than 1 sec, the pitch range can be selected by turning the TRACK SELECT knob 9.</p> <ul style="list-style-type: none"> • When the TRACK SELECT knob 9 is pushed down the pitch range is entered and the pitch range selection mode is completed.  
2-1	<p>[PITCH BEND button] Push the PITCH BEND + (or PITCH BEND -) button 12.</p>  <ul style="list-style-type: none"> • The Pitch increases or decreases temporarily while the PITCH BEND + or PITCH BEND - button 12 is pushed. • The extent to which the PITCH BEND button 12 changes the Pitch is proportionate to the amount of time the button is pushed. The longer the button is held down, the greater the percentage of change.
2-2	<p>Set the jog wheel to the pitch bend mode. During playback, pitch bend is setting for the Jog wheel.</p>  <ul style="list-style-type: none"> • The playing speed increases gradually when the jog wheel 6 is turned clockwise and decreases gradually when the jog wheel 6 is turned counterclockwise. When you stop turning the jog wheel 6, the playing speed returns to the previous speed. • When playback is stopped, the jog/shuttle wheel is set to the search mode.



(2) BRAKE



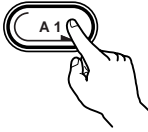

- Use this function to achieve effect similar to analog players.

1	<p>Push the BRAKE button 8 to light the BRAKE LED.</p> <ul style="list-style-type: none"> • The effect sound is similar to a DJ turntable coming to a quick stop. This effect can be achieved by pushing the PLAY/PAUSE button 11 during playback.  
---	---

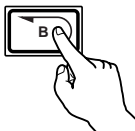
7 SEAMLESS LOOP/HOT START AND STUTTER



(1) Seamless Loop/Hot Start/Stutter (A1, A2 buttons)

1	Setting the A point (loading the Hot Start data) Push the A1 or A2 button 20 to set the A point and Hot Start data.  <ul style="list-style-type: none">• A1 and A2 buttons can be used separately for each Hot Start.• When an A point is set, the corresponding A button light and that button is set to the Hot Start mode.
2	Starts Hot Start When A1 or A2 button 20 is pushed, Hot Start playback starts from the corresponding A point. 
3	Setting the B point for Seamless Loop When the B button 21 is pushed after setting the A point or after starting Hot start playback, the B point is set and Seamless Loop playback starts from the A point.  <ul style="list-style-type: none">• The B button works with respect to the A point operated before the B button 21 was pushed.• If the B button 21 is pushed during seamless loop playback or after EXIT playback, the B point (or Loop) moves to the point at which the button was pushed.
4	Management of 2 seamless loops <ul style="list-style-type: none">• When the B point for A1 is detected after playback started from A1 point, playback returns to A1 point seamlessly. While A1 to B looping, B point for A2 ignored.• When the B point for A2 is detected after playback started from A2 point, playback returns to A2 point seamlessly. While A2 to B looping, B point for A1 ignored.

5	Exit/Reloop During Seamless Loop playback, you can exit or return to your loop.  EXIT: While the Seamless Loop playback, push the EXIT/RELOOP button 22 to exit from looping. DN-D4500 continues playback after the B point. RELOOP: When the EXIT/RELOOP button 22 is pushed after exiting the loop, Seamless Loop playback resumes from the A point instantly.
6	Stutter <ul style="list-style-type: none">• A1 and A2 points can be also used for Stutter playback. To enable stutter playback, push FLIP/B TRIM button 19 for A1/A2 buttons. The display will indicate STR. Push the FLIP/B TRIM button 19 to switch between the Hot Start/Seamless Loop and Stutter modes. 
7	Clear the A1/A2 point While pressing the FLIP/B TRIM button 19, push the A1 or A2 button to clear the corresponding A and B points. Or push the FLIP/B TRIM button 19 for more than 1 sec to clear both A1 and A2 points at once. Quickly pressing the FLIP/B TRIM button 19 first and then A1, A2 or B buttons will clear these points individually.  

(2) B Trim

- The Seamless Loop B points can be fine-adjusted in real-time using the Jog wheel.
- Trim the points live during loop playback for rehearsal monitoring.

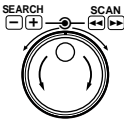
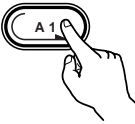
1	<p>① When the FLIP/B TRIM button 19 is pushed during seamless loop playback, the "Trim Mode" function is turned on. → 3</p> <p>When the FLIP/B TRIM button 19 is pushed 1 or 2 times during playback or pause, the B TRIM mode is selected.</p> 
2	<p>Select B point</p> <p>② If more than 2 loops are set, the corresponding A1/A2 button 20 to your B point loop needs to be selected, otherwise B trim defaults to the last loop that was made.</p> 
3	<p>Trim B point</p> <p>③ Turn the Jog wheel 6 (inner side) slowly to move the B point 1 frame at a time.</p>  <ul style="list-style-type: none">• Range for trimming B point is limited as follows. Between 5 frames after A point and disc end. <p>*MP3 Between 5 frames after A point and file end.</p>
4	<p>Save the B point</p> <p>④ Push the flashing A1/A2 button 20 again to save new B point, and the unit will automatically exit from the B Trim mode.</p> 

8 MP3 PLAYBACK

The DN-D4500 can playback MP3 files via CD-R/RW media made according to the following conditions.

* MP3 disc's made by formats other than below settings cannot be played back on our system.

* In most cases, you can find the below settings within the properties of your burners PC software.

Please refer to your manual or contact your software vendor for assistance regarding these settings.

- NOTE:**
- Depending on the type of MP3 encoding or writing software, with some files noise may be generated or it may not be possible to play the file.
 - Recordings you make are for your personal use and should not be used in ways infringing upon the copyright holder as per copyright laws.

MP3 FORMAT

Disc Format	Applicable file extensions	.mp3 .MP3 .mP3 .Mp3
	ISO9660	Level 1(max. 8/"8.3" character style)
		Level 2 (max. 31/30 character style)
	Joliet	max. 63/63 character style
	Romeo	max. 63/63 character style
	CD-ROM sector format	mode-1 only
	Folder/directory hierarchical level	max. 8 levels down (* note #1)
	Max. number of Folders	No limit (* note #2)
Max. number of files	max. 999 files (* note #3)	
MP3 Format	MPEG-1	Audio Layer-3 32-320kbps, f/s 44.1kHz
	ID-3 Tag	V1.0, V1.1, V2.2, V2.3, V2.4
	Encoding	C.B.R , V.B.R
	NOTE : .m3u Play List are not supported.	
Disc Writing Method	Disc at Once and Track at Once	
	Multi Session	If the 1st session is CDDA, you can playback only CDDA track. If the 1st session is MP3, you can playback only MP3 file.
	NOTE : Packet Write is not supported.	

note #1 Cannot playback files in a folder located further from the specified Folder/directory hierarchical level.

note #2 The number of total folders is not limited, while the number of total files is limited.

note #3 If the number of files exceeds 999, the unit can play first 999 files, and no further files are recognized.

Display

- The elapsed file playing time and the remaining file playing time (for C.B.R files only) can be selected.
- The file name display, folder name display and ID-3 tag can (title/artist name/album name) be displayed. Each time the TITLE button is pushed, the file name display/folder name display, title display, artist name display or album name display are selected.

NOTE:

Title, Artist and Album name utilizes the data from the ID-3 tag.(if available)

Data from the file name "root" is not used as the ID-3 tag.

Play, Pause and CUE

- Like with a normal CD, it is possible to play, pause and back-CUE.
- Pitch range, 4%, 10%, 16%

NOTE:

- When you back CUE V.B.R. encoded files, the start position returns to the head of file 00:00:00 rather than where music is detected.

Select the file

1	<p>Select the file search modes</p> <p>For MP3 discs, the file search modes described below can be selected by pushing the TRACK SELECT/MP3 SEARCH MODE knob ⑨ and holding it in for over 1 second.</p> <ul style="list-style-type: none"> The file search mode is selected by turning the TRACK SELECT/MP3 SEARCH MODE knob ⑨ and set by pushing the knob.
2	<p>File search (File)</p> <ul style="list-style-type: none"> When the TRACK SELECT/MP3 SEARCH MODE knob ⑨ is turned, file searching is performed in the order of the file numbers. When the TRACK SELECT/MP3 SEARCH MODE knob ⑨ is pushed in and turned, file searching is performed 10 files at a time.
3	<p>File/Folder search (FileFolder)</p> <ul style="list-style-type: none"> When the TRACK SELECT/MP3 SEARCH MODE knob ⑨ is turned, file searching is performed in the order of the file numbers. When the TRACK SELECT/MP3 SEARCH MODE knob ⑨ is pushed in and turned, folder searching is performed in the order of the folder numbers.
4	<p>Artist name search (ArtistName) Title name search (Title_Name)</p> <p>If the artist name or title name is recorded in the file name as described below, it is possible to search in alphabetical order of artist or title names.</p> <ul style="list-style-type: none"> When recorded in order of artist name and title name (Artist - title, (Artist)(Title), [Artist][Title]) and with "-", "()" or "[]" between artist names and title names, it is possible to search artist names and title names in alphabetical order. <p>NOTE:</p> <ul style="list-style-type: none"> These name search functions cannot be selected unless the file names are recorded in the specified format above. Title and artist name use the data of a file name. It is not data of ID-3 tag. <ul style="list-style-type: none"> When the artist name search or title name search mode is selected and the TRACK SELECT/MP3 SEARCH MODE knob ⑨ is pressed in while turned, name search is performed in the alphabetical order of the names. If the TRACK SELECT/MP3 SEARCH MODE knob ⑨ is turned after searching in alphabetical order is finished, file searching is performed in the order of the file numbers from the name with the selected letter. If the CUE button ⑩ is pushed after file searching, the searched file is searched for and the standby mode is set.

File name search (File_Name)

Files can be searched for by file name in alphabetical order.

5

- When the file name search function is selected and the TRACK SELECT/MP3 SEARCH MODE knob ⑨ is pushed in while turned, the file names are search in alphabetical order.
- If the TRACK SELECT/MP3 SEARCH MODE knob ⑨ is turned after searching in alphabetical order is finished, file searching is performed in the order of the file numbers from the file name with the selected letter.
- If the CUE button ⑩ is pushed after selecting the file, the selected file is searched for and the standby mode is set.

NOTE:

When the file name dose not correspond to the format of 4, file name search is selected.

Manual search

For only C.B.R files, manual searching can be performed.

NOTE:

- With manual searching, it is only possible to search within the selected file.
- Manual searching in the reverse direction is possible up to the point 5 seconds before the point at which searching starts.
- The searching speed may vary according to the file's compression rate, etc.
- V.B.R. is not supported with this function.

Seamless Loop/Hot start/Stutter/BTrim

For only C.B.R. files, Hot starting, seamless loop playback, stuttering and B trim can be performed in the same way as with normal CDs.

NOTE:

- The A and B points for the seamless loop must both be set within the same file.
- V.B.R. is not supported with these functions.

BRAKE

BRAKE is supported in the same way as with normal CDs.

9 OTHER FUNCTIONS

1. Relay play

- The unit can play CD1 and CD2 alternately.
- The relay mode is set when the CONT./SINGLE button **7** is pressed for over 1 second.

(1) Single relay mode

1	Press the CONT./SINGLE button 7 several times until "SINGLE" indicator flashes on the display.	
	<ul style="list-style-type: none">• When playback is finish of the desired track, the opposite drive will start to play.• When both CD1 and CD2 set to the SINGLE RELAY mode, endless play is available for the each track of CD1 and CD2 alternately.	

(2) Continuous relay mode

1	Press the CONT./SINGLE button 7 several times until "CONTINUOUS" indicator flashes on the display.	
	<ul style="list-style-type: none">• When playback is finish for the final track on the target disc, the opposite drive will start to play.• When both CD1 and CD2 set to the CONTINUOUS RELAY mode, endless play is available for each disc of CD1 and CD2 alternately.	

2. Disc tray auto close

1	Disc tray will automatically close after 30 seconds have elapsed for the disc tray auto close mode. (Preset item 3)
---	---

3. End of message

1	During playback, the Play Position indicators start flashing when the remaining playing time to the end of the track (set in the preset mode) is reached, indicating that the end of the track is near. (Preset item 6)
---	---

4. Power on play

1	When "Power On Play" is set to "ON" mode at "[11] PRESET (8)", playback starts from the first track on the disc when the power is turned on.
---	--

10 MEMO (Custom Setting Memory)

CD setting information can be stored in the non-volatile memory. The stored information can be called out of the memory later, making it easy to prepare for your mixing.

NOTE: The MEMO function cannot be used for MP3.

1. About TRACK MEMO

- Up to 1000 memo points can be stored to internal memory for later recall.
The number of tracks on a particular CD only limits the amount of memo points available per that disc.
Example: If your CD has 22 tracks, you can only save up to 22 memos. (1 memo group per track.)

CAUTION:

1000 is the maximum possible number of tracks that can be stored to memory.

However, to simplify the MEMO operations, the memory system manages each 200 MEMO data groups as a minimum unit (the total 1000 memory capacity divided into 5 memory data groups). When you want to clear just one MEMO data in the 1 MEMO CLEAR mode (see page 15), the unit will erase the memo information but not the internal memo allocation number. Accordingly, depending on conditions, the number of tracks that can be stored in the memory may be fewer than 1000.

Once you reached 1000 stored points, you will see a message that says "MEMO FULL!". At this time you will need to "delete" old data to make room for new memo points. Therefore the oldest 200 memo points in that group will be deleted and become available.

- The MEMO indicator on the display lights up when a track for which data is stored in the memory is selected.

2. MEMO ITEMS

The following items are max to be stored under 1 memory bank:

- ① CUE point.
- ② A1 and B1 points, A2 and B2 points.
- ③ Playing pitch, pitch range pitch on/off, Key Adjust on/off, Hot Start/Stutter setting.

3. MEMO MODE SELECT

- ① Push the MEMO button **24** in CUE mode to enter MEMO mode.
- ② Turn the TRACK SELECT knob **9** to select the various MEMO modes from as follows.

Memo Set, MemoCall, Memo Clr

Depending on conditions, some modes cannot be selected.

- ③ Push the MEMO button **24** again to exit MEMO mode.

(1) Storing data in the memory [Memo Set]

- After making your desired settings to be stored in memory, then push CUE button **10**.
- In CUE mode, push MEMO button **24** once to enable Memo set function.
- If the MEMO indicator is already lit up, it is necessary to clear existing Memo before storing a new Memo.
- At last push TRACK SELECT knob **9** down to save. You can see "Complete!" message and MEMO indicator lights up.

MEMO FULL

- If the memory is full and no more data can be stored, "Memo Full!" and "Del. 200?" message appears.
- In this case, you need to clear memory of First 200s Memo (number 1 to 200) at a time to make space for new memos.
- To make space, push TRACK SELECT knob **9** down while "Del. 200?" message is displayed.
- "Delete OK?" message appears then push TRACK SELECT knob **9** down again to execute clearing.
- After the first 200s Memo (number 0 to 199) are cleared, number after 200 Memo are renumbered as new 1, 2, 3...(now you have a new set of 200 empty spaces.).

(2) MEMO CALL [Memo Call]

- When a CD is first loaded that has Memo's previously saved, the MEMO indicator flashes for 5 seconds.
- To call out the Memo data, select the track that you made MEMO to. *The MEMO indicator lights up.
- Push the MEMO button **24** to enable Memo call function.
- When the TRACK SELECT knob **9** is pushed down in the Memo call mode, all the data stored in the memory is loaded. The DN-D4500 goes to standby mode at the called CUE point.
- When the playing pitch is loaded from the Memo with PITCH LED flashes, playing Pitch is locked until the Pitch Slider reaches the same saved Pitch value. While playing Pitch is locked & PITCH LED keeps flashing.
- If you do not wish to save the pitch&key information to memory, please turn the pitch made OFF before saving your new MEMO.

(3) 1 MEMO CLEAR [Memo Clr]

- To clear one Memo data, select the track that you made MEMO to. Then the MEMO indicator lights up.
- Push the MEMO button **24** to enable Memo clear mode. Then turn the TRACK SELECT knob **9** once clockwise to "Memo Clr?"
- When the TRACK SELECT knob **9** is pushed down in MEMO CLEAR mode, the Memo data is cleared and the MEMO indicator on the display turns off.

ALL MEMO CLEAR

- All memory data can be cleared.
- For instructions, see **11** PRESET "(15) MEMO ALL CLEAR".
- Be careful as this will delete ALL saved memory.

11 PRESET

1. Preset mode

- ① The preset mode is available when MEMO/PRESET button **24** is pushed for more than 1 sec while DN-D4500 is in CUE, pause or no disc mode.
- ② Turn the TRACK SELECT knob **9** to select the preset item.
- ③ After selecting an item, push the TRACK SELECT knob **9** down to select the preset data.
- ④ To change other Preset items, repeat these steps.
- ⑤ Push the MEMO/PRESET button **24**, CUE button **10** or PLAY/PAUSE button **11** to exit from the Preset mode.

2. Preset items and data

The "*" mark next to the data indicates the default value.

- (1) Auto CUE : Auto CUE level search on/off. (A.CUE ON* / A.CUE OFF)
- (2) BrakeTime : STEP 1 / STEP 2* / STEP 3 / STEP 4
Set the operating time for the BRAKE mode.
- (3) Auto Close : Close OFF / Close 10s / Close 30s* / Close1min
Time for automatically closing disc holder.
- (4) Jump Time : Jump10sec* / Jump20sec / Jump30sec / Jump1min
Select the jump time of QuickJump.
- (5) P. Range (PITCH RANGE) : 4% Range / 10% Range* / 16% Range / 24% Range
Select the playing pitch range when the power is turned on.
- (6) EOM Time :
EOM OFF / EOM 10 sec* / EOM 15 sec / EOM 20 sec / EOM 30sec / EOM 60 sec / EOM 90 sec
Track end message start time.

- (7) Fader Mode (FADER START MODE) : Play / CUE* / Play Pause
Select 2-line (TRS) type cable (CUE and Play) or 1 line (TS) type cable (Play and Pause).
- (8) Power Play (POWER ON PLAY) : P. Play ON / P. Play OFF*
Playback starts when the power is turned on if a disc is loaded.
- (9) Pitch : Pitch ON* / Key. AdjON (KEY ADJUST ON) / Pitch OFF
Select the pitch mode when the power is turned on.
- (10) Play Mode (SINGLE / CONTINUOUS / SINGLE PLAY LOCK) : Single / Cont. / Play Lock*
Select the play mode when the power is turned on.
- When SINGLE PLAY LOCK is selected, track selection during playback is disabled. This prevents playback from stopping when the TRACK SELECT knob ⑨ is turned accidentally during playback. This mode is valid even when selected after turning the power on.
- (11) Time Mode (ELAPSED / REMAIN) : Elapsed* / Remain
Select the time mode when the power is turned on.
- (12) Bpm Disp (BPM DISPLAY) : Disp ON* / Disp OFF
Select the BPM display
- (13) Relay Mode : Relay ON / Relay OFF* :
Relay mode on / off.
- If RELAY MODE is selected by PRESET of CD1 or CD2, RELAY MODE will be selected when the power is turned on.
- (14) Relay Time : Relay Osec* / Relay 1sec / Relay 2sec / Relay 3sec
Select the crossover time the currently playing track when the opposite drive start to play with the Relay Play function.
- (15) Memo Clear (MEMO ALL CLEAR) :
NOTE: This PRESET item can be only performed in CD1 (left side) of the remote controller.
Clear all MEMO data in the non-volatile memory.
- ① To clear all MEMO data, push the TRACK SELECT knob ⑨ down.
 - "Clear OK?" flashes on the character display.
 - ② Push the TRACK SELECT knob ⑨ down again and select "OK" to execute clearing all MEMO data.
 - "Memo Clear" is displayed on the character display while clearing.
 - ③ Once clearing is completed, "Complete!" is displayed.
- (16) Version No. The DN-D4500's software version is displayed. (SYSTEM / DSP)
- (17) Preset Int.(PRESET INITIALIZE) : Set all the preset data back to the factory defaults.
- ① To clear the PRESET data, push the TRACK SELECT knob ⑨ down.
 - "Initial OK?" flashes on the character display.
 - ② Push the TRACK SELECT knob ⑨ down again and select "OK" to start clear the preset data.
 - "Preset Int" is displayed on the character display while data clearing.
 - ③ Once clearing is completed, "Complete!" is displayed.

FRONT PANEL

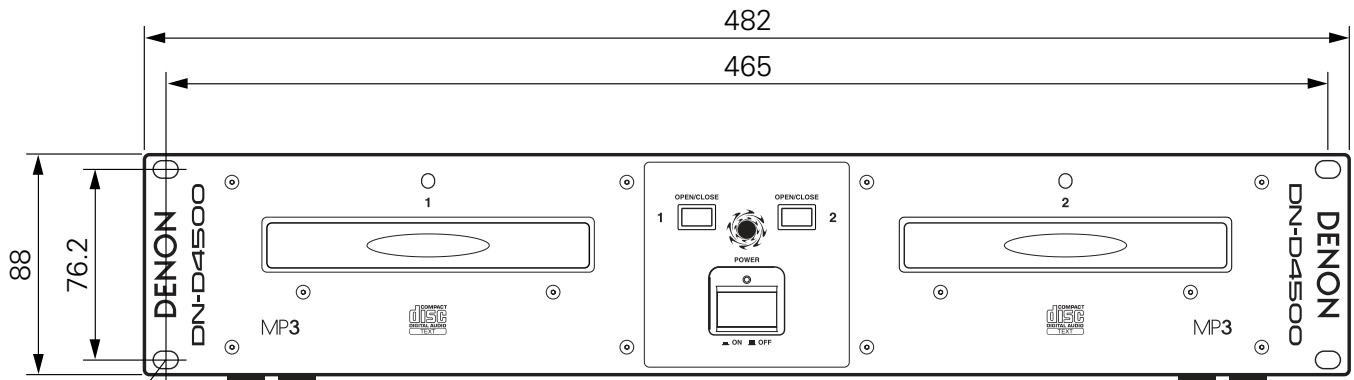

Loch 7 x 10 Foro 7x 10 Opening 7 x 10 7 x 10 孔
 Trou de 7 x 10 Orificio de 7 x 10 Hål, 7 x 10

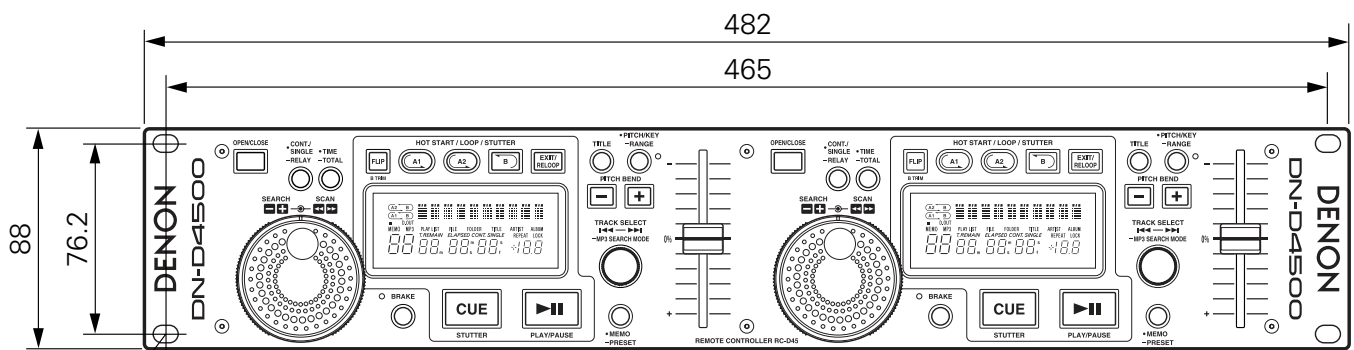

Loch 7 x 10 Foro 7 x 10 Opening 7 x 10 7 x 10 孔
 Trou de 7 x 10 Orificio de 7 x 10 Hål, 7 x 10

REAR PANEL

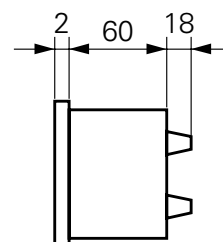
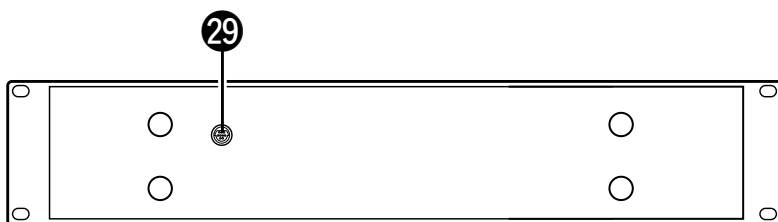
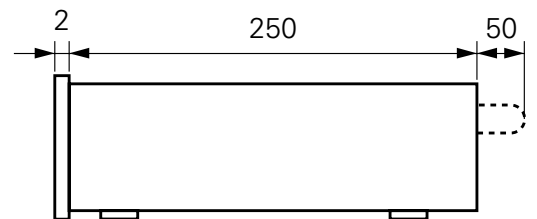
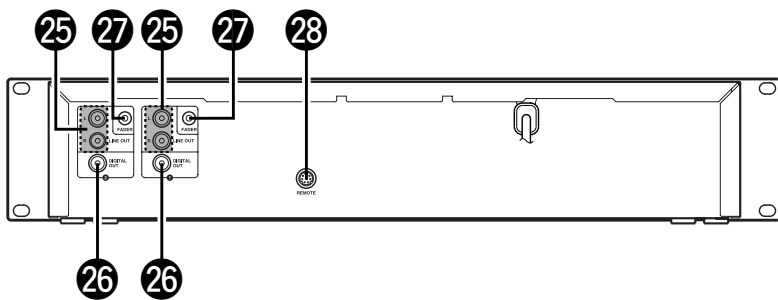

Unit: mm
 Gerät: mm
 Unité: mm
 Unità: mm
 Unidad: mm
 Eenheid: mm
 Enhet: mm
 単位: mm

12 SPECIFICATIONS

GENERAL

Type:	Compact disc player
Disc type:	Standard compact disc (12 cm disc), CD-TEXT CD-R, CD-RW discs
	NOTE: Finalized CD-R or CD-RW discs can be played back in this unit. However, according to recording quality, some CD-R/RW discs cannot be played.
Dimensions:	Player unit: 482 (W) x 88 (H) x 252 (D) mm (without feet) 18-31/32" (W) x 3-15/32" (H) x 9-59/64" (D) Remote control unit: 482 (W) x 88 (H) x 62 (D) mm (without feet) 18-31/32" (W) x 3-15/32" (H) x 2-7/16" (D)
Installation:	19-inch rack mountable Player unit: 2U Remote control unit: 2U
Mass:	Player unit: 6.2 kg (13 lbs 7 oz) Remote control unit: 1.9 kg (4 lbs 2 oz)
Power supply:	U.S.A., Canada and Taiwan R.O.C. models: 120 V AC $\pm 10\%$, 60 Hz European models: 230 V AC $\pm 10\%$, 50 Hz
Power consumption:	19 W
Environmental conditions:	Operational temperature: 5 to 35°C (41 to 95°F) Operational humidity: 25 to 85% (no condensation) Storage temperature: -20 to 60°C (-4 to 140°F)

AUDIO SECTION

Main out, Monitor out

Quantization:	16-bit linear per channel
Sampling frequency:	44.1 kHz at normal pitch
Oversampling rate:	8 times
Total harmonic distortion:	0.01% or less
Signal to noise ratio:	90 dB or more
Channel separation:	85 dB or more
Frequency response:	20 to 20,000 Hz
Analog output	
Output level:	2.0 V r.m.s.
Load impedance:	10 k Ω /kohms or more
Digital output	
Signal format:	IEC958-Type2
Output level:	0.5 Vp-p 75 Ω /ohms

FUNCTIONS

Instant start:	Within 20 msec.
Variable pitch:	$\pm 4\%$ (0.1% pitch), $\pm 10\%$ (0.1% pitch), $\pm 16\%$ (0.1% pitch) $\pm 24\%$ (1.0% pitch), $\pm 50\%$ (1.0% pitch), $\pm 100\%$ (1.0% pitch)
Pitch bend:	Pitch range $\pm 4\% \sim \pm 24\%$: $\pm 32\%$ Pitch range $\pm 50\%$, $\pm 100\%$: $\pm 99\%$
Search precision:	1/75 sec. (1 subcode frame)
Max. scan speed:	Over 20 times normal speed
Max. MEMO memory steps:	1000 steps

* Specifications and design are subject to change without notice for purpose of improvement.

D&M Holdings Inc.
PROFESSIONAL BUSINESS COMPANY

7-35-1 Sagamiono, Sagamihara-shi, Kanagawa 228-8505, JAPAN