

LCD Projector

CP-X2542WN/CP-X3042WN/CP-X4042WN
CP-WX3042WN/CP-WX4042WN

User's Manual (detailed)
Operating Guide

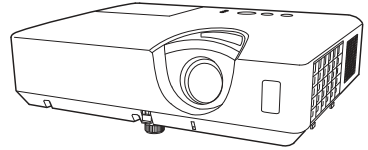

Thank you for purchasing this projector.

⚠ WARNING ▶ Before using this product, please read all manuals for this product. Be sure to read **Safety Guide** first. After reading them, store them in a safe place for future reference.

About this manual

Various symbols are used in this manual. The meanings of these symbols are described below.

⚠ WARNING This symbol indicates information that, if ignored, could possibly result in personal injury or even death due to incorrect handling.

⚠ CAUTION This symbol indicates information that, if ignored, could possibly result in personal injury or physical damage due to incorrect handling.

NOTICE This entry notices of fear of causing trouble.



Please refer to the pages written following this symbol.

NOTE • The information in this manual is subject to change without notice.
• The illustrations in this manual are for illustrative purposes. They may differ slightly from your projector.
• The manufacturer assumes no responsibility for any errors that may appear in this manual.
• The reproduction, transfer or copy of all or any part of this document is not permitted without express written consent.

Trademark acknowledgment

- Mac[®] is a registered trademark of Apple Inc.
- Windows[®], DirectDraw[®] and Direct3D[®] are registered trademarks of Microsoft Corporation in the U.S. and/or other countries.
- VESA and DDC are trademarks of the Video Electronics Standard Association.
- HDMI, the HDMI logo, and High-Definition Multimedia Interface are trademarks or registered trademarks of HDMI Licensing LLC in the United States and other countries.
- Blu-ray Disc[™] and Blu-ray[™] are trademarks of Blu-ray Disc Association.
- MHL[®], the MHL logo, and Mobile High-Definition Link are trademarks or registered trademarks of MHL, LLC in the United States and other countries.

All other trademarks are the properties of their respective owners.

Contents



Introduction	3
Features	3
Checking the contents of package	3
Part names	4
Setting up	7
Arrangement	7
Connecting with your devices	10
Connecting to a power supply	16
Fastening the adapter cover	17
Using the security bar and slot	17
Remote control	18
Installing the batteries	18
About the remote control signal	19
Changing the frequency of remote control signal	19
Using as a simple PC mouse & keyboard	20
Power on/off	21
Turning on the power	21
Turning off the power	22
Operating	23
Adjusting the volume	23
Temporarily muting the sound	23
Selecting an input signal	24
Searching an input signal	25
Selecting an aspect ratio	26
Adjusting the projector's elevator	27
Adjusting the zoom and focus	27
Using the automatic adjustment feature	28
Adjusting the position	28
Correcting the keystone/perfect fit distortions	29
Using the magnify feature	30
Temporarily freezing the screen	31
Temporarily blanking the screen	31
Using the menu function	32
EASY MENU	34
ASPECT, AUTO KEYSTONE, KEYSTONE, KEYSTONE, PERFECT FIT, PICTURE MODE, ECO MODE, INSTALLATION, RESET, FILTER TIME, LANGUAGE, ADVANCED MENU, EXIT	
PICTURE menu	36
BRIGHTNESS, CONTRAST, HDR, ACCENTUALIZER, GAMMA, COLOR TEMP, COLOR, TINT, SHARPNESS, ACTIVE IRIS, MY MEMORY	
IMAGE menu	40
ASPECT, OVER SCAN, V POSITION, H POSITION, H PHASE, H SIZE, AUTO ADJUST EXECUTE	
INPUT menu	43
PROGRESSIVE, VIDEO NR, COLOR SPACE, VIDEO FORMAT, DIGITAL FORMAT, DIGITAL RANGE,	



COMPUTER IN, FRAME LOCK, RESOLUTION, MHL STANDBY PWR.	
SETUP menu	47
AUTO KEYSTONE, KEYSTONE, KEYSTONE, PERFECT FIT, LAMP & FILTER, IMAGE OPTIMIZER, INSTALLATION, STANDBY MODE	
AUDIO menu	52
VOLUME, SPEAKER, AUDIO SOURCE, MIC LEVEL, MIC VOLUME	
SCREEN menu	53
LANGUAGE, MENU POSITION, BLANK, AUTO BLANK, START UP, MyScreen, MyScreen Lock, MESSAGE, SOURCE NAME, TEMPLATE, C.C.	
OPTION menu	59
AUTO SEARCH, AUTO KEYSTONE, DIRECT POWER ON, AUTO POWER OFF, MY BUTTON, MY SOURCE, SCHEDULE, SERVICE	
NETWORK menu	73
SECURITY menu	74
SECURITY PASSWORD CHANGE, MyScreen PASSWORD, PIN LOCK, TRANSITION DETECTOR, MY TEXT PASSWORD, MY TEXT DISPLAY, MY TEXT WRITING, CLONING LOCK	
Presentation tools	80
PC-LESS Presentation	80
USB Display(Windows computer)	90
USB Display(Mac computer)	94
Maintenance	98
Replacing the lamp	98
Cleaning and replacing the air filter	100
Other care	102
Troubleshooting	103
Related messages	103
Regarding the indicator lamps	105
Resetting all settings	108
Phenomena that may be easy to be mistaken for machine defects	108
Specifications	113

Introduction

Features

The projector provides you with the broad use by the following features.

- ✓ This projector has a variety of I/O ports that supposedly cover for any business scene. An HDMI™ port can support various image equipment which have digital interface to get clearer pictures on a screen. This model has two HDMI™ ports.
- ✓ If you insert a USB storage device, such as a USB memory, into the **USB TYPE A** port and select the port as the input source, you can view images stored in the device.
- ✓ This projector can be controlled and monitored via LAN connection. Furthermore, you can use the designated USB wireless adapter (optional) to establish wireless LAN connection.
- ✓ The built-in 16W speaker can deliver sufficient sound volume in a large space like a classroom without external speakers.
- ✓ Has an HDCR and an ACCENTUALIZER features which are Hitachi's original image stabilizer for a clearer image.
- ✓ Equipped with IMAGE OPTIMIZER which is Hitachi's original function to maintain visibility by automatic image correction in accordance with lamp deterioration.

Checking the contents of package

Please see the **Contents of package** section in the **User's Manual (concise)** which is a book. Your projector should come with the items shown there. Require of your dealer immediately if any items are missing.

⚠ WARNING ► Keep small parts away from children and pets. Take care not to put in the mouth. If swallowed, consult a physician immediately for emergency treatment.

NOTE • Keep the original packing materials, for future reshipment. Be sure to use the original packing materials when moving the projector. Use special caution for the lens.
• The projector may make a rattling sound when tilted, moved or shaken, since a flap to control the air flow inside of the projector has moved. Be aware that this is not a failure or malfunction.

Part names

- (1) Lamp cover (📖98)
The lamp unit is inside.
- (2) Speaker (📖23, 52)
- (3) Filter cover (📖100)
The air filter and intake vent are inside.
- (4) Elevator feet (x2) (📖27)
- (5) Elevator button (📖27)
- (6) Remote sensor (📖19)
- (7) Lens (📖102)
- (8) Lens cover
- (9) Intake vents
- (10) Control panel (📖5)
- (11) **FOCUS** ring (📖27)
- (12) **ZOOM** ring (📖27)
- (13) **AC** (AC inlet) (📖16)
- (14) Exhaust vent
- (15) Rear panel (📖5)

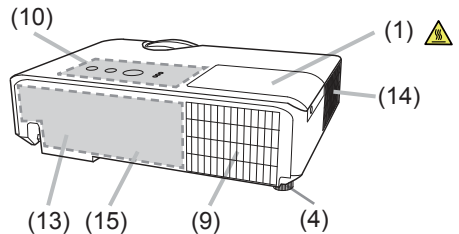
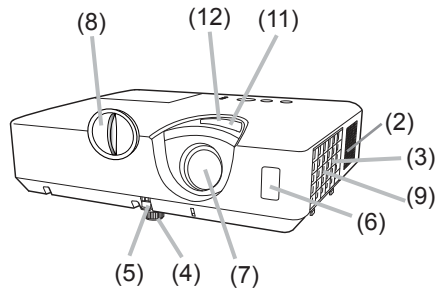

⚠ WARNING ▶ Do not open or remove any portion of the product, unless the manuals direct it.

- ▶ Do not subject the projector to unstable conditions.
- ▶ Do not apply a shock or pressure to this product.
- ▶ Do not look into the lens and the openings on the projector while the lamp is on, since the projection ray may cause a trouble on your eyes.
- ▶ Keep any object away from concentrated projection light beam. Blocking the beam by something causes high temperature and could result in fire or smoke.

⚠ CAUTION ▶ Do not touch around the lamp cover and the exhaust vents during use or just after use, since it is too hot.

- ▶ Do not attach anything onto the lens because it could damage the lens, such as melting the lens.
- ▶ Do not attach anything onto the lens except the lens cover of this projector because it could damage the lens, such as melting the lens.



(continued on next page)

Part names (continued)

Control panel

- (1) **STANDBY/ON** button (📖21)
- (2) **INPUT** button (📖24)
- (3) **MENU** button (📖32)
- (4) **LAMP** indicator (📖105)
- (5) **TEMP** indicator (📖105)
- (6) **POWER** indicator (📖105)

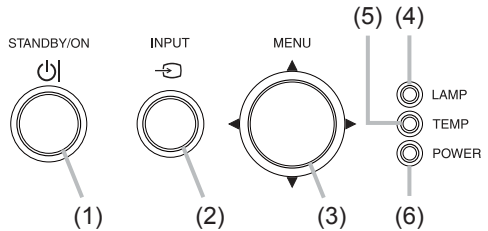

Rear panel (📖10 ~ 15)

- | | |
|----------------------------------|---|
| (1) LAN port | (11) COMPUTER IN2 / MONITOR OUT port |
| (2) USB TYPE A port (x2) | (12) CONTROL port |
| (3) USB TYPE B port | (13) VIDEO port |
| (4) HDMI1 port | (14) Security slot (📖17) |
| (5) MIC port (📖15) | (15) Security bar (📖17) |
| (6) AUDIO IN1 port | (16) HDMI2/MHL port |
| (7) AUDIO IN2 port | |
| (8) AUDIO IN3 (R,L) ports | |
| (9) AUDIO OUT port | |
| (10) COMPUTER IN1 port | |

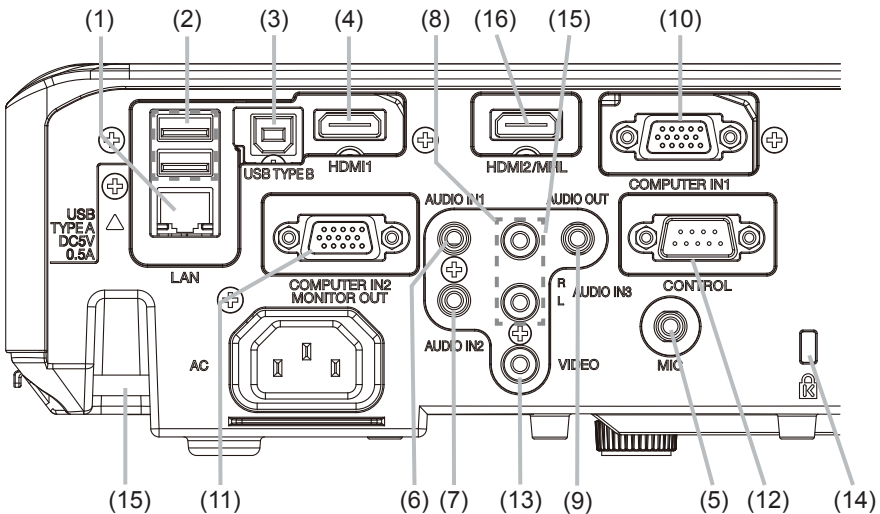

(continued on next page)

Part names (continued)

Remote control

- (1) **VIDEO** button (📖24)
- (2) **COMPUTER** button (📖24)
- (3) **SEARCH** button (📖25)
- (4) **STANDBY/ON** button (📖21)
- (5) **ASPECT** button (📖26)
- (6) **AUTO** button (📖28)
- (7) **BLANK** button (📖31)
- (8) **MAGNIFY - ON** button (📖30)
- (9) **MAGNIFY - OFF** button (📖30)
- (10) **MY SOURCE/DOC.CAMERA** button (📖25, 62)
- (11) **VOLUME -** button (📖23)
- (12) **PAGE UP** button (📖20)
- (13) **PAGE DOWN** button (📖20)
- (14) **VOLUME +** button (📖23)
- (15) **MUTE** button (📖23)
- (16) **FREEZE** button (📖31)
- (17) **MY BUTTON - 1** button (📖61, 62)
- (18) **MY BUTTON - 2** button (📖61, 62)
- (19) **KEystone** button (📖29)
- (20) **POSITION** button (📖28, 32)
- (21) **MENU** button (📖32)
- (22) **▲/▼/◀/▶** cursor buttons (📖32)
- (23) **ENTER** button (📖32)
- (24) **ESC** button (📖32)
- (25) **RESET** button (📖32)
- (26) Battery cover (📖18)

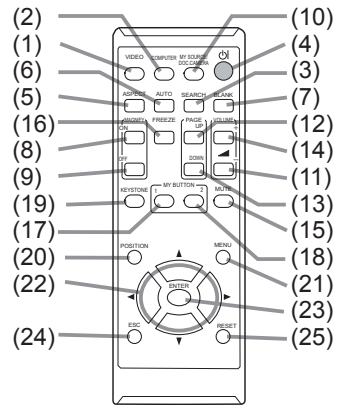

Back of
the remote control

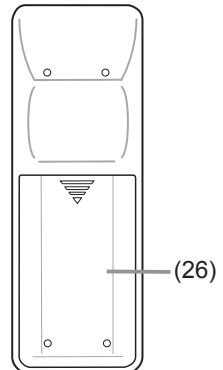

Setting up

Install the projector according to the environment and manner the projector will be used in.

For the case of installation in a special state such as ceiling mount, the specified mounting accessories ([☐ Specifications](#) in the **User's Manual (concise)**) and service may be required. Before installing the projector, consult your dealer about your installation.

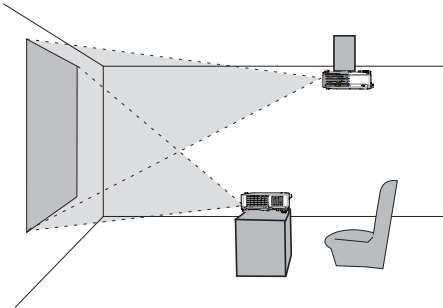

Arrangement

Refer to tables T-1 to T-4 and figures F-1 and F-2 at the end of User's Manual (concise) to determine the screen size and projection distance.

The values shown in the table are calculated for a full size screen.

- (a) Screen size (diagonal)
- (b) Projection distance ($\pm 10\%$, from the projector's end)
- (c1), (c2) Screen height ($\pm 10\%$)

- If the projector is used at an altitude of about 1600 m (5250 feet) or higher, set ALTITUDE of the SERVICE item in the OPTION menu to HIGH ([☐ 66](#)). Otherwise, set it to NORMAL. If the projector is used with a wrong setting, it may cause damage to the projector itself or the parts inside.

NOTE • The screen position may shift after installation if the projector is suspended from the ceiling or other location due to the flexibility of the plastic projector body. If readjustment is necessary, consult with your dealer or service personnel.

(continued on next page)

Arrangement (continued)

⚠ WARNING ▶ Install the projector where you can access the power outlet easily. If an abnormality should occur, unplug the projector urgently. Otherwise it could cause a fire or electric shock.

▶ Do not subject the projector to unstable conditions. If the projector falls or topples over, it could result in injury or damage to the projector and the surrounding things. Using a damaged projector could result in a fire and an electric shock.

- Do not place the projector in unstable places, such as an inclined surface, places subject to vibration, on top of a wobbly table or cart, or a surface that is smaller than the projector.
- Do not put the projector on its side, front or rear position.
- Do not attach nor place anything on the projector unless otherwise specified in the manual.
- Do not use any mounting accessories except the accessories specified by the manufacturer. Read and keep the manuals of the accessories used.
- For special installation such as ceiling mounting, be sure to consult your dealer beforehand.

▶ Do not install the projector near thermally conductive or flammable things. Such things when heated by the projector could result in a fire and burns.

- Do not place the projector on a metal stand.

▶ Do not place the projector where any oils, such as cooking or machine oil, are used. Oil may harm the product, resulting in malfunction, or falling from the mounted position.

▶ Do not place the projector in a place where it may get wet. Getting the projector wet or inserting liquid into the projector could cause a fire and an electric shock, and damage the projector.

- Do not place the projector near water, such as in a bathroom, kitchen, or poolside.
- Do not place the projector outdoors or by the window.
- Do not place anything containing liquid near the projector.

(continued on next page)

Arrangement (continued)

⚠ CAUTION ▶ Place the projector in a cool place with sufficient ventilation. The projector may shutdown automatically or may malfunction if its internal temperature is too high.

Using a damaged projector could result in a fire and an electric shock.

- Do not place the projector in direct sunlight or near hot objects such as heaters.
- Do not place the projector where the air from an air conditioner or similar unit will blow on it directly.
- Keep a space of 30 cm or more between a side of the projector and other objects such as walls.
- Do not place the projector on carpet, cushions or bedding.
- Do not stop up, block nor cover the projector's vent holes. Do not place anything around the projector that could be sucked in or stuck to the projector's intake vents.
- Do not place the projector at places that are exposed to magnetic fields, doing so can cause the cooling fans inside the projector to malfunction.

▶ Avoid placing the projector in smoky, humid or dusty place. Placing the projector in such places could cause a fire, an electric shock and malfunction of the projector.

- Do not place the projector near humidifiers. Especially for an ultrasonic humidifier, chlorine and minerals contained in tap water are atomized and could be deposited in the projector causing image degradation or other problems.

NOTICE • Do not place the projector in a smoking area, kitchen, passageway or by the window.

- Position the projector to prevent light from directly hitting the projector's remote sensor.
- Do not place the product in a place where radio interference may be caused.
- Check and correct the setting for ALTITUDE of SERVICE in the OPTION menu according to the usage environment ( 66). If the projector is used with a wrong setting, it may cause damage to the projector itself or the parts inside.
- Keep heat-sensitive things away from the projector. Otherwise, they may be damaged by the heat from the projector.

Connecting with your devices

Before connecting the projector to a device, consult the manual of the device to confirm that the device is suitable for connecting with this projector and prepare the required accessories, such as a cable in accord with the signal of the device. Consult your dealer when the required accessory did not come with the product or the accessory is damaged.

After making sure that the projector and the devices are turned off, perform the connection, according to the following instructions. Refer to the figures in subsequent pages.

Before connecting the projector to a network system, be sure to read **Network Guide** too.

⚠ WARNING ► **Use only the appropriate accessories.** Otherwise it could cause a fire or damage the projector and devices.

- Use only the accessories specified or recommended by the projector's manufacturer. It may be regulated under some standard.
- Neither disassemble nor modify the projector and the accessories.
- Do not use the damaged accessory. Be careful not to damage the accessories. Route a cable so that it is neither stepped on nor pinched out.

⚠ CAUTION ► **For a cable with a core at only one end, connect the end with the core to the projector.** That may be required by EMI regulations.

NOTE • Do not turn on or off the projector while connected to a device in operation, unless that is directed in the manual of the device. Otherwise it may cause malfunction in the device or projector.

- The function of some input ports can be selected according to your usage requirements. Check the reference page indicated beside each port in the following illustration.
- Be careful not to mistakenly connect a connector to a wrong port. Otherwise it may cause malfunction in the device or projector.
 - When connecting a connector to a port, make sure that the shape of the connector fits the port.
 - Tighten the screws to connect a connector equipped with screws to a port.
 - Use the cables with straight plugs, not L-shaped ones, as the input ports of the projector are recessed.

(continued on next page)

Connecting with your devices (continued)

About Plug-and-Play capability

- Plug-and-Play is a system composed of a computer, its operating system and peripheral equipment (i.e. display devices). This projector is VESA DDC 2B compatible. Plug-and-Play can be used by connecting this projector to a computer that is VESA DDC (display data channel) compatible.
- Take advantage of this feature by connecting a computer cable to the **COMPUTER IN1** port (DDC 2B compatible). Plug-and-Play may not work properly if any other type of connection is attempted.
- Please use the standard drivers in your computer as this projector is a Plug-and-Play monitor.

(continued on next page)

Connecting with your devices (continued)

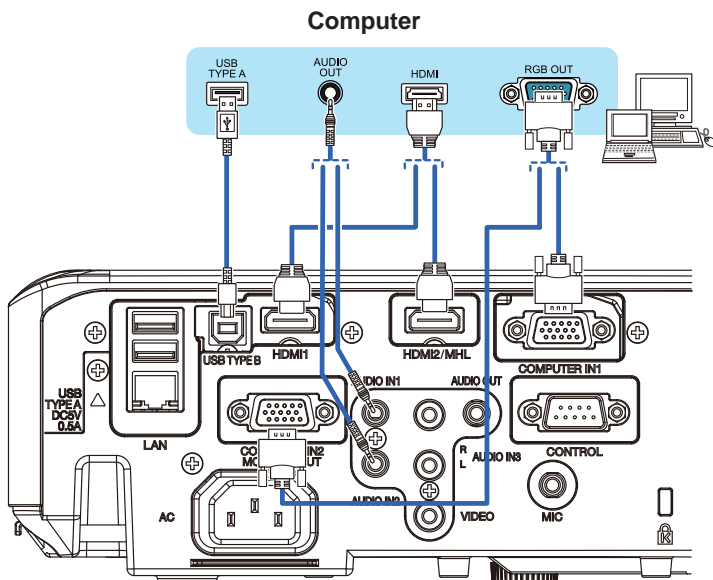

NOTE • Before connecting the projector to a computer, consult the computer's manual and check the compatibility of the signal level, the synchronization methods and the display resolution output to the projector.

- Some signal may need an adapter to input this projector.
- Some computers have multiple screen display modes that may include some signals which are not supported by this projector.
- Although the projector can display signals with resolution up to UXGA (1600x1200), the signal will be converted to the projector's panel resolution before being displayed. The best display performance will be achieved if the resolutions of the input signal and the projector panel are identical.
- If you connect this projector and a notebook computer, you need output the display to an external monitor, or output simultaneously to the internal display and an external monitor. Consult the computer's manual for the setting.
- Depending on the input signal, the automatic adjustment function of this projector may take some time and not function correctly.
- Note that a composite sync signal or sync-on-green signal may confuse the automatic adjustment function of this projector (28).
- If the automatic adjustment function does not work correctly, you may not see the dialog to set the display resolution. In such a case, use an external display device. You may be able to see the dialog and set an appropriate display resolution.

(continued on next page)

Connecting with your devices (continued)

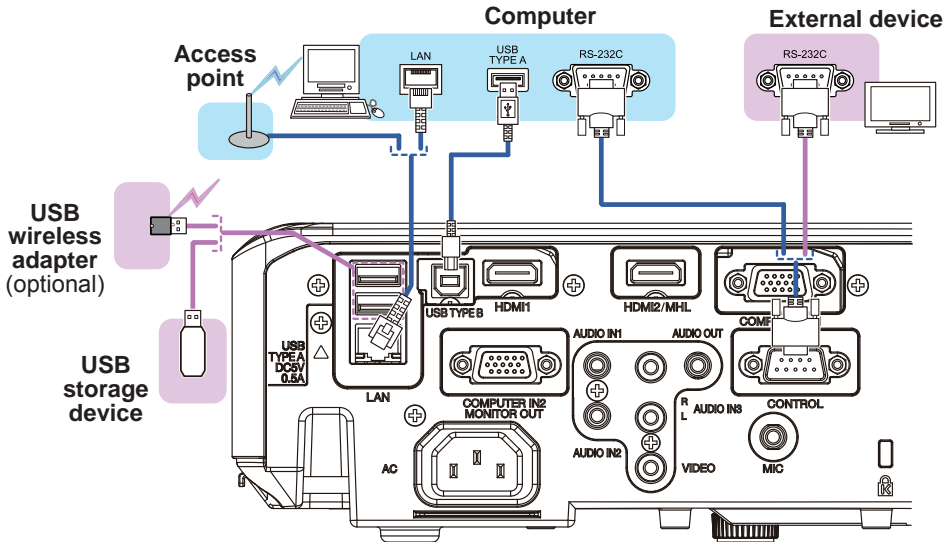

⚠ CAUTION ▶ Before connecting the projector to a network system be sure to obtain the consent of the administrator of the network.

▶ Do not connect the **LAN** port to any network that might have the excessive voltage.

▶ The designated USB wireless adapter that is sold as an option is required to use the wireless network function of this projector.

▶ Before removing the USB storage device from the port of the projector, be sure to use the REMOVE USB function on the thumbnail screen to secure your data (83).

▶ Do not use any extension cable or device when connecting the adapter to the projector. Before you insert or pull out the USB wireless adapter from the projector, turn off the power of the projector and pull out the power cord's plug from the outlet. Do not touch the USB wireless adapter while the projector is receiving AC power.

▶ To connect both the LAN cable and USB device to the projector, use a LAN cable that is flat on the side where the plug's wire is visible. Otherwise, both of them cannot be connected correctly, or the wire may break (malfunction).

NOTE • If an oversized USB storage device blocks the **LAN** port, use a USB extension cable to connect the USB storage device.

(continued on next page)

Connecting with your devices (continued)

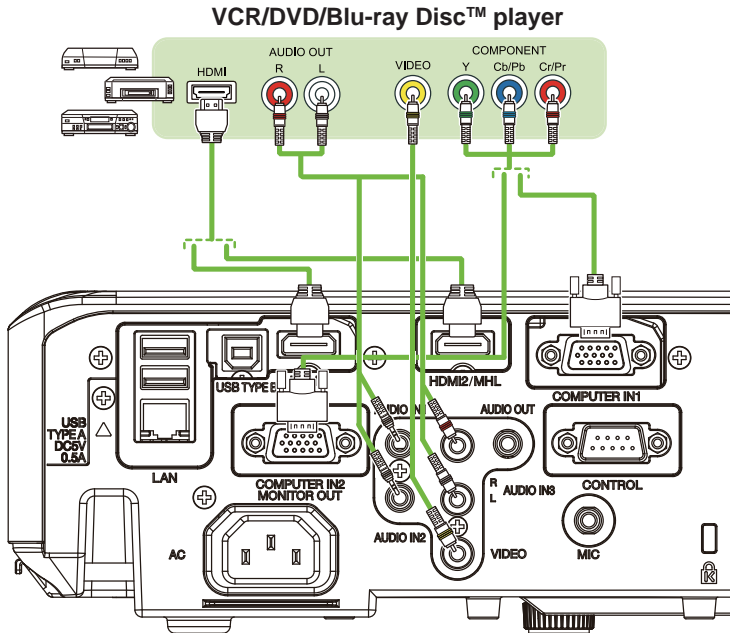

NOTE • The HDMI™ port of this model is compatible with HDCP (High-bandwidth Digital Content Protection) and therefore capable of displaying a video signal from HDCP compatible DVD players or the like.

- The HDMI™ port supports the following signals.
Video signal : 480i@60, 480p@60, 576i@50, 576p@50, 720p@50/60, 1080i@50/60, 1080p@50/60
Audio signal : Format Linear PCM
Sampling frequency 48kHz / 44.1kHz / 32kHz
- This projector can be connected with another equipment that has HDMI™ connector, but with some equipment the projector may not work properly, something like no video.
- Be sure to use an HDMI™ cable that has the HDMI™ logo.
- Use a Category 2-certified HDMI™ cable to input 1080p@50/60 signal to the projector.
- When the projector is connected with a device having DVI connector, use a DVI to HDMI™ cable to connect with the HDMI™ input.
- The MHL supports the following signals. For Video signals, refer to User's Manual (detailed) Operating Guide –Technical.
Audio signal : Format Linear PCM
Sampling frequency 48kHz / 44.1kHz / 32kHz
- Be sure to use an MHL® cable that has the MHL logo.

(continued on next page)

Connecting with your devices (continued)

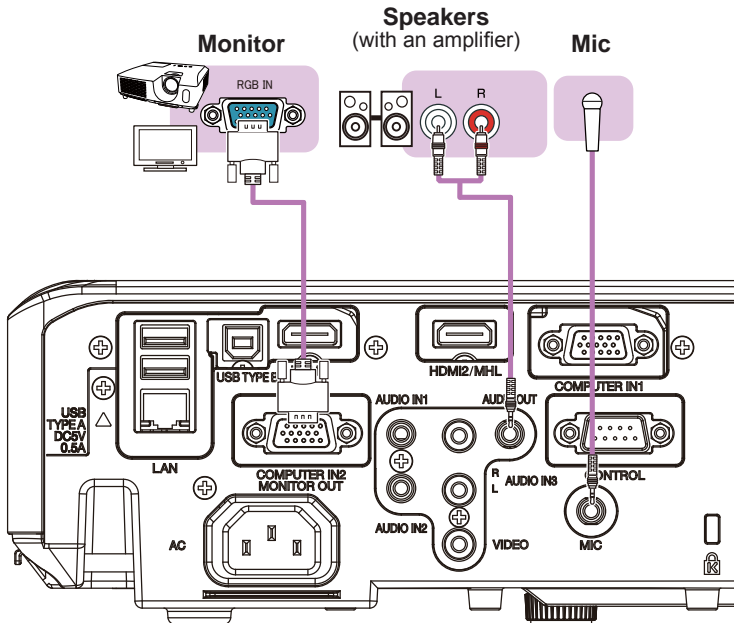

NOTE • If a loud feedback noise is produced from the speaker, move the microphone away from the speaker.

Microphone function

- You can connect a dynamic microphone to the **MIC** port with a 3.5 mm mini-plug. In that case, the built-in speaker outputs the sound from the microphone, even while the sound from the projector is output. You can input line level signal to the **MIC** port from equipment such as wireless microphone. Select HIGH in the MIC LEVEL item of the AUDIO menu when you input line level audio signal to the **MIC** port. In the normal mode, the volume of the microphone can be adjusted separately from the volume of the projector using the menu ([52](#)). In the standby mode, the volume of the microphone is adjustable with the **VOLUME +/-** buttons on the remote control, in synchronization with the volume of the projector ([23](#)). Even when the sound of projector is set to mute mode by the AUDIO SOURCE function ([52](#)), the volume of the microphone is adjustable.
- In both modes (standby or normal), the **MUTE** button on the remote control works on the sounds of the microphone and the projector ([23](#)).
- This projector doesn't support plug-in power for the microphone.

Connecting to a power supply

1. Put the connector of the power cord into the **AC** (AC inlet) of the projector.
2. Firmly plug the power cord's plug into the outlet. In a couple of seconds after the power supply connection, the **POWER** indicator will light up in steady orange.

Please remember that when the DIRECT POWER ON function activated (📖59), the connection of the power supply make the projector turn on.

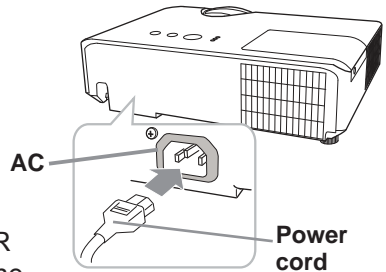

⚠ WARNING ► Please use extra caution when connecting the power cord, as incorrect or faulty connections may result in fire and/or electrical shock.

- Do not touch the power cord with a wet hand.
- Only use the power cord that came with the projector. If it is damaged, consult your dealer to get a new one. Never modify the power cord.
- Only plug the power cord into an outlet whose voltage is matched to the power cord. The power outlet should be close to the projector and easily accessible. Remove the power cord for complete separation.
- Do not distribute the power supply to multiple devices. Doing so may overload the outlet and connectors, loosen the connection, or result in fire, electric shock or other accidents.
- Connect the ground terminal for the AC inlet of this unit to the ground terminal of the building using an appropriate power cord (bundled).

NOTICE ► This product is also designed for IT power systems with a phase-to-phase voltage of 220 to 240 V.

Fastening the adapter cover

Use the supplied adapter cover to prevent the USB wireless adapter from coming off easily.

1. Loosen the screw (marked with triangle) on the bottom left of the **USB TYPE A** port.
2. Insert the tab of the cover into the hole at the upper right of the **USB TYPE A** port in the direction of the arrow.
3. Align the screw holes on the projector and the cover. Then insert the screw removed from the projector into the hole and tighten the screw.

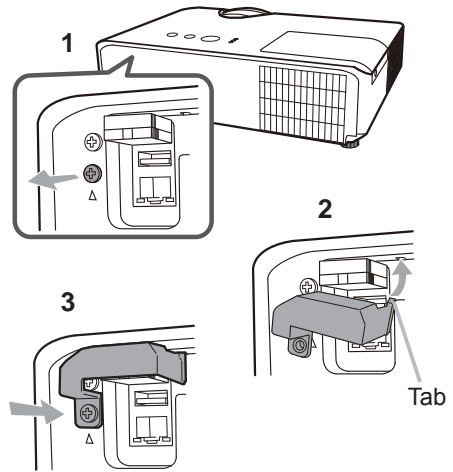

⚠ WARNING ▶ Keep small parts away from children and pets. Take care not to put in the mouth.

Using the security bar and slot

A commercially available anti-theft chain or wire can be attached to the security bar on the projector. Refer to the figure to choose an anti-theft chain or wire.

Also this product has the security slot for the Kensington lock.

For details, see the manual of the security tool.

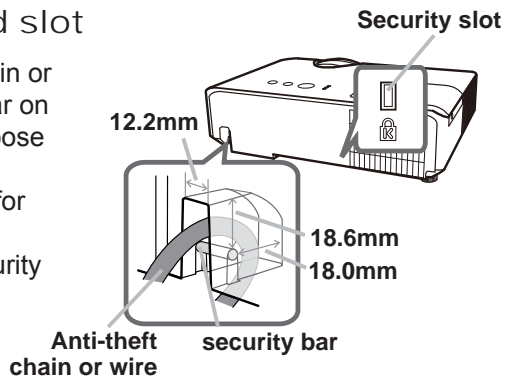

⚠ WARNING ▶ Do not use the security bar and slot to prevent the projector from falling down, since it is not designed for it.

⚠ CAUTION ▶ Do not place anti-theft chain or wire near the exhaust vents. It may become too hot.

NOTE • The security bar and slot is not comprehensive theft prevention measures. It is intended to be used as supplemental theft prevention measure.

Remote control

Installing the batteries

Please insert the batteries into the remote control before using it. If the remote control starts to malfunction, try to replace the batteries. If you will not use the remote control for long period, remove the batteries from the remote control and store them in a safe place.

1. Remove the battery cover.
2. Align and insert the two AA batteries (Use the appropriate AA carbon-zinc or alkaline batteries (non-rechargeable) in accordance with laws and regulations.) according to their plus and minus terminals as indicated in the remote control.
3. Put the battery cover back to the former state.

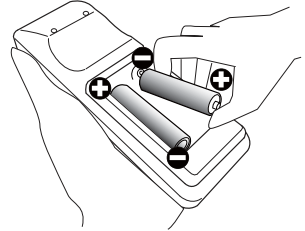

- ⚠ WARNING** ► Always handle the batteries with care and use them only as directed. Improper use may result in battery explosion, cracking or leakage, which could result in fire, injury and/or pollution of the surrounding environment.
- Be sure to use only the batteries specified. Do not use batteries of different types at the same time. Do not mix a new battery with used one.
 - Make sure the plus and minus terminals are correctly aligned when loading a battery.
 - Keep a battery away from children and pets.
 - Do not recharge, short circuit, solder or disassemble a battery.
 - Do not place a battery in a fire or water. Keep batteries in a dark, cool and dry place.
 - If you observe battery leakage, wipe out the leakage and then replace a battery. If the leakage adheres to your body or clothes, rinse well with water immediately.
 - Obey the local laws on disposing the battery.

About the remote control signal

The remote control works with the projector's remote sensor. This projector has a remote sensor on the front. The sensor senses the signal within the following range when the sensor is active:

- 60 degrees (30 degrees to the left and right of the sensor)
- within 3 meters about.

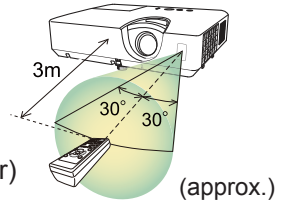

NOTE

- The remote control signal reflected in the screen or the like may be available. If it is difficult to send the signal to the sensor directly, attempt to make the signal reflect.
- The remote control uses infrared light to send signals to the projector (Class 1 LED), so be sure to use the remote control in an area free from obstacles that could block the remote control's signal to the projector.
- The remote control may not work correctly if strong light (such as direct sun light) or light from an extremely close range (such as from an inverter fluorescent lamp) shines on the remote sensor of the projector. Adjust the position of projector avoiding those lights.

Changing the frequency of remote control signal

The accessory remote control has the two choices on signal frequency Mode 1:NORMAL and Mode 2:HIGH. If the remote control does not function properly, attempt to change the signal frequency. In order to set the Mode, please keep pressing the combination of two buttons listed below simultaneously for about 3 seconds.

- (1) Set to Mode 1:NORMAL... **VOLUME -** and **RESET** buttons
- (2) Set to Mode 2:HIGH... **MAGNIFY OFF** and **ESC** buttons

Please remember that the REMOTE_FREQ. in the SERVICE item of the OPTION menu (📖 67) of the projector to be controlled should be set to the same mode as the remote control.

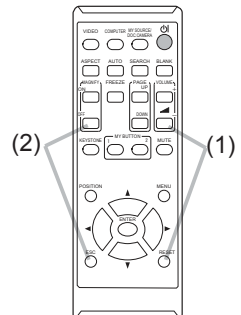

Using as a simple PC mouse & keyboard

The accessory remote control works as a simple mouse and keyboard of the computer, when the projector's **USB TYPE B** port and the computer's type A USB port are connected.

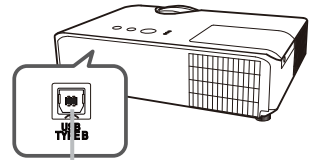

- (1) **PAGE UP key:** Press **PAGE UP** button.
- (2) **PAGE DOWN key:** Press **PAGE DOWN** button.
- (3) **Mouse left button:** Press **ENTER** button.
- (4) **Move pointer:** Use the cursor buttons **▲**, **▼**, **◀** and **▶**.
- (5) **ESC key:** Press **ESC** button.
- (6) **Mouse right button:** Press **RESET** button.

USB TYPE B port

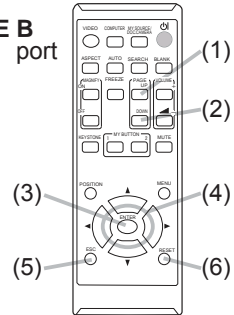

NOTICE ▶ Improper use of the simple mouse & keyboard function could damage your equipment. While using this function, please connect this product only to a computer. Be sure to check your computer's manuals before connecting this product to the computer.

NOTE When the simple mouse & keyboard function of this product does not work correctly, please check the following.

- When a USB cable connects this projector with a computer having a built-in pointing device (e.g. track ball) like a laptop computer, open BIOS setup menu, then select the external mouse and disable the built-in pointing device, because the built-in pointing device may have priority to this function.
- Windows Vista® or higher is required for this function. And also this function may not work depending on the computer's configurations and mouse drivers. This function can work with the computer which can operate general USB mouse or keyboard.
- You cannot do things like press two buttons at once (for instance, pressing two buttons at the same time to move the mouse pointer diagonally).
- This function is activated only when the projector is working properly. This function is not available in any of the following cases:
 - While the lamp is warming up. (The **POWER** indicator blinks in green.)
 - When either **USB TYPE A** port is selected.
 - While displaying **BLANK** (📄 53), **TEMPLATE** (📄 57) or **MY IMAGE** screen.
 - When any menu is displayed on the screen.
 - While using the cursor buttons to operate the sound or screen functions such as adjusting the sound volume, correcting the keystone, correcting the picture position and magnifying the screen.

Power on/off

Turning on the power

1. Make sure that the power cord is firmly and correctly connected to the projector and the outlet.
2. Make sure that the **POWER** indicator is steady orange (📖105). Then remove the lens cover.
3. Press **STANDBY/ON** button on the projector or the remote control.
The projection lamp will light up and **POWER** indicator will begin blinking in green. When the power is completely on, the indicator will stop blinking and light in steady green (📖105).

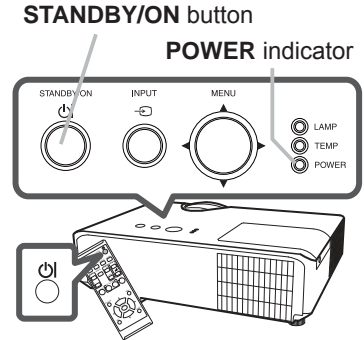

To display the picture, select an input signal according to the section **Selecting an input signal** (📖24).

The INITIAL SETTING Menu will be displayed by factory default upon startup. Once the INITIAL SETTING Menu is set, it will not appear until **FACTORY RESET** (📖72) is executed. If you wish to change the settings, refer to the **LANGUAGE** (📖53) and **ALTITUDE** (📖66) menu.

- (1) **LANGUAGE**: Use the ▲/▼/◀/▶ buttons to select the desired language and press the **ENTER** button of the remote control or the **INPUT** button of the projector to execute.



- (2) **ALTITUDE**: Use the ▲/▼ buttons to select **NORMAL** for altitude below 1600 m (5250 feet), otherwise select **HIGH** and press the **ENTER** button of the remote control or the **INPUT** button of the projector to execute.

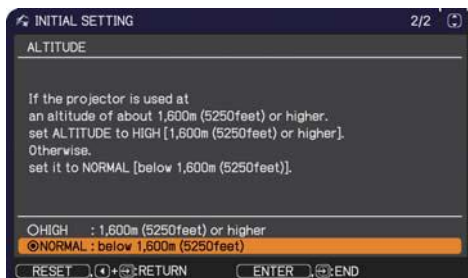

Turning off the power

1. Press the **STANDBY/ON** button on the projector or the remote control. The message “Power off?” will appear on the screen for about 5 seconds.
2. Press the **STANDBY/ON** button again while the message appears. The projector lamp will go off, and the **POWER** indicator will begin blinking in orange. Then **POWER** indicator will stop blinking and light in steady orange when the lamp cooling is complete ([📖 105](#)).
3. Attach the lens cover, after the **POWER** indicator turns in steady orange.

Do not turn the projector on for about 10 minutes or more after turning it off. Also, do not turn the projector off shortly after turning it on. Such operations might cause the lamp to malfunction or shorten the lifetime of some parts including the lamp.

⚠ WARNING ▶ A strong light is emitted when the projector's power is on. Do not look into the lens of the projector or look inside of the projector through any of the projector's openings, since the projection ray may cause a trouble on your eyes.
▶ Do not touch around the lamp cover and the exhaust vents during use or just after use, since it is too hot.

NOTE • Turn the power on/off in right order. Please power on the projector prior to the connected devices.
• This projector has the function that can make the projector automatically turn on/off. Please refer to the **DIRECT POWER ON** ([📖 59](#)) and **AUTO POWER OFF** ([📖 60](#)) items of the **OPTION** menu.

Operating

Adjusting the volume

VOLUME +/- button

- Use the **VOLUME +/VOLUME -** buttons to adjust the volume.
 - A dialog will appear on the screen to aid you in adjusting the volume. If you do not do anything, the dialog will automatically disappear after ten seconds.
 - When \times is selected for current picture input port, the volume adjustment is disabled. Please see **AUDIO SOURCE** item of **AUDIO** menu (📖 52).
 - Even if the projector is in the standby mode, the volume is adjustable when both of the following conditions are true:
 - An option other than \times is selected for **STANDBY** in the **AUDIO SOURCE** item of the **AUDIO** menu (📖 52).
 - NORMAL** is selected in the **STANDBY MODE** item of the **SETUP** menu (📖 51).
 - In the standby mode, the volume of the microphone is adjustable with the **VOLUME +/-** buttons on the remote control, in synchronization with the volume of the projector.

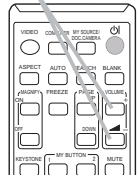

Temporarily muting the sound

MUTE button

- Press **MUTE** button on the remote control.
 - A dialog will appear on the screen indicating that you have muted the sound. To restore the sound, press the **MUTE**, **VOLUME +** or **VOLUME -** button. Even if you do not do anything, the dialog will automatically disappear after ten seconds.
 - When \times is selected for current picture input port, the sound is always muted. Please see **AUDIO SOURCE** item of **AUDIO** menu (📖 52).
 - C.C. (Closed Caption) is automatically activated when sound is muted and an input signal containing C.C. is received. This function is available only when the signal is NTSC for **VIDEO** or 480i@60 for **COMPUTER IN1** or **COMPUTER IN2**, and when **AUTO** is selected for **DISPLAY** in the **C.C.** menu under the **SCREEN** menu (📖 58).

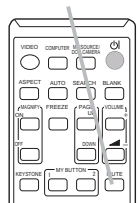

Selecting an input signal

1. Press **INPUT** button on the projector.
 - Each time you press the button, the projector switches its input port from the current port as below.

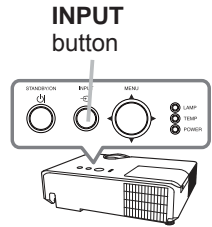
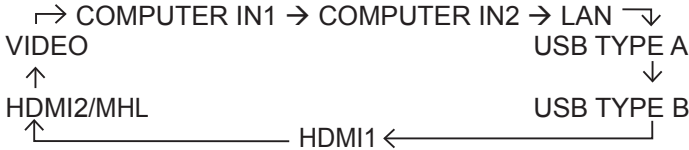

- While ON is selected for AUTO SEARCH item in OPTION menu (59), the projector will keep checking the ports in above order repeatedly till an input signal is detected.
- It may take several seconds to project the images from the **USB TYPE B** port.

1. Press **COMPUTER** button on the remote control.
 - Each time you press the button, the projector switches its input port from the current port as below.



COMPUTER button

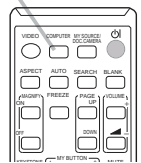

- While ON is selected for AUTO SEARCH item in OPTION menu, the projector will keep checking every port sequentially till an input signal is detected (59). If **COMPUTER** button is pressed when **VIDEO**, **HDMI1** or **HDMI2/MHL** port is selected, the projector will check **COMPUTER IN1** port first.
- It may take several seconds to project the images from the **USB TYPE B** port.

1. Press **VIDEO** button on the remote control.
 - Each time you press the button, the projector switches its input port from the current port as below.



VIDEO button

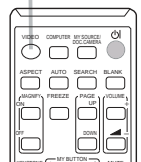

- While ON is selected for AUTO SEARCH item in OPTION menu, the projector will keep checking every port sequentially till an input signal is detected (59). If **VIDEO** button is pressed when **COMPUTER IN1**, **COMPUTER IN2**, **LAN**, **USB TYPE A** or **USB TYPE B** port is selected, the projector will check **HDMI1** port first.

Selecting an input signal(continued)

1. Press the **MY SOURCE / DOC. CAMERA** button on the remote control. The input signal will be changed into the signal you set as MY SOURCE ([📖 62](#)).
 - This function also can use for document camera. Select the input port that connected the document camera.

MY SOURCE / DOC. CAMERA button

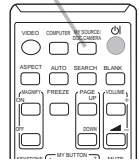

Searching an input signal

1. Press **SEARCH** button on the remote control.
 - The projector will start to check its input ports as below in order to find any input signals. When input signal is detected, the projector will stop searching and display the image. If no signal is found, the projector will return to the state selected before the operation.

SEARCH button

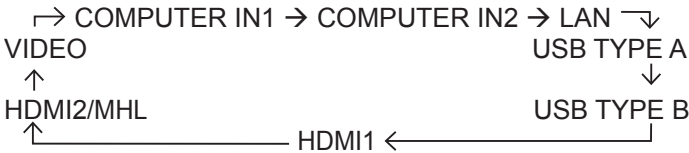
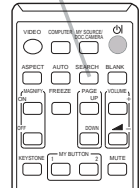

- While ON is selected for AUTO SEARCH item in OPTION menu ([📖 59](#)), the projector will keep checking the ports in above order repeatedly till an input signal is detected.
- It may take several seconds to project the images from the **USB TYPE B** port.

Selecting an aspect ratio

1. Press **ASPECT** button on the remote control.
 - Each time you press the button, the projector switches the mode for aspect ratio in turn.

ASPECT button

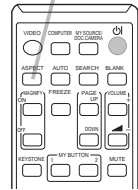

○ **For a computer signal**

CP-X2542WN/CP-X3042WN/CP-X4042WN:

NORMAL → 4:3 → 16:9 → 16:10 → ZOOM



CP-WX3042WN/CP-WX4042WN:

NORMAL → 4:3 → 16:9 → 16:10 → ZOOM → NATIVE



○ **For an HDMI™ or MHL® signal**

CP-X2542WN/CP-X3042WN/CP-X4042WN:

NORMAL → 4:3 → 16:9 → 16:10 → 14:9 → ZOOM



CP-WX3042WN/CP-WX4042WN:

NORMAL → 4:3 → 16:9 → 16:10 → 14:9 → ZOOM → NATIVE



○ **For a video signal or component video signal**

CP-X2542WN/CP-X3042WN/CP-X4042WN:

4:3 → 16:9 → 14:9 → ZOOM



CP-WX3042WN/CP-WX4042WN:

4:3 → 16:9 → 16:10 → 14:9 → ZOOM → NATIVE



○ **For an input signal from the LAN, USB TYPE A or USB TYPE B port, or if there is no signal**

CP-X2542WN/CP-X3042WN/CP-X4042WN: 4:3 (fixed)

CP-WX3042WN/CP-WX4042WN: 16:10 (fixed)

- **ASPECT** button does not work when no proper signal is inputted.
- **NORMAL** mode keeps the original aspect ratio setting.
- The display will be dark for a split second while switching the Aspect, but this is not a malfunction.

Adjusting the projector's elevator

<Front Foot>

Using the Front elevator foot can tilt the projector in order to project at a suitable angle to the screen, elevating the front side of the projector within 12 degrees. The elevator foot is adjustable while pushing the elevator button.

1. Holding the projector, push the elevator button to loose the elevator foot.
2. Release the elevator button in order to lock the elevator foot.
3. If necessary, the elevator foot can be manually twisted to make more precise adjustments. Hold the projector when twisting the foot.

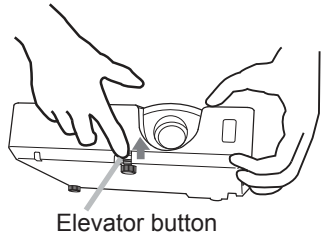

⚠ CAUTION ▶ Do not handle the elevator button without holding the projector, since the projector may drop down.
▶ Do not tilt the projector other than elevating its front within 12 degrees using the elevator foot. A tilt of the projector exceeding the restriction could cause malfunction or shortening the lifetime of consumables, or the projector itself.

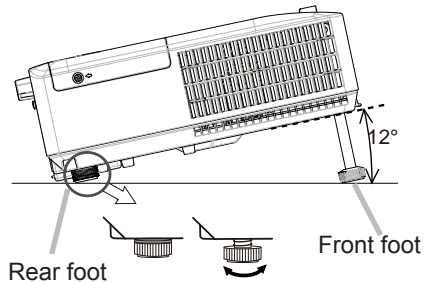

<Rear Foot>

When the place to put the projector is slightly uneven to the left or right, use the Rear elevator foot to place the projector horizontally. A spacer is installed on the Rear elevator foot at the time of shipment, and the projector is ready for use. If necessary, detach the spacer, and the elevator foot can be manually twisted to make more precise adjustments.

⚠ WARNING ▶ Keep the spacer away from children and pets. Be careful not to let them swallow the spacer. If swallowed consult a physician immediately for emergency treatment.

NOTE • After the foot is adjusted, it is possible to return it to the state of the shipment with a spacer. It is recommended to keep the spacer and reuse it when relocating the projector.

Adjusting the zoom and focus

1. Use the **ZOOM** ring to adjust the screen size.
2. Use the **FOCUS** ring to focus the picture.

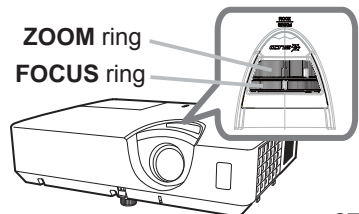

Using the automatic adjustment feature

1. Press **AUTO** button on the remote control.

AUTO button

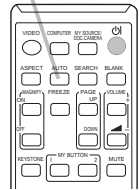

○ For a computer signal

The vertical position, the horizontal position and the horizontal phase will be automatically adjusted.

Make sure that the application window is set to its maximum size prior to attempting to use this feature. A dark picture may still be incorrectly adjusted. Use a bright picture when adjusting.

○ For a video signal

The video format best suited for the respective input signal will be selected automatically. This function is available only when the AUTO is selected for the VIDEO FORMAT item in the INPUT menu ([64](#)). The vertical position and horizontal position will be automatically set to the default.

○ For a component video signal

The vertical position and horizontal position will be automatically set to the default. The horizontal phase will be automatically adjusted.

- The automatic adjustment operation requires approx. 10 seconds. Also please note that it may not function correctly with some input.
- When this function is performed for a video signal, a certain extra such as a line may appear outside a picture.
- When this function is performed for a computer signal, a black frame may be displayed on the edge of the screen, depending on the computer model.
- The items adjusted by this function may vary when the FINE or DISABLE is selected for the AUTO ADJUST item of the SERVICE item in the OPTION menu ([66](#)).

Adjusting the position

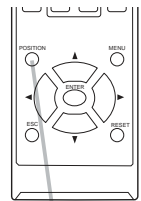

1. Press **POSITION** button on the remote control when no menu is indicated.
- The "POSITION" indication will appear on the screen.
2. Use the **▲/▼/◀/▶** cursor buttons to adjust the picture position.
- When you want to reset the operation, press **RESET** button on the remote control during the operation.
- To complete this operation, press **POSITION** button again. Even if you do not do anything, the dialog will automatically disappear after a few seconds.



POSITION button

- When this function is performed on a video signal, some image such as an extra-line may appear at outside of the picture.
- When this function is performed on a video signal, the range of this adjustment depends on OVER SCAN in IMAGE menu ([41](#)) setting. It is not possible to adjust when OVER SCAN is set to 10.
- If **POSITION** button is pressed when a menu is indicated on screen, the displayed picture does not move its position but the menu does.
- This function is unavailable for a signal from the **LAN**, **USB TYPE A**, **USB TYPE B**, **HDMI1** or **HDMI2/MHL** port.

Correcting the keystone/perfect fit distortions

1. Press **KEYSTONE** button on the remote control. A dialog will appear on the screen to aid you in correcting the distortion.
2. Use the ▲/▼ cursor buttons to select **AUTO**, **MANUAL** or **PERFECT FIT** operation, and press the ► button to perform the following.
 - (1) **AUTO** performs the automatic vertical keystone correction.
 - (2) **MANUAL** displays a dialog for keystone correction. Use the ▲/▼ buttons to select  **KEYSTONE /**  **KEYSTONE**, then use the ◀/▶ buttons for adjustment.
 - (3) **PERFECT FIT** displays a dialog for adjusting the shape of the projected image in each of the corners and sides.

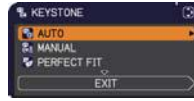

KEYSTONE button

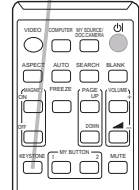

To close the dialog and complete this operation, press **KEYSTONE** button again. Even if you do not do anything, the dialog will automatically disappear after about ten seconds.

- The adjustable range of this function will vary among inputs. For some input, this function may not work well.
- When REAR / CEILING or FRONT / CEILING is selected for the INSTALLATION item in the SETUP menu, the automatic vertical keystone correction function may not work correctly if the projector screen is slanted or tilted downwards.
- When the zoom adjustment is set to the TELE (telephoto focus), this function may be excessive. This function should be used when the zoom adjustment is set to the full WIDE (wide-angle focus) whenever possible.
- When the projector is placed on the level (about $\pm 4^\circ$), the automatic keystone distortion correction may not work.
- When the projector is inclined to near ± 30 degree or over, this function may not work well.
- This function will be unavailable when the TRANSITION DETECTOR is on ( 77).
- The display will be dark for a split second while switching the **KEYSTONE**, but this is not a malfunction.

Using the magnify feature

MAGNIFY ON/OFF button

1. Press the **MAGNIFY ON** button on the remote control. The picture will be magnified, and the MAGNIFY dialog will appear on the screen. When the **MAGNIFY ON** button is pressed for the first time after the projector is turned on, the picture will be zoomed by 1.5 times. On the dialog, triangle marks to show each direction will be displayed.

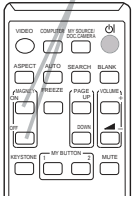

2. The display magnification of the projector switches in order with every press of the **MAGNIFY ON** button.
 - For computer signals or HDMI™ (RGB) signals
1.5 times → 2 times → 3 times → 4 times → 1 time
 - For video signals, component video signals, HDMI™ (Component) or MHL® signals
1.5 times → 2 times → 1 time
3. While the triangles are displayed on the dialog, use the ▲/▼/◀/▶ cursor buttons to shift the magnifying area.
4. Press the **MAGNIFY OFF** button on the remote control to exit magnification.
 - The MAGNIFY dialog will automatically disappear in several seconds with no operation. The dialog will appear again if the **MAGNIFY ON** button is pressed when the dialog has automatically disappeared.
 - The magnification is automatically disabled when the displaying signal or its display condition is changed.
 - While the magnification is active, the keystone distortion condition may vary. It will be restored when the magnification is disabled.
 - Some horizontal stripes might be visible on the image while magnification is active.
 - This function is not available in the following cases:
 - A sync signal in the range not supported is input.
 - There is no input signal.

Temporarily freezing the screen

1. Press the **FREEZE** button on the remote control.
 - The “FREEZE” indication will appear on the screen (however, the indication will not appear when the OFF is selected for the MESSAGE item in the SCREEN menu (📖55)), and the projector will go into the FREEZE mode, which the picture is frozen.

To exit the FREEZE mode and restore the screen to normal, press the **FREEZE** button again.

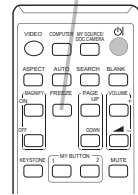
FREEZE button



- The projector automatically exits from the FREEZE mode when some control buttons are pressed.
- If the projector continues projecting a still image for a long time, the LCD panel might possibly be burned in. Do not leave the projector in the FREEZE mode for too long.
- Images might appear degraded when this function is operated, but it is not a malfunction.

Temporarily blanking the screen

1. Press **BLANK** button on the remote control.
 - The BLANK screen will be displayed instead of the screen of input signal. Please refer to BLANK item in SCREEN menu (📖53).

To exit from the BLANK screen and return to the input signal screen, press **BLANK** button again.

BLANK button

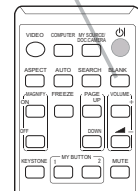

- The projector automatically exits from the BLANK mode when some control buttons are pressed.

⚠ WARNING ▶ If you wish to have a blank screen while the projector's lamp is on, use the BLANK function above. Taking any other action may cause the damage on the projector. Blocking the beam by something causes high temperature and could result in fire or smoke.

NOTE • The sound is not connected with the BLANK screen function. If necessary, set the volume or mute first. To display the BLANK screen and mute the sound at one time, use AV MUTE function (📖62).

Using the menu function

This projector has the following menus:

PICTURE, IMAGE, INPUT, SETUP, AUDIO, SCREEN, OPTION, NETWORK, SECURITY and EASY MENU.

EASY MENU consists of functions often used, and the other menus are classified into each purpose and brought together as the ADVANCED MENU.

Each of these menus is operated using the same methods. While the projector is displaying any menu, the **MENU** button on the projector works as the cursor buttons. The basic operations of these menus are as follows.

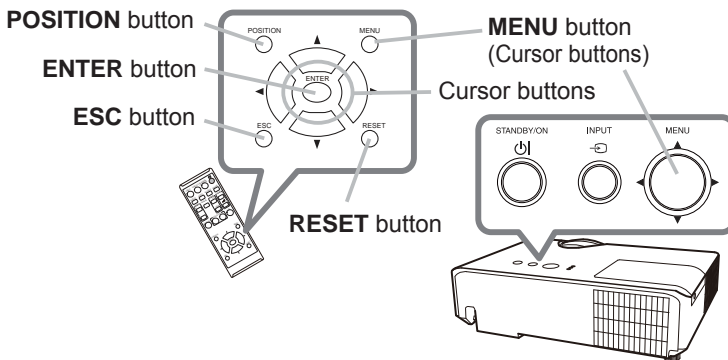

1. To start the MENU, press the **MENU** button. The MENU you last used (EASY or ADVANCED) will appear. EASY MENU has priority to appear just after powered on.

2. In the EASY MENU

- (1) Use the ▲/▼ cursor buttons to select an item to operate. If you want to change it to the ADVANCED MENU, select the ADVANCED MENU.
- (2) Use the ◀/▶ cursor buttons to operate the item.

In the ADVANCED MENU

- (1) Use the ▲/▼ cursor buttons to select a menu. If you want to change it to the EASY MENU, select the EASY MENU. The items in the menu appear on the right side.
- (2) Press the ▶ cursor button or **ENTER** button to move the cursor to the right side. Then use the ▲/▼ cursor buttons to select an item to operate and press the ▶ cursor button or **ENTER** button to progress. The operation menu or dialog of the selected item will appear.
- (3) Use the buttons as instructed in the OSD to operate the item.



(continued on next page)

Using the menu function (continued)

3. To close the MENU, press the **MENU** button again or select EXIT and press the ◀ cursor button or **ENTER** button. Even if you do not do anything, the dialog will automatically disappear after about 30 seconds.
 - If you want to move the menu position, use the cursor buttons after pressing the **POSITION** button.
 - Some functions cannot be performed when a certain input port is selected, or when a certain input signal is displayed.
 - When you want to reset the operation, press **RESET** button on the remote control during the operation. Note that some items (ex. LANGUAGE, VOLUME) cannot be reset.
 - In the ADVANCED MENU, when you want to return to the previous display, press the ◀ cursor button or **ESC** button on the remote control.

Indication in OSD (On Screen Display)

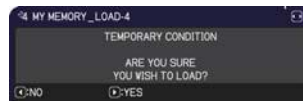

The meanings of the general words on the OSD are as follows.





Indication	Meaning
EXIT	Selecting this word finishes the OSD menu. It's the same as pressing the MENU button.
RETURN	Selecting this word returns the menu to the previous menu.
CANCEL or NO	Selecting this word cancels the operation in the present menu and returns to the previous menu.
OK or YES	Selecting this word executes the prepared function or shifts the menu to the next menu.

EASY MENU

From the EASY MENU, items shown in the table below can be performed.

Select an item using the ▲/▼ cursor buttons. Then perform it according to the following table.



Item	Description
ASPECT	Using the ◀/▶ buttons switches the mode for aspect ratio. See the ASPECT item in IMAGE menu (📖 39).
AUTO KEYSTONE	Using the ▶ button executes the auto keystone function. See the AUTO KEYSTONE item in SETUP menu (📖 47).
 KEYSTONE	Using the ◀/▶ buttons corrects the vertical keystone distortion. See the  KEYSTONE item in SETUP menu (📖 47).
 KEYSTONE	Using the ◀/▶ buttons corrects the horizontal keystone distortion. See the  KEYSTONE item in SETUP Menu (📖 48).
PERFECT FIT	Pressing the ▶ button displays the dialog for adjusting the shape of the projected image in each of the corners and sides. See the PERFECT FIT item in SETUP menu (📖 48)
PICTURE MODE	<p>Using the ◀/▶ buttons switches the picture mode. The picture modes are combinations of GAMMA and COLOR TEMP settings. Choose a suitable mode according to the projected source.</p> <p> </p> <ul style="list-style-type: none"> • When the combination of GAMMA and COLOR TEMP differs from pre-assigned modes above, the display on the menu for the PICTURE MODE is "CUSTOM". Please refer to the GAMMA and COLOR TEMP (📖 37, 38) items in PICTURE menu. • Lines or other noise might appear on the screen when this function is operated, but it is not a malfunction.

(continued on next page)

Item	Description
ECO MODE	Using the ◀/▶ buttons switches the ECO MODE. See the ECO MODE item of the LAMP & FILTER item in SETUP menu (📖 49).
INSTALLATION	Pressing the ▶ button displays the INSTALLATION dialog. See the INSTALLATION item in SETUP menu (📖 51).
RESET	Performing this item resets all of the EASY MENU items except the FILTER TIME and LANGUAGE. A dialog is displayed for confirmation. Selecting the OK using the ▶ button performs resetting.
FILTER TIME	The usage time of the air filter is shown in the menu. Performing this item resets the filter time which counts usage time of the air filter. A dialog is displayed for confirmation. Selecting the OK using the ▶ button performs resetting. See the FILTER TIME item of the LAMP & FILTER item in SETUP menu (📖 50).
LANGUAGE	Using the ◀/▶ buttons changes the display language. See the LANGUAGE item in SCREEN menu (📖 53).
ADVANCED MENU	Press the ▶ or ENTER button to use the menu of PICTURE, IMAGE, INPUT, SETUP, AUDIO, SCREEN, OPTION, NETWORK or SECURITY.
EXIT	Press the ◀ or ENTER button to finish the OSD menu.

PICTURE menu

From the PICTURE menu, items shown in the table below can be performed.

Select an item using the ▲/▼ cursor buttons, and press the ► cursor button or **ENTER** button to execute the item. Then perform it according to the following table.





Item	Description
BRIGHTNESS	Using the ◀/▶ buttons adjusts the brightness. Dark ⇔ Light
CONTRAST	Using the ◀/▶ buttons adjusts the contrast. Weak ⇔ Strong
HDCR	A function to show a clear picture in a bright room. Using the ◀/▶ buttons adjusts the contrast. • This function may not work properly when IMAGE OPTIMIZER is enabled.
ACCENTUALIZER	ACCENTUALIZER is a function to improve the legibility. Using the ◀/▶ buttons adjusts the sharpness. Weak ⇔ Strong • There may be some noise and/or the screen may flicker for a moment when an adjustment is made. This is not a malfunction. • This function may not work properly when IMAGE OPTIMIZER is enabled.

(continued on next page)

Item	Description
<p>GAMMA</p>	<p>Using the ▲/▼ buttons switches the gamma mode.</p> <p>To adjust CUSTOM</p> <p>Selecting a mode whose name includes CUSTOM and then pressing the ► button or the ENTER button displays a dialog to aid you in adjusting the mode. This function is useful when you want to change the brightness of particular tones.</p> <p>Choose an item using the ◀/▶ buttons, and adjust the level using the ▲/▼ buttons.</p> <p>You can display a test pattern for checking the effect of your adjustment by pressing the ENTER button. Each time you press the ENTER button, the pattern changes as below.</p> <p>No pattern ⇨ Gray scale of 9 steps ⇩</p> <p>⇩ Ramp ⇨ Gray scale of 15 steps</p> <p>The eight equalizing bars correspond to eight tone levels of the test pattern (Gray scale of 9 steps) except the darkest in the left end. If you want to adjust the 2nd tone from left end on the test pattern, use the equalizing adjustment bar "1". The darkest tone at the left end of the test pattern cannot be controlled with any of equalizing adjustment bar.</p> <ul style="list-style-type: none"> • Lines or other noise might appear on the screen when this function is operated, but it is not a malfunction.



(continued on next page)

Item	Description
<p>COLOR TEMP</p>	<p>Using the ▲/▼ buttons switches the color temperature mode.</p> <p>To adjust CUSTOM</p> <p>Selecting a mode whose name includes CUSTOM and then pressing the ► button or the ENTER button displays a dialog to aid you in adjusting the OFFSET and GAIN of the selected mode.</p>  <p>OFFSET adjustments change the color intensity on the whole tones of the test pattern.</p> <p>GAIN adjustments mainly affect color intensity on the brighter tones of the test pattern.</p> <p>Choose an item using the ◀/▶ buttons, and adjust the level using the ▲/▼ buttons.</p> <p>You can display a test pattern for checking the effect of your adjustment by pressing the ENTER button. Each time you press the ENTER button, the pattern changes as below.</p> <p>No pattern ⇔ Gray scale of 9 steps ⇐↵ ↵⇐⇐ Ramp ⇔ Gray scale of 15 steps</p> <ul style="list-style-type: none"> • Lines or other noise might appear on the screen when this function is operated, but it is not a malfunction. 
<p>COLOR</p>	<p>Using the ◀/▶ buttons adjusts the strength of whole color.</p> <p>Weak ⇔ Strong</p> <ul style="list-style-type: none"> • This item can be selected only for a video and component video signal. • For an HDMI™ signal, this item can also be selected if either (1) or (2) applies. <ul style="list-style-type: none"> (1) DIGITAL FORMAT item in the INPUT menu is set to VIDEO. (2) DIGITAL FORMAT item in the INPUT menu is set to AUTO, and the projector recognizes that it receives video signals.
<p>TINT</p>	<p>Using the ◀/▶ buttons adjusts the tint.</p> <p>Reddish ⇔ Greenish</p> <ul style="list-style-type: none"> • This item can be selected only for a video and component video signal. • For an HDMI™ signal, this item can also be selected if either (1) or (2) applies. <ul style="list-style-type: none"> (1) DIGITAL FORMAT item in the INPUT menu is set to VIDEO. (2) DIGITAL FORMAT item in the INPUT menu is set to AUTO, and the projector recognizes that it receives video signals.

(continued on next page)

Item	Description
SHARPNESS	<p>Using the ◀/▶ buttons adjusts the sharpness. Weak ⇔ Strong</p> <ul style="list-style-type: none"> • There may be some noise and/or the screen may flicker for a moment when an adjustment is made. This is not a malfunction.
ACTIVE IRIS	<p>Using the ▲/▼ cursor buttons changes the active iris control mode. PRESENTATION ⇔ THEATER ⇔ OFF</p>  <p><u>PRESENTATION</u> : The active iris displays the best presentation image for both bright and dark scenes. <u>THEATER</u> : The active iris displays the best theater image for both bright and dark scenes. <u>OFF</u> : The active iris is always open.</p> <ul style="list-style-type: none"> • The screen may flicker when the PRESENTATION or THEATER modes are selected. If this occurs select OFF.
MY MEMORY	<p>This projector has 4 memories for adjustment data (for all the items of the PICTURE menu). Selecting a function using the ▲/▼ buttons and pressing the ▶ or ENTER button performs each function.</p>  <p><u>SAVE-1, SAVE-2, SAVE-3, SAVE-4</u> Performing a SAVE function saves the current adjustment data into the memory linked in the number included in the function's name.</p> <ul style="list-style-type: none"> • Remember that the current data being stored of a memory will be lost by saving new data into the memory. <p><u>LOAD-1, LOAD-2, LOAD-3, LOAD-4</u> Performing a LOAD function loads the data from the memory linked in the number included in the function's name, and adjusts the picture automatically depending on the data.</p> <ul style="list-style-type: none"> • The LOAD functions whose linked memory has no data are skipped. • Remember that the current adjusted condition will be lost by loading data. If you want to keep the current adjustment, please save it before performing a LOAD function. • There may be some noise and the screen may flicker for a moment when loading data. This is not malfunction. • You can perform the LOAD function using MY BUTTON. Please see MY BUTTON item in OPTION menu (▶ 61, 62).

IMAGE menu

From the IMAGE menu, items shown in the table below can be performed. Select an item using the ▲/▼ cursor buttons, and press the ► cursor button or **ENTER** button to execute the item. Then perform it according to the following table.

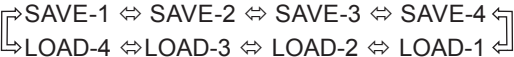

Item	Description
ASPECT	Using the ▲/▼ buttons switches the mode for aspect ratio.
	For a computer signal
	CP-X2542WN/CP-X3042WN/CP-X4042WN:
	NORMAL ⇄ 4:3 ⇄ 16:9 ⇄ 16:10 ⇄ ZOOM ↑↑↑↑↑↑↑↑↑↑
	CP-WX3042WN/CP-WX4042WN:
	NORMAL ⇄ 4:3 ⇄ 16:9 ⇄ 16:10 ⇄ ZOOM ⇄ NATIVE ↑↑↑↑↑↑↑↑↑↑
	For an HDMI™ or MHL® signal
	CP-X2542WN/CP-X3042WN/CP-X4042WN:
	NORMAL ⇄ 4:3 ⇄ 16:9 ⇄ 16:10 ⇄ 14:9 ⇄ ZOOM ↑↑↑↑↑↑↑↑↑↑
	CP-WX3042WN/CP-WX4042WN:
NORMAL ⇄ 4:3 ⇄ 16:9 ⇄ 16:10 ⇄ 14:9 ⇄ ZOOM ⇄ NATIVE ↑↑↑↑↑↑↑↑↑↑	
For a video signal or component video signal	
CP-X2542WN/CP-X3042WN/CP-X4042WN:	
4:3 ⇄ 16:9 ⇄ 14:9 ⇄ ZOOM ↑↑↑↑↑↑↑↑↑↑	
CP-WX3042WN/CP-WX4042WN:	
4:3 ⇄ 16:9 ⇄ 16:10 ⇄ 14:9 ⇄ ZOOM ⇄ NATIVE ↑↑↑↑↑↑↑↑↑↑	
For an input signal from the LAN, USB TYPE A or USB TYPE B port, or if there is no signal	
CP-X2542WN/CP-X3042WN/CP-X4042WN: 4:3 (fixed)	
CP-WX3042WN/CP-WX4042WN: 16:10 (fixed)	
• The NORMAL mode keeps the original aspect ratio of the signal.	

(continued on next page)

Item	Description
OVER SCAN	<p>Using the ◀/▶ buttons adjusts the over-scan ratio. Small (It magnifies picture) ⇔ Large (It reduces picture)</p> <ul style="list-style-type: none"> • This item can be selected only for a video and component video signal. • For an HDMI™ signal, this item can also be selected if either (1) or (2) applies. <ol style="list-style-type: none"> (1) DIGITAL FORMAT item in the INPUT menu is set to VIDEO. (2) DIGITAL FORMAT item in the INPUT menu is set to AUTO, and the projector recognizes that it receives video signals.
V POSITION	<p>Using the ◀/▶ buttons adjusts the vertical position. Down ⇔ Up</p> <ul style="list-style-type: none"> • Over-adjusting the vertical position may cause noise to appear on the screen. If this occurs, please reset the vertical position to the default setting. Pressing the RESET button when the V POSITION is selected will reset the V POSITION to the default setting. • When this function is performed on a video signal, the range of this adjustment depends on OVER SCAN (📐41) setting. It is not possible to adjust when OVER SCAN is set to 10. • This function is unavailable for a signal from the LAN, USB TYPE A, USB TYPE B, HDMI1 or HDMI2/MHL port.
H POSITION	<p>Using the ◀/▶ buttons adjusts the horizontal position. Right ⇔ Left</p> <ul style="list-style-type: none"> • Over-adjusting the horizontal position may cause noise to appear on the screen. If this occurs, please reset the horizontal position to the default setting. Pressing the RESET button when the H POSITION is selected will reset the H POSITION to the default setting. • When this function is performed on a video signal, the range of this adjustment depends on OVER SCAN (📐41) setting. It is not possible to adjust when OVER SCAN is set to 10. • This function is unavailable for a signal from the LAN, USB TYPE A, USB TYPE B, HDMI1 or HDMI2/MHL port.

(continued on next page)

Item	Description
H PHASE	<p>Using the ◀/▶ buttons adjusts the horizontal phase to eliminate flicker. Right ⇔ Left</p> <ul style="list-style-type: none"> • This item can be selected only for a computer signal or a component video signal. This function is unavailable for a signal from the LAN, USB TYPE A, USB TYPE B, HDMI1 or HDMI2/MHL port.
H SIZE	<p>Using the ◀/▶ buttons adjusts the horizontal size. Small ⇔ Large</p> <ul style="list-style-type: none"> • This item can be selected only for a computer signal. This function is unavailable for a signal from the LAN, USB TYPE A, USB TYPE B, HDMI1 or HDMI2/MHL port. • When this adjustment is excessive, the picture may not be displayed correctly. In such a case, please reset the adjustment by pressing the RESET button on the remote control during this operation. • Images might appear degraded when this function is operated, but it is not a malfunction.
AUTO ADJUST EXECUTE	<p>Selecting this item performs the automatic adjustment feature.</p> <p>For a computer signal The vertical position, the horizontal position and the horizontal phase will be automatically adjusted. Make sure that the application window is set to its maximum size prior to attempting to use this feature. A dark picture may still be incorrectly adjusted. Use a bright picture when adjusting.</p> <p>For a video signal The video format best suited for the respective input signal will be selected automatically. This function is available only when the AUTO is selected for the VIDEO FORMAT item in the INPUT menu (📖 44). The vertical position and horizontal position will be automatically set to the default.</p> <p>For a component video signal The vertical position and horizontal position will be automatically set to the default. The horizontal phase will be automatically adjusted.</p> <ul style="list-style-type: none"> • The automatic adjustment operation requires approx. 10 seconds. Also please note that it may not function correctly with some input. • When this function is performed for a video signal, a certain extra such as a line may appear outside a picture. • When this function is performed for a computer signal, a black frame may be displayed on the edge of the screen, depending on the computer model. • The items adjusted by this function may vary when the FINE or DISABLE is selected for the AUTO ADJUST item of the SERVICE item in the OPTION menu (📖 66).

INPUT menu



From the INPUT menu, items shown in the table below can be performed.

Select an item using the ▲/▼ cursor buttons, and press the ► cursor button or **ENTER** button to execute the item. Then perform it according to the following table.



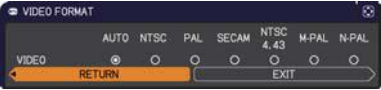

Item	Description
PROGRESSIVE	<p>Using the ▲/▼ buttons switches the progress mode. TV ⇄ FILM ⇄ OFF ↑—————↑</p> <ul style="list-style-type: none"> • This function works only for a video signal, component video signal (of 480i@60 or 576i@50 or 1080i@50/60) and an HDMI™ signal (of 480i@60 or 576i@50 or 1080i@50/60) and MHL® signal (of 480i@60 or 576i@50 or 1080i@50/60). • When TV or FILM is selected, the screen image will be sharp. FILM adapts to the 2-3 Pull-Down conversion system. But these may cause a certain defect (for example, jagged line) of the picture for a quick moving object. In such a case, please select OFF, even though the screen image may lose sharpness.
VIDEO NR	<p>Using the ▲/▼ buttons switches the noise reduction mode. HIGH ⇄ MID ⇄ LOW ↑—————↑</p> <ul style="list-style-type: none"> • This function works only for a video signal, component video signal (of 480i@60 or 576i@50 or 1080i@50/60) and an HDMI™ signal (of 480i@60 or 576i@50 or 1080i@50/60) and MHL® signal (of 480i@60 or 576i@50 or 1080i@50/60).
COLOR SPACE	<p>Using the ▲/▼ buttons switches the mode for color space. AUTO ⇄ RGB ⇄ SMPTE240 ⇄ REC709 ⇄ REC601 ↑—————↑</p> <ul style="list-style-type: none"> • This item can be selected only for a computer signal, component video signal(except for signals from the LAN, USB TYPE A and USB TYPE B ports) , an HDMI™ signal or MHL® signal. • The AUTO mode automatically selects the optimum mode. • The AUTO operation may not work well at some signals. In such a case, it might be good to select a suitable mode except AUTO.

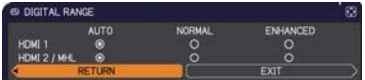



(continued on next page)

Item	Description
<p>VIDEO FORMAT</p>	<p>The video format for VIDEO port can be set.</p> <p>Using the ◀/▶ buttons switches the mode for video format.</p>  <p>AUTO ⇄ NTSC ⇄ PAL ⇄ SECAM ⤴ N-PAL ⇄ M-PAL ⇄ NTSC4.43 ⤴</p> <ul style="list-style-type: none"> • This item is performed only for a video signal from the VIDEO port. • The AUTO mode automatically selects the optimum mode. • The AUTO operation may not work well for some signals. If the picture becomes unstable (e.g. an irregular picture, lack of color), please select the mode according to the input signal.
<p>DIGITAL FORMAT</p>	<p>The video format of HDMI™ input signals from the HDMI1 and HDMI2/MHL ports can be set.</p> <p>(1) Use the ▲/▼ buttons to select the port to be set.</p> <p>(2) Use the ◀/▶ buttons to select the video format.</p> <p>AUTO ⇄ VIDEO ⇄ COMPUTER</p>  <p>↑—————↑</p> <p><u>AUTO</u>: automatically sets the optimum mode. <u>VIDEO</u>: sets the suitable mode for DVD signals. <u>COMPUTER</u>: sets the suitable mode for computer signals.</p> <ul style="list-style-type: none"> • When the COMPUTER is selected, the functions COLOR (PICTURE menu), TINT (PICTURE menu) and OVER SCAN (IMAGE menu) are unavailable.
<p>DIGITAL RANGE</p>	<p>The digital range of HDMI™ input signals from the HDMI1 and HDMI2/MHL ports can be set.</p> <p>(1) Use the ▲/▼ buttons to select the port to be set.</p> <p>(2) Use the ◀/▶ buttons to select the digital range.</p> <p>AUTO ⇄ NORMAL ⇄ ENHANCED</p>  <p>↑—————↑</p> <p>AUTO: automatically sets the optimum mode. NORMAL: sets the suitable mode for DVD signals. (16-235) ENHANCED: sets the suitable mode for computer signals. (0-255)</p> <ul style="list-style-type: none"> • If the contrast of the screen image is too strong or too weak, try finding a more suitable mode.

(continued on next page)

Item	Description
<p>COMPUTER IN</p>	<p>The computer input signal type for COMPUTER IN1 and IN2 ports can be set.</p> <p>(1) Use the ▲/▼ buttons to select the COMPUTER IN port to be set.</p> <p>(2) Use the ◀/▶ buttons to select the computer input signal type. (COMPUTER IN1) AUTO ⇔ SYNC ON G OFF (COMPUTER IN2) AUTO ⇔ SYNC ON G OFF ⇔ MONITOR OUT</p> <ul style="list-style-type: none"> • Selecting the AUTO mode allows you to input a sync on G signal or component video signal from the port (12). • In the AUTO mode, the picture may be distorted with certain input signals. In such a case, remove the signal connector so that no signal is received and select the SYNC ON G OFF, and then reconnect the signal. 
<p>FRAME LOCK</p>	<p>Set the frame lock function on/off for each port.</p> <p>(1) Use the ▲/▼ buttons to select the input ports.</p> <p>(2) Use the ◀/▶ buttons to turn the frame lock function on/off . ON ⇔ OFF</p> <ul style="list-style-type: none"> • This item can be performed only on a signal with a vertical frequency of 49 to 51Hz, 59 to 61 Hz. • When ON is selected, moving pictures are displayed more smoothly. • This function is unavailable for a signal from the HDMI1 and HDMI2/MHL (of 480i@60 or 576i@50 or 1080@50/60) port. 

(continued on next page)

Item	Description
<p>RESOLUTION</p>	<p>The resolution for the COMPUTER IN1 and COMPUTER IN2 input signals can be set on this projector.</p> <p>(1) In the INPUT menu select the RESOLUTION using the ▲/▼ buttons and press the ► button. The RESOLUTION menu will be displayed.</p>  <p>(2) In the RESOLUTION menu select the resolution you wish to display using the ▲/▼ buttons. Selecting AUTO will set a resolution appropriate to the input signal.</p> <p>(3) Pressing the ► or ENTER button when selecting a STANDARD resolution will automatically adjust the horizontal and vertical positions, clock phase and horizontal size. The INPUT_INFORMATION dialog will be displayed.</p> <p style="text-align: center;">STANDARD</p>  <p>(4) To set a custom resolution use the ▲/▼ buttons to select the CUSTOM and the RESOLUTION_CUSTOM box will be displayed. Set the horizontal (HORZ) and vertical (VERT) resolutions using the ▲/▼/◀/▶ buttons. This function may not support all resolutions.</p> <p style="text-align: center;">CUSTOM</p>  <p>(5) Move the cursor to OK on screen and press the ► or ENTER button. The message "ARE YOU SURE YOU WISH TO CHANGE RESOLUTION?" appears. To save the setting, press the ► button. The horizontal and vertical positions, clock phase and horizontal size will be automatically adjusted. The INPUT_INFORMATION dialog will be displayed.</p>  <p>(6) To revert back to the previous resolution without saving changes, move the cursor to CANCEL on screen and press the ◀ or ENTER button. The screen will then return to the RESOLUTION menu displaying the previous resolution.</p> <ul style="list-style-type: none"> • For some pictures, this function may not work well.
<p>MHL STANDBY PWR.</p>	<p>Using the ▲/▼ buttons switches the MHL STANDBY PWR. ON/OFF. ON ⇔ OFF</p> <ul style="list-style-type: none"> • When the STANDBY MODE is set to SAVING, the MHL STANDBY PWR. menu can not be operated and MHL power feeding is unavailable with standby mode. • When the MHL STANDBY PWR. is set to ON, there may be some noise with standby mode. This is not malfunction.

SETUP menu

From the SETUP menu, items shown in the table below can be performed.

Select an item using the ▲/▼ cursor buttons, and press the ► cursor button or **ENTER** button to execute the item. Then perform it according to the following table.



Item	Description
<p>AUTO KEYSTONE</p>	<p>Selecting this item performs the Automatic keystone distortion correction. Projector automatically corrects vertical keystone distortion due to the (forward/backward) setup angle by itself. This function will be executed only once when selected in the menu. When the slant of the projector is changed, execute this function again.</p> <ul style="list-style-type: none"> • The adjustable range of this function will vary among inputs. For some input, this function may not work well. • When REAR / CEILING or FRONT / CEILING is selected for the INSTALLATION item in the SETUP menu, this function may not work correctly if the projector screen is slanted or tilted downwards. • When the zoom adjustment is set to the TELE (telephoto focus), this function may be excessive. This function should be used when the zoom adjustment is set to the full WIDE (wide-angle focus) whenever possible. • When the projector is placed on the level (about $\pm 4^\circ$), this function may not work. • When the projector is inclined to near ± 30 degree or over, this function may not work well. • This function will be unavailable when the TRANSITION DETECTOR (📖77) is ON or the screen is adjusted by PERFECT FIT (📖48).
<p>KEYSTONE</p>	<p>Using the ◀/▶ buttons corrects the vertical keystone distortion.</p> <p>Shrink the bottom of the image ↔ Shrink the top of the image</p> <ul style="list-style-type: none"> • The adjustable range of this function will vary among inputs. For some input, this function may not work well. • When the zoom adjustment is set to the TELE (telephoto focus), this function may be excessive. This function should be used when the zoom adjustment is set to the full WIDE (wide-angle focus) whenever possible. • This function will be unavailable when the TRANSITION DETECTOR (📖77) is ON or the screen is adjusted by PERFECT FIT (📖48).

(continued on next page)

Item	Description
 KEYSTONE	<p>Using the ◀/▶ buttons corrects the horizontal keystone distortion.</p> <p>Shrink the right of the image ↔ Shrink the left of the image</p> <ul style="list-style-type: none"> • The adjustable range of this function will vary among inputs. For some input, this function may not work well. • This function is unavailable when the TRANSITION DETECTOR (📖77) is ON or the screen is adjusted by PERFECT FIT (📖48).
PERFECT FIT	<p>This item allows you to adjust the shape of the projected image in each of the corners and sides.</p> <p>(1) Choose a corner or side to adjust using the ▲/▼/◀/▶ buttons and press the ENTER or INPUT button.</p> <p>(2) Adjust the distortion as below. Use the ▲/▼/◀/▶ buttons to adjust the position of the corner. Use the ▲/▼ buttons to adjust the distortion of the top or bottom side, after defining the adjusting position with the ◀/▶ buttons.</p> <p>Use the ◀/▶ buttons to adjust the distortion of the left or right side, after defining the adjusting position with the ▲/▼ buttons.</p> <p>(3) To adjust another corner or side, follow the same procedure from (1) above. To reset the adjustment of all the corners and sides, select RESET with the ▲/▼/◀/▶ buttons and press the ENTER or INPUT button.</p> <p>(4) This projector is equipped with a memory feature for PERFECT FIT adjustment. Up to 3 sets of adjustments can be stored.</p> <ul style="list-style-type: none"> • SAVE: To store the current PERFECT FIT adjustment, select one of the SAVE icons 📁 numbered 1 to 3 (number of the memory) with the ◀/▲/▼ buttons and press the ENTER or INPUT button. Remember that the current data being stored of a memory will be lost by saving new data into the memory. • LOAD: To recall stored adjustments, select one of the LOAD icons 📁 numbered 1 to 3 (number of the memory) with the ◀/▲/▼ buttons and press the ENTER or INPUT button. Remember that the current adjusted condition will be lost by loading data. If you want to keep the current adjustment, please save it before performing a LOAD function. - The LOAD functions whose linked memory has no data are skipped. - There may be some noise and the screen may flicker for a moment when loading data. This is not malfunction.

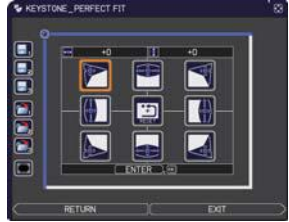

(continued on next page)

Item	Description
<p>PERFECT FIT (continued)</p>	<ul style="list-style-type: none"> • While the distortion is adjusted with the PERFECT FIT function, keystone adjustment feature is unavailable. To correct the keystone distortion, reset the adjustment of all the corners and sides. • The adjustable range of this correction will vary among inputs. For some input, this function may not work well. • One adjustment position common to the top and bottom sides can be set. Also, another adjustment position common to the left and right sides can be set. • The distortion of the top and bottom sides can be adjusted only in the same direction, pincushion or barrel. The adjustment for the left and right sides is carried out in the same manner.
<p>LAMP & FILTER</p>	<p>AUTO ECO MODE</p> <p>Using the ▲/▼ buttons turns on/off the AUTO ECO MODE. ON ⇔ OFF</p> <ul style="list-style-type: none"> • When ON is selected, the projector will always be set to ECO-2 at start-up regardless of the ECO MODE (📄<i>below</i>) setting. An OSD message “AUTO ECO MODE” will be displayed for a while when the projector starts with this function activated.
	<p>ECO MODE</p> <p>Using the ▲/▼ buttons switches the ECO MODE. OFF ⇔ ECO-1 ⇔ ECO-2 ⇔ INTELLIGENT ECO ⇔ SAVER</p>  <ul style="list-style-type: none"> • When the ECO-1/2 is selected, acoustic noise and screen brightness are reduced. • When INTELLIGENT ECO is selected, the brightness of the lamp changes according to the level of the input signal. The lamp becomes brighter when the input signal level is high and darker when the level is low. If dark images are projected continuously, the brightness of the lamp may increase to maintain its performance. • When SAVER is selected, you can select the time within 1 to 30 min. for SAVER MODE using the ► button. If the image signal level doesn't change more than the period set, the lamp brightness is reduced and electric power consumption decreased. If the image signal level changes or any buttons are operated, the lamp will brighten again. If dark images are projected continuously, the brightness of the lamp may increase to maintain its performance. • When AUTO ECO MODE (📄<i>above</i>) is set to ON, the projector will always be set to ECO-2 at start-up regardless this setting.

(continued on next page)

Item	Description
LAMP & FILTER (continued)	<p>The lamp time is the usage time of the lamp, counted after the last resetting. Pressing the RESET button on the remote control or the ► button of the projector displays a dialog. To reset the lamp time, select the OK using the ► button. CANCEL ⇨ OK</p> <ul style="list-style-type: none"> • Please reset the lamp time only when you have replaced the lamp, for a suitable indication about the lamp. • For the lamp replacement, see the section Replacing the lamp (108). • The IMAGE OPTIMIZER function does not work properly unless LAMP TIME is initialized when replacing a lamp.
	<p>The filter time is the usage time of the air filter, counted after the last resetting. Pressing the RESET button on the remote control or the ► button of the projector displays a dialog. To reset the filter time, select the OK using the ► button. CANCEL ⇨ OK</p> <ul style="list-style-type: none"> • Please reset the filter time only when you have cleaned or replaced the air filter, for a suitable indication about the air filter. • For the air filter cleaning, see the section Cleaning and replacing the air filter (100).
	<p>Use the ▲/▼ button to set the timer for notifying by the message when to replace the filter unit 100h ⇨ ⇨ 5000h ⇨ OFF</p> <p>After choosing an item except OFF, the message “REMINDER *** HRS PASSED” will appear after the timer reaches the interval time set by this feature (104).</p> <p>When the OFF is chosen, the message will not appear. Utilize this feature to keep the air filter clean, setting the suitable time according to your environment of this projector.</p> <ul style="list-style-type: none"> • Please take care of the filter unit periodically, even if there is no message. If the air filter becomes to be blocked by dust or other matter, the internal temperature will rise, which could cause malfunction, or reduce the lifetime of the projector. • Please be careful with the operating environment of the projector and the condition of the filter unit.
IMAGE OPTIMIZER	<p>When this function is enabled, automatic image correction is performed to maintain visibility in accordance with lamp deterioration.</p> <ul style="list-style-type: none"> • This function may not work properly when HDCR/ACCENTUALIZER is set to other than 0. • This function does not work properly unless LAMP TIME is initialized when replacing a lamp.

(continued on next page)

Item	Description
<p>INSTALLATION</p>	<p>Pressing the ► button displays the dialog for changing the INSTALLATION setting.</p>  <p>Use the ▲/▼ buttons to select the desired setting on the INSTALLATION dialog.</p> <p>If TRANSITION DETECTOR is ON and the INSTALLATION status is changed, the TRANSITION DETECTOR ON alarm (🔊77) will be displayed when the projector is restarted.</p>
<p>STANDBY MODE</p>	<p>Using ▲/▼ buttons switches the standby mode setting between NORMAL and SAVING.</p> <p>NORMAL ⇔ SAVING</p> <p>When SAVING is selected, the power consumption in the standby mode is lowered with some functional restriction as below:</p> <ul style="list-style-type: none"> • When SAVING is selected, the RS-232C communication control except to turn the projector on and the network function are disabled while the projector is in the standby mode. If the COMMUNICATION TYPE in the COMMUNICATION menu is set to NETWORK BRIDGE, all of the RS-232C commands are disabled (🔊68). • When SAVING is selected, STANDBY setting of AUDIO SOURCE (🔊52) is invalid, no signal is output from AUDIO OUT port and no sound from a built-in speaker. • When SAVING is selected, STANDBY setting of MONITOR OUT is invalid, and no signal is output from MONITOR OUT port in the standby mode. • The USB connection is disabled while the projector is in standby mode if the STANDBY MODE item in the SETUP menu of the projector is set to SAVING. • When SAVING is selected, CLONING load function is invalid while in STANDBY MODE. • This function will be unavailable when NETWORK BRIDGE is selected for COMMUNICATION TYPE. (🔊OPTION menu > SERVICE > COMMUNICATION)



AUDIO menu

From the AUDIO menu, items shown in the table below can be performed. Select an item using the ▲/▼ cursor buttons, and press the ► cursor button or the **ENTER** button to execute the item. Then perform it according to the following table.



Item	Description								
VOLUME	Using the ◀/▶ buttons adjusts the volume. Low ⇔ High								
SPEAKER	Using the ▲/▼ buttons turns on/off the built-in speaker. ON ⇔ OFF When OFF is selected, the built-in speaker does not work.								
AUDIO SOURCE	<p>While the image signal from the input port chosen in step (1) is projected, the audio signal from the input port selected in step (2) is output to both the AUDIO OUT port and built-in speaker of this projector. However, the built-in speaker does not work when SPEAKER is set to OFF.</p> <p>(1) Choose a picture input port using the ▲/▼ buttons. Choose STANDBY to select the sound output in the standby mode.</p> <p>(2) Select an audio input port or the mute icon using the ◀/▶ buttons. The icons indicate the following;</p> <table style="width: 100%; border: none;"> <tr> <td style="width: 50%;">No.1: AUDIO IN1 port</td> <td style="width: 50%;">No.2: AUDIO IN2 port</td> </tr> <tr> <td>No.3: AUDIO IN3 port</td> <td>No.4: LAN port</td> </tr> <tr> <td>No.5: USB TYPE A port</td> <td>No.6: USB TYPE B port</td> </tr> <tr> <td>No.7: HDMI1 port</td> <td>No.8: HDMI2/MHL port</td> </tr> </table> <p>⊗: mutes the sound</p> <ul style="list-style-type: none"> • Audio input from port nos 4 to 8 can only be selected by each of the picture input ports. • Even if the projector is in the standby mode, cooling fans may work and make noises when the built-in speaker is in operation. • C.C. (Closed Caption) is automatically activated when ⊗ is selected and an input signal containing C.C. is received. This function is available only when the signal is NTSC for VIDEO, or 480i@60 for COMPUTER IN1 or COMPUTER IN2, and when AUTO is selected for DISPLAY in the C.C. menu under the SCREEN menu (58). 	No.1: AUDIO IN1 port	No.2: AUDIO IN2 port	No.3: AUDIO IN3 port	No.4: LAN port	No.5: USB TYPE A port	No.6: USB TYPE B port	No.7: HDMI1 port	No.8: HDMI2/MHL port
No.1: AUDIO IN1 port	No.2: AUDIO IN2 port								
No.3: AUDIO IN3 port	No.4: LAN port								
No.5: USB TYPE A port	No.6: USB TYPE B port								
No.7: HDMI1 port	No.8: HDMI2/MHL port								
MIC LEVEL	Using the ▲/▼ buttons switches the input level to match that of the microphone connected to the MIC port. HIGH ⇔ LOW HIGH: for a microphone with an amplifier. LOW: for a microphone without an amplifier.								
MIC VOLUME	Using the ◀/▶ buttons adjusts the volume of the microphone connected to the MIC port. Low ⇔ High								

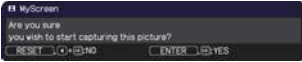

Item	Description
START UP	<p>Using the ▲/▼ buttons switches the mode for the start-up screen. The start-up screen is a screen displayed when no signal or an unsuitable signal is detected.</p> <p>MyScreen ⇄ ORIGINAL ⇄ OFF </p> <p><u>MyScreen</u> : Screen can be registered by the MyScreen item (☒ below).</p> <p><u>ORIGINAL</u> : Screen preset as the standard screen.</p> <p><u>OFF</u> : Plain black screen.</p> <ul style="list-style-type: none"> • To avoid remaining as an afterimage, the START UP screen will change to the AUTO BLANK screen after several minutes. • When the ON is selected to the MyScreen PASSWORD item in the SECURITY menu (☒ 75), the START UP is fixed to MyScreen.
MyScreen	<p>This item allows you to capture an image for use as a MyScreen image which can be used as the BLANK screen and START UP screen. Display the image you want to capture before executing the following procedure.</p> <p>Selecting this item displays a dialog titled “MyScreen”. It will ask you if you start capturing an image from the current screen. Please wait for the target image to be displayed, and press the ENTER or INPUT button to start registration.</p>  <p>To restore the screen and return to the previous dialog, press the RESET button on the remote control.</p> <p>Registration may take several minutes. When the registration is completed, the registered screen and the following message is displayed for several seconds:</p> <p>“MyScreen registration is finished.”</p> <p>If the registration failed, the following message is displayed:</p> <p>“A capturing error has occurred. Please try again.”</p>  <ul style="list-style-type: none"> • This function cannot be selected when the ON is selected to the MyScreen Lock item (☒ 55). • This function cannot be selected when the ON is selected to the MyScreen PASSWORD item in SECURITY menu (☒ 75). • This function is unavailable for a signal from the LAN, USB TYPE A, USB TYPE B, HDMI1 or HDMI2/MHL port.

(continued on next page)

Item	Description
MyScreen Lock	<p>Using the ▲/▼ buttons turns on/off the MyScreen lock function. ON ⇔ OFF</p> <p>When the ON is selected, the item MyScreen is locked. Use this function for protecting the current MyScreen.</p> <ul style="list-style-type: none"> • This function cannot be selected when the ON is selected to the MyScreen PASSWORD item in SECURITY menu (📖 75).
MESSAGE	<p>Using the ▲/▼ buttons turns on/off the message function. ON ⇔ OFF</p> <p>When the ON is selected, the following message function works.</p> <p>“AUTO IN PROGRESS” while automatically adjusting “NO INPUT IS DETECTED” “SYNC IS OUT OF RANGE” “INVALID SCAN FREQ.” “NOT AVAILABLE.” “Searching....” while searching for the input “Detecting....” while an input signal is detected “AUTO ECO MODE” while starting up with AUTO ECO MODE</p> <p>The indication of the input signal displayed by changing The indication of the aspect ratio displayed by changing The indication of the PICTURE MODE displayed by changing The indication of the MY MEMORY displayed by changing The indication of “FREEZE” and “II” while freezing the screen by pressing the FREEZE button. The indication of the TEMPLATE displayed by changing. The indication of the ECO MODE displayed by changing.</p> <ul style="list-style-type: none"> • When the OFF is selected, please remember if the picture is frozen. Do not mistake freezing for a malfunction (📖 31).

(continued on next page)

Item	Description
SOURCE NAME	<p>Each input port for this projector can have a name applied to it.</p> <p>(1) Use the ▲/▼ buttons on the SCREEN menu to select SOURCE NAME and press the ► or ENTER button. The SOURCE NAME menu will be displayed.</p> <p>(2) Use the ▲/▼ buttons on the SOURCE NAME menu to select the port to be named and press the ► button. The SOURCE NAME dialog will be displayed. Right side of the menu is blank until a name is specified.</p> <p>(3) Select an icon you would like to assign to the port in the SOURCE NAME dialog. The name assigned to the port will also be automatically switched according to your icon selection. Press the ENTER or INPUT button to determine your icon selection.</p> <p>(4) Select a number you would like to assign to the port along with the icon. You can select the number either from blank (no number assigned), 1, 2, 3, or 4. Then press the ENTER or INPUT button.</p> <p>(5) If you would like to modify the name assigned to the port, select CUSTOM NAME and press the ENTER or INPUT button.</p> <p>(continued on next page)</p>



(continued on next page)

Item	Description
<p>SOURCE NAME (continued)</p>	<p>(6) The current name will be displayed on the first line. Use the ▲/▼/◀/▶ buttons and the ENTER or INPUT button to select and enter characters. To erase 1 character at one time, press the RESET button or press the ◀ and INPUT button at the same time. Also if you move the cursor to DELETE or ALL CLEAR on screen and press the ENTER or INPUT button, 1 character or all characters will be erased. The name can be a maximum of 16 characters.</p> <p>(7) To change an already inserted character, press the ▲ button to move the cursor to the first line, and use the ◀/▶ buttons to move the cursor on the character to be changed. After pressing the ENTER or INPUT button, the character is selected. Then, follow the same procedure as described at the item (6) above.</p> <p>(8) To finish entering text, move the cursor to the OK on screen and press the ▶, ENTER or INPUT button. To revert to the previous name without saving changes, move the cursor to the CANCEL on screen and press the ◀, ENTER or INPUT button.</p> 
<p>TEMPLATE</p>	<p>Using the ▲/▼ cursor buttons switches the mode for the template screen. Press the ▶ cursor (or the ENTER) button to display the selected template, and press the ◀ cursor button to close the displayed screen. The last selected template is displayed when the MY BUTTON allocated to the TEMPLATE function is pressed (62).</p> <p style="text-align: center;">TEST PATTERN ⇔ DOT-LINE1 ⇔ DOT-LINE2 ⇔ DOT-LINE3 ⇕ MAP2 ⇔ MAP1 ⇔ CIRCLE2 ⇔ CIRCLE1 ⇔ DOT-LINE4</p> <p>You can turn a map upside down and scroll it horizontally when MAP1 or MAP2 is selected. To invert or scroll the map, display the guidance by pressing the RESET button on the remote three seconds or more when MAP1 or MAP2 appears.</p>

(continued on next page)

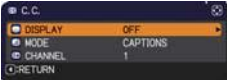
Item	Description
C.C. (Closed Caption)	<p>The C.C. is the function that displays a transcript or dialog of the audio portion of a video, files or other presentation or other relevant sounds. It is required to have NTSC format video or 480i@60 format component video source supporting C.C. feature to utilize this function.</p> <p>It may not work properly, depending on equipment or signal source. In this case, please turn off the Closed Caption.</p> 
	<p>DISPLAY</p> <p>Select Closed Caption DISPLAY setting from following options using ▲/▼ buttons.</p> <p>AUTO ⇔ ON ⇔ OFF</p> <p style="text-align: center;">↑—————↑</p> <p><u>AUTO</u> : Closed Caption automatically displays when the volume is muted.</p> <p><u>ON</u> : Closed Caption is on.</p> <p><u>OFF</u> : Closed Caption is off.</p> <ul style="list-style-type: none"> • The caption is not displayed when the OSD menu is active. • The Closed Caption is the function to display the dialogue, narration, and / or sound effects of a television program or other video sources. The Closed Caption availability is depending upon broadcaster and/or content.
	<p>MODE</p> <p>Select Closed Caption MODE setting from following options using ▲/▼ buttons.</p> <p>CAPTIONS ⇔ TEXT</p> <p><u>CAPTIONS</u> : Display Closed Caption.</p> <p><u>TEXT</u> : Display Text data, which is for additional information such as news reports or a TV program guide. The information covers the entire screen. Not all of the C.C. program has Text information.</p>
	<p>CHANNEL</p> <p>Select Closed Caption CHANNEL from following options using ▲/▼ buttons.</p> <p>1 ⇔ 2 ⇔ 3 ⇔ 4</p> <p style="text-align: center;">↑—————↑</p> <p><u>1</u>: Channel 1, primary channel / language</p> <p><u>2</u>: Channel 2</p> <p><u>3</u>: Channel 3</p> <p><u>4</u>: Channel 4</p> <p>The channel data may vary, depending on the content. Some channel might be used for secondary language or empty.</p>

OPTION menu

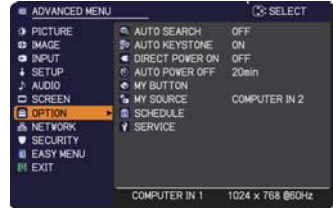



From the OPTION menu, items shown in the table below can be performed.



Select an item using the ▲/▼ cursor buttons, and press the ► cursor button or **ENTER** button to execute the item. Then perform it according to the following table.

Item	Description
AUTO SEARCH	<p>Using the ▲/▼ buttons turns on/off the automatic signal search function.</p> <p>ON ⇔ OFF</p> <p>When the ON is selected, detecting no signal automatically cycles through input ports in the following order. The search is started from the current port. Then when an input is found, the projector will stop searching and display the image.</p> <p> </p> <ul style="list-style-type: none"> • It may take several seconds to project the images from the USB TYPE B port.
AUTO KEYSTONE	<p>Using the ▲/▼ buttons turns on/off the automatic keystone function.</p> <p>ON ⇔ OFF</p> <p><u>ON</u> : Automatic keystone distortion correction will be executed whenever changing the slant of the projector.</p> <p><u>OFF</u> : This function is disabled. Please execute the AUTO KEYSTONE (EXECUTE) in the SETUP menu for automatic keystone distortion correction.</p> <ul style="list-style-type: none"> • When the projector is suspended from the ceiling this feature will not function properly so select the OFF. • This function will be unavailable when the TRANSITION DETECTOR (47) is ON or the screen is adjusted by PERFECT FIT (48).
DIRECT POWER ON	<p>Using the ▲/▼ buttons turns on/off the DIRECT POWER ON function.</p> <p>ON ⇔ OFF</p> <p>When set to the ON, the lamp in projector will be automatically turned on without the usual procedure (21), only when the projector is supplied with the power after the power was cut while the lamp was on.</p> <ul style="list-style-type: none"> • This function does not work as long as the power has been supplied to the projector while the lamp is off. • After turning the lamp on by the DIRECT POWER ON function, if neither input nor operation is detected for about 30 minutes, the projector is turned off, even though the AUTO POWER OFF function (60) is disabled.

(continued on next page)

Item	Description
<p>AUTO POWER OFF</p>	<p>Using the ▲/▼ buttons adjusts the time to count down to automatically turn the projector off.</p> <p>Long (max. 99 minutes) ⇔ Short (min. 0 minute = DISABLE)</p> <div style="display: flex; justify-content: space-around; align-items: center;">   </div> <p>When the time is set to 0, the projector is not turned off automatically. When the time is set to 1 to 99, and when the passed time with no-signal or an unsuitable signal reaches at the set time, the projector lamp will be turned off.</p> <p>If one of the projector's buttons or the remote control buttons is pressed or one of the commands (except get commands) is transmitted to the CONTROL port during the corresponding time, the projector will not be turned off.</p> <p>Please refer to the section Turning off the power (22).</p>



(continued on next page)

Item	Description
MY BUTTON	<p>This item is to assign one of the following functions to MY BUTTON 1/2 on the remote control (📖 6).</p> <p>(1) Use the ▲/▼ buttons on the MY BUTTON menu to select a MY BUTTON - (1/2) and press the ► or ENTER button to display the MY BUTTON setup dialog.</p> <p>(2) Then using the ▲/▼/◀/▶ buttons sets one of the following functions to the chosen button. Press the ENTER or INPUT button to save the setting.</p> <ul style="list-style-type: none"> • COMPUTER IN1: Selects the input from COMPUTER IN1 port. • COMPUTER IN2: Selects the input from COMPUTER IN2 port. • LAN: Selects input from LAN port. • USB TYPE A: Selects input from USB TYPE A port. • USB TYPE B: Selects input from USB TYPE B port. • HDMI1: Selects input from HDMI1 port. • HDMI2/MHL: Selects input from HDMI2/MHL port. • VIDEO: Selects the input from VIDEO port. • SLIDESHOW: Selects the input from USB TYPE A, and starts a Slideshow. • MY IMAGE: Displays the MY IMAGE menu. • MESSENGER: Turns the messenger text displayed on the screen on/off (Messenger Function in the Network Guide). When there is no transferred text data to display, the message "NO MESSENGER DATA" appears. • INFORMATION: Displays SYSTEM_INFORMATION, INPUT_INFORMATION (📖 72), WIRELESS INFORMATION, WIRED INFORMATION or nothing. • AUTO KEYSTONE : Performs automatic keystone distortion correction (📖 47). • MY MEMORY: Loads one of adjustment data stored (📖 39). When more than one data are saved, the adjustment changes every time the MY BUTTON is pressed. When no data is saved in memory, the dialog "No saved data" appears. When the current adjustment is not saved to memory, the dialog as shown in the right appears. <p>If you want to keep the current adjustment, please press the ► button to exit. Otherwise loading a data will overwrite the current adjusted condition.</p> <p>(continued on next page)</p> <div style="text-align: right;">   </div>

(continued on next page)

Item	Description
<p>MY BUTTON (Continued)</p>	<ul style="list-style-type: none"> • ACTIVE IRIS: Changes the active iris mode. • PICTURE MODE: Changes the PICTURE MODE (📖 34). • FILTER RESET: Displays the filter time reset confirmation dialogue (📖 50). • TEMPLATE: Makes the template pattern selected to the TEMPLATE item (📖 57) appear or disappear. • AV MUTE: Turns the picture and audio on/off. • RESOLUTION: Turns on/off the RESOLUTION dialog (📖 46). • MIC VOLUME: Turns on/off the MIC VOLUME dialog (📖 52). • ECO MODE: Changes the ECO MODE (📖 49). • SAVER MODE: Changes the SAVER MODE (📖 49 ECO MODE). • HDCR: Turns on/off the HDCR dialog (📖 36). • ACCENTUALIZER: Turn on/off the ACCENTUALIZER dialog (📖 36).
<p>MY SOURCE</p>	<p>Using ▲/▼ buttons selects the picture input port to be selected with pressing the MY SOURCE/DOC.CAMERA button on the remote control.</p> <p>You can use this function not only for document cameras but also computers and other equipment.</p> <p>  </p>



(continued on next page)

Item	Description								
<p>SCHEDULE</p>	<p>■ How to setup the item</p> <p>1. Use the ▲/▼/◀/▶ cursor buttons to select or adjust. 2 Select OK to finish the settings.</p> <div style="border: 1px solid black; padding: 5px; margin: 10px 0;"> <p>NOTE •Please refer to the actual on-screen display(OSD) for appropriate operation.</p> </div> <table border="1" style="width: 100%; border-collapse: collapse;"> <thead> <tr> <th style="width: 30%;">Item</th> <th>Description</th> </tr> </thead> <tbody> <tr> <td>DATE AND TIME</td> <td>Set the DATE(Year/Month/Date) and Time(24-hour scale).</td> </tr> <tr> <td>SPECIFIC DATE</td> <td>Set specific date from 1 to 10.</td> </tr> <tr> <td>PROGRAM EDIT</td> <td>The TIME and EVENT for Program 1 to 16 can be edited.</td> </tr> </tbody> </table>	Item	Description	DATE AND TIME	Set the DATE(Year/Month/Date) and Time(24-hour scale).	SPECIFIC DATE	Set specific date from 1 to 10.	PROGRAM EDIT	The TIME and EVENT for Program 1 to 16 can be edited.
	Item	Description							
	DATE AND TIME	Set the DATE(Year/Month/Date) and Time(24-hour scale).							
	SPECIFIC DATE	Set specific date from 1 to 10.							
PROGRAM EDIT	The TIME and EVENT for Program 1 to 16 can be edited.								
<p>■ How to activate (DATE AND TIME / SPECIFIC DATE)</p> <p>Place a check mark in the box.</p>									
<div style="display: flex; justify-content: space-around;"> <div style="text-align: center;"> <p>Check mark in the box</p>  </div> <div style="text-align: center;"> <p>Date and first setup info could be seen with the check mark.</p>  </div> </div> 									
<p>1/2 page (Set the DATE(Year/Month/Date) and Time(24-hour scale).)</p>									

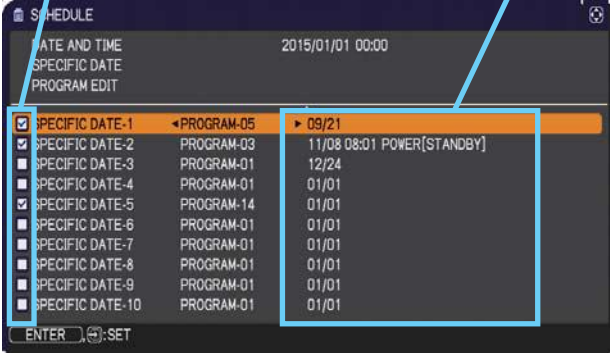
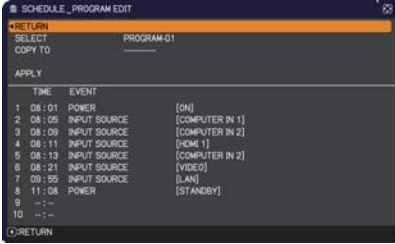

(continued on next page)

Item	Description
<p>SCHEDULE (Continued)</p>	<p>Check mark in the box</p> <p>Date and first setup info could be seen with the check mark.</p>  <p>2/2 page (Set specific date from 1 to 10.)</p> <p>Press the ▼ cursor button to move from 1/2 page to 2/2 page with the state of selecting "SATURDAY".</p> <p>■ PROGRAM EDIT</p> <p>The TIME and EVENT for Program 1 to 16 can be edited.</p> <ul style="list-style-type: none"> • RETURN Select this to go back to the top menu of the SCHEDULE. • SELECT Select from PROGRAM-01 to 16 to edit. Each PROGRAM can be setup up to 20 settings • COPY TO The selected program (with the settings of TIME and EVENT) can be copied to other program. • APPLY Select this to apply and save all adjustments and settings. 

(continued on next page)

Item	Description
<p>SCHEDULE (Continued)</p>	<p>■ How to edit the selected PROGRAM</p> <ol style="list-style-type: none"> Select from 1 to 20 events. Use the ▲/▼ cursor buttons to select. Press ► cursor button to set the TIME and EVENT. Use the ◀/▶ cursor buttons to select. Use the ◀/▶ cursor buttons to adjust.  <p>EVENT can be selected as listed below.</p> <ul style="list-style-type: none"> ◦ POWER – ON, STANDBY ◦ INPUT SOURCE – "input source"channel ◦ MY IMAGE – IMAGE-1 to 4, IMAGE OFF ◦ MESSENGER – TEXT-1 to 12, TEXT OFF ◦ ECO MODE – OFF, ECO-1, ECO-2, INTELLIGENT ECO, SAVER ◦ BLANK – ON, OFF ◦ SLIDESHOW - START, STOP  <ol style="list-style-type: none"> Press ► cursor button to finish the settings. Select APPLY to save the settings. <div style="border: 1px solid black; border-radius: 15px; padding: 10px; margin-top: 20px;"> <p>NOTE • Please refer to the actual on-screen display(OSD) for appropriate operation.</p> </div>

(continued on next page)

Item	Description
SERVICE	<p>Selecting this item displays the SERVICE menu.</p> <p>Select an item using the ▲/▼ buttons, and press the ► button or the ENTER button on the remote control to execute the item.</p> 
	<p>ALTITUDE</p> <p>Using the ▲/▼ buttons switches the rotation speed of the cooling fans. The HIGH is the mode for use at highlands etc. If the projector is used at an altitude of about 1600 m (5250 feet) or higher, select HIGH. Otherwise, select NORMAL. Note that the projector is noisier when the HIGH is selected.</p> <p>HIGH ⇄ NORMAL</p>
	<p>AUTO ADJUST</p> <p>Using the ▲/▼ buttons to select one of the mode. When the DISABLE is selected, the automatic adjustment feature is disabled.</p> <p>FINE ⇄ FAST ⇄ DISABLE</p> <p style="text-align: center;">↑—————↑</p> <p>FINE: Finer tuning including H.SIZE adjustment. FAST: Faster tuning, setting H.SIZE to prearranged data for the input signal.</p> <ul style="list-style-type: none"> Depending on conditions, such as input image, signal cable to the projector, environment around the projector, etc., the automatic adjustment may not work correctly. In such a case, please choose DISABLE to disable the automatic adjustment, and make adjustment manually.
	<p>GHOST</p> <p>Adjust the settings using the ▲/▼ buttons to eliminate ghosting.</p>
	<p>KEY LOCK</p> <p>(1) Use the ▲/▼ buttons to choose the operations control.</p> <p style="text-align: center;">CONTROL PANEL ⇄ REMOTE CONTROL</p> <p>(2) Use the ◀/▶ buttons to select ON or OFF.</p> <p style="text-align: center;">ON ⇄ OFF</p>  <p>Selecting ON in Step 2 locks the buttons except STANDBY/ON on the operations control selected in Step 1. Selecting OFF releases the locked buttons on the operations control selected in Step 1.</p> <ul style="list-style-type: none"> Please use this function to prevent tampering or accidental operation.

(continued on next page)

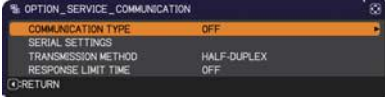
Item	Description
<p style="text-align: center;">SERVICE (continued)</p>	<p>REMOTE FREQ.</p> <p>(1) Use the ▲/▼ button to change the projector's remote sensor frequency setting (📖 19).</p> <p style="padding-left: 40px;">1:NORMAL ⇔ 2:HIGH</p> <p>(2) Use the ◀/▶ button to change the projector's remote sensor on or off.</p> <p style="padding-left: 40px;">ON ⇔ OFF</p> <p>If the remote control does not function correctly, disable either of them. It's not possible to disable both options at the same time.</p>
	<p>COMMUNICATION</p> <p>Selecting this item displays COMMUNICATION menu.</p> <p>In this menu, you can configure the serial communication settings of the projector using the CONTROL port.</p>  <ul style="list-style-type: none"> • Select an item using the cursor buttons ▲/▼. Then pressing the ▶ button opens the submenu for the setting item you selected. Or, pressing the ◀ button instead of the ▶ button makes the menu back to the previous one without changing the setup. Each submenu can be operated as described above. • When COMMUNICATION TYPE (📖 68) is set to OFF, the other items in COMMUNICATION menu are invalid. • For the function of serial communication, refer to the Network Guide.

(continued on next page)

Item	Description
<p>SERVICE (continued)</p>	<p>COMMUNICATION (continued)</p> <p>COMMUNICATION TYPE Select the communication type for transmission via the CONTROL port. <u>NETWORK BRIDGE</u>: Select this type, if it is required to control an external device as a network terminal, via this projector from the computer. The CONTROL port doesn't accept RS-232C commands (Network Bridge Function in the Network Guide) <u>OFF</u>: Select this mode to receive RS-232C commands using the CONTROL port.</p> <ul style="list-style-type: none"> • OFF is selected as the default setting. • When you select the NETWORK BRIDGE, check the item, TRANSMISSION METHOD (📖 below). <p>SERIAL SETTINGS Select the serial communication condition for the CONTROL port.</p> <p>BAUD RATE 4800bps ↔ 9600bps ↔ 19200bps ↔ 38400bps ↑ ↑</p> <p>PARITY NONE ↔ ODD ↔ EVEN ↑ ↑</p> <ul style="list-style-type: none"> • The BAUD RATE is fixed to 19200bps and PARITY is fixed NONE when the COMMUNICATION TYPE is set to OFF (📖 above). <p>TRANSMISSION METHOD Select the transmission method for communication by the NETWORK BRIDGE from the CONTROL port.</p> <p>HALF-DUPLEX ↔ FULL-DUPLEX</p> <p><u>HALF-DUPLEX</u>: This method lets the projector make two way communication, but only one direction, either transmitting or receiving data, is allowed at a time.</p> <p><u>FULL-DUPLEX</u>: This method lets the projector make two way communication, transmitting and receiving data at the same time.</p> <ul style="list-style-type: none"> • HALF-DUPLEX is selected as the default setting. • If you select HALF-DUPLEX, check the setting of the item RESPONSE LIMIT TIME (📖 69).

(continued on next page)

Item	Description	
SERVICE (continued)	COMMUNICATION (continued)	<p>RESPONSE LIMIT TIME Select the time period to wait for receiving response data from other device communicating by the NETWORK BRIDGE and the HALF-DUPLEX through the CONTROL port.</p> <p>OFF ⇔ 1s ⇔ 2s ⇔ 3s </p> <p><u>OFF</u>: Select this mode if it is not required to check the responses from the device that the projector sends data to. In this mode, the projector can send out data from the computer continuously.</p> <p><u>1s /2s /3s</u>: Select the time period to keep the projector waiting for response from the device that the projector sends data to. While waiting the response, the projector does not send out any data from the CONTROL port.</p> <ul style="list-style-type: none"> • This menu is available only when the NETWORK BRIDGE is selected for the COMMUNICATION TYPE and the HALF-DUPLEX is selected for the TRANSMISSION METHOD (▶ 68). • OFF is selected as the default setting.
	CLONING	<p>The settings of the projector can be copied via USB memory.</p> <p>SAVE:Saves each settings of the projector to USB memory.</p> <p>LOAD:Loads each settings of the projector from USB memory. Message will be displayed after loading, and power will turn off after five min. or by pressing ▶ button. (A message is displayed for a few seconds if loading fails.)</p> <p>After saving/loading, you can remove the USB storage device.</p>



(continued on next page)

Item	Description	
<p>SERVICE (continued)</p>	<p>CLONING (continued)</p>	<p>The following items are exempted. SETUP: LAMP TIME, FILTER TIME OPTION: SERVICE(GHOST), DATE AND TIME NETWORK: WIRELESS AND WIRED SETUP (IP ADDRESS, SUBNET MASK, DEFAULT GATEWAY), MY IMAGE, PRESENTATION, AMX D.D. SECURITY: MY TEXT DISPLAY</p> <ul style="list-style-type: none"> • Operation is not available if SECURITY_ CLONNING LOCK is turned ON. • The Screen_MyScreen can only be loaded. <p><u>CLONING load function on STANDBY MODE</u></p> <ul style="list-style-type: none"> • While the projector is in STANDBY MODE, push the INPUT button of control panel together with ► button, and then press ▲ button to start operating the CLONING load function. • During loading process, the three indicators of control panel (POWER (orange), TEMP, LAMP) will remain on. • After the loading process, the three indicators (POWER (orange), TEMP, LAMP) will turn off. Then, you can remove the USB storage device. • If the loading fails, the three indicators (POWER (orange), TEMP, LAMP) will blink at the same time. • CLONING is invalid with the following conditions. <ul style="list-style-type: none"> - CLONING LOCK is turned ON. With this condition, the three indicators (POWER (orange), TEMP, LAMP) will blink at approximately three seconds intervals. - If the STANDBY MODE is set to SAVING. - If there is no USB memory inserted into USB TYPE A port. - If PIN LOCK or lock of TRANSITION DETECTOR is not being released. - If a system error occurs. • Please operate one of the following after loading. <ul style="list-style-type: none"> - Press INPUT button and ◀ button of the control panel at the same time. - Wait at least five min. after loading. - Restart the projector after re-plugging the AC cable.

(continued on next page)

Item	Description	
SERVICE (continued)	CLONING (continued)	<p><u>Load MyScreen data</u></p> <ul style="list-style-type: none"> • Please save the image data as "pj_logo.bmp" or "pj_logo.gif" into USB memory. • Please note that the only compatible formats are as follows. <p>-File format</p> <p style="padding-left: 20px;"><u>Windows BMP</u> bit/pixel: 4/8/16/24/32bit</p> <p style="padding-left: 20px;"><u>Compression format</u> :</p> <p style="padding-left: 20px;">Without compression/RLE</p> <p style="padding-left: 20px;"><u>GIF</u></p> <p>-Image size: more than 36x36, less than 1280x800</p> <ul style="list-style-type: none"> • If two kinds of file format are saved, "pj_logo.bmp" will be registered into MyScreen data. • If MyScreen LOCK or MyScreen PASSWORD is turned ON, the data of MyScreen cannot be loaded. <p><u>Setting the data</u></p> <ul style="list-style-type: none"> • Operating the SAVE function under CLONING will name the file as "pj_data.bin" into the USB memory. Please do not attempt to change the file name or the folder structure. • If a file with the same name already exists, it will be overwritten by operating the SAVE function. <p><u>Loading function</u></p> <ul style="list-style-type: none"> • Please note that saved data from other model cannot be loaded. • Please note that, if any of the following functions: MyScreen PASSWORD, PIN LOCK, TRANSITION DETECTOR, MY TEXT PASSWORD under SECURITY menu or MyScreen Lock under SCREEN menu is ON, the respective saved data cannot be loaded. • Please note that the saved settings of KEYSTONE (SETUP menu) and AUTO KEYSTONE (OPTION menu) cannot be loaded when TRANSITION DETECTOR (SECURITY menu) is ON. • Please note that the saved data of START UP and MyScreen Lock under SCREEN menu cannot be loaded if MyScreen PASSWORD under SECURITY menu is ON. • Please note that the saved data of MY TEXT WRITING cannot be loaded if MY TEXT PASSWORD under SECURITY menu is ON.

(continued on next page)

Item	Description
<p>SERVICE (continued)</p>	<p>INFORMATION Selecting this item displays a dialog titled “INPUT_INFORMATION”. It shows the information about the current input.</p> <div style="display: flex; justify-content: space-around; align-items: center;">    </div> <ul style="list-style-type: none"> • The “FRAME LOCK” message on the dialog means the frame lock function is working. • This item can't be selected for no signal and sync out. • When the MY TEXT DISPLAY is set to ON, the MY TEXT is displayed together with the input information in the INPUT_INFORMATION box (📖79).
	<p>FACTORY RESET Selecting OK using the ► button performs this function. By this function, all the items in all of menus will collectively return to the initial setting. Note that the items AUTO BLANK, STANDBY MODE, LAMP TIME, FILTER TIME, LANGUAGE, FILTER MESSAGE, NETWORK and SECURITY settings are not reset.</p> <p>CANCEL ⇨ OK Be sure to set ALTITUDE after resetting all the settings (📖66).</p>

NETWORK menu

See the **Network Guide** for details of NETWORK operation. Remember that incorrect network settings on this projector may cause trouble on the network. Be sure to consult with your network administrator before connecting to an existing access point on your network.

SECURITY menu

This projector is equipped with security functions.

From the SECURITY menu, items shown in the table below can be performed.

To use SECURITY menu: User registration is required before using the security functions.

Enter to the SECURITY menu

1. Press the ► button. The ENTER PASSWORD box will be displayed.
2. Use the ▲/▼/◀/▶ buttons to enter the registered password.

The factory default password is as follows.

CP-X2542WN/CP-X3042WN/CP-X4042WN : 3033
 CP-WX3042WN/CP-WX4042WN : 7430

This password can be changed (below). Move the cursor to the right side of the ENTER PASSWORD box and press the ► button to display the SECURITY menu.



- It is strongly recommended the factory default password to be changed as soon as possible.
- If an incorrect password is input, the ENTER PASSWORD box will be displayed again. If incorrect password is input 3 times, the projector will turn off. Afterwards the projector will turn off every time an incorrect password is input.

3. Items shown in the table below can be performed.



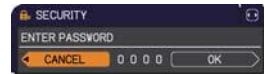

If you have forgotten your password

- (1) While the ENTER PASSWORD box is displayed, press and hold the **RESET** button on the remote control for about 3 seconds or press and hold the **INPUT** button for 3 seconds while pressing the ► button on the projector.
 - (2) The 10 digit Inquiring Code will be displayed. Contact your dealer with the 10 digit Inquiring Code. Your password will be sent after your user registration information is confirmed.
- If there is no key input for about 55 seconds while the Inquiring Code is displayed, the menu will close. If necessary, repeat the process from (1).





Item	Description
SECURITY PASSWORD CHANGE	<ol style="list-style-type: none"> (1) Use the ▲/▼ buttons on the SECURITY menu to select SECURITY PASSWORD CHANGE and press the ► button to display the ENTER NEW PASSWORD box.  (2) Use the ▲/▼/◀/▶ buttons to enter the new password. (3) Move the cursor to the right side of the ENTER NEW PASSWORD box and press the ► button to display the NEW PASSWORD AGAIN box, enter the same password again.  (4) Move the cursor to the right side of the NEW PASSWORD AGAIN box and press the ► button and the NOTE NEW PASSWORD box will be displayed for about 30 seconds, please make note of the password during this time. Pressing the ENTER button on the remote control or ► button on the projector will close the NOTE NEW PASSWORD box.  <ul style="list-style-type: none"> • Please do not forget your password.





(continued on next page)

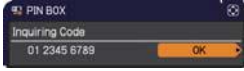



Item	Description
<p>MyScreen PASSWORD</p>	<p>The MyScreen PASSWORD function can be used to prohibit access to the MyScreen function and prevent the currently registered MyScreen image from being overwritten.</p> <p>1 Turning on the MyScreen PASSWORD</p> <p>1-1 Use the ▲/▼ buttons on the SECURITY menu to select MyScreen PASSWORD and press the ► button to display the MyScreen PASSWORD on/off menu.</p>  <p>1-2 Use the ▲/▼ buttons on the MyScreen PASSWORD on/off menu to select ON. The ENTER NEW PASSWORD box (small) will be displayed.</p>  <p>1-3 Use the ▲/▼/◀/▶ buttons to enter the password. Move the cursor to the right side of the ENTER NEW PASSWORD box (small) and press the ► button to display the NEW PASSWORD AGAIN box, enter the same PASSWORD again.</p>  <p>1-4 Move the cursor to the right side of the NEW PASSWORD AGAIN box and press the ► button to display the NOTE NEW PASSWORD box for about 30 seconds, please make note of the password during this time.</p>  <p>Pressing the ENTER button on the remote control or ► button on the projector will return to MyScreen PASSWORD on/off menu.</p> <p>When a password is set for MyScreen:</p> <ul style="list-style-type: none"> • The MyScreen registration function (and menu) will be unavailable. • The MyScreen Lock menu will be unavailable. • The START UP setting will be locked on MyScreen (and the menu will be unavailable). <p>Turning the MyScreen PASSWORD off will allow normal operation of these functions.</p> <ul style="list-style-type: none"> • Please do not forget your MyScreen PASSWORD. <p>2 Turning off the MyScreen PASSWORD</p> <p>2-1 Follow the procedure in 1-1 to display the MyScreen PASSWORD on/off menu.</p> <p>2-2 Select OFF to display the ENTER PASSWORD box (large). Enter the registered password and the screen will return to the MyScreen PASSWORD on/off menu.</p>  <p>If an incorrect PASSWORD is input, the menu will close. If necessary, repeat the process from 2-1.</p> <p>3 If you have forgotten your password</p> <p>3-1 Follow the procedure in 1-1 to display the MyScreen PASSWORD on/off menu.</p> <p>3-2 Select OFF to display the ENTER PASSWORD box (large). The 10 digit Inquiring Code will be displayed inside the box.</p> <p>3-3 Contact your dealer with the 10 digit Inquiring Code. Your password will be sent after your user registration information is confirmed.</p>

(continued on next page)

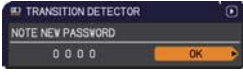
Item	Description
<p>PIN LOCK</p>	<p>PIN LOCK is a function which prevents the projector from being used unless a registered Code is input.</p> <p>1 Turning on the PIN LOCK</p> <p>1-1 Use the ▲/▼ buttons on the SECURITY menu to select PIN LOCK and press the ► button or the ENTER button to display the PIN LOCK on/off menu.</p>  <p>1-2 Use the ▲/▼ buttons on the PIN LOCK on/off menu to select ON and the Enter PIN Code box will be displayed.</p>  <p>1-3 Input a 4 part PIN code using the ▲/▼/◀/▶, COMPUTER or INPUT button. The PIN Code again box will appear. Reenter the same PIN code. This will complete the PIN code registration.</p>  <ul style="list-style-type: none"> • If there is no key input for about 55 seconds while the Enter PIN Code box or the PIN Code again box is displayed, the menu will close. If necessary, repeat the process from 1-1. <p>Afterwards, anytime the projector is restarted after AC power is turned off the Enter PIN Code box will be displayed. Enter the registered PIN code. The projector can be used after entering the registered PIN code. If an incorrect PIN code is input, the Enter PIN code box will be displayed again. If an incorrect PIN code is input 3 times, the projector will turn off. Afterwards the projector will turn off every time an incorrect PIN code is input. The projector will also turn off if there is no key input for about 5 minutes while the Enter PIN code box is displayed. This function will activate only when the projector is started after AC power is turned off.</p> <ul style="list-style-type: none"> • Please do not forget your PIN code. <p>2 Turning off the PIN LOCK</p> <p>2-1 Follow the procedure in 1-1 to display the PIN LOCK on/off menu.</p> <p>2-2 Use the ▲/▼ buttons to select OFF and the Enter PIN Code box will be displayed.</p> <p>Enter the registered PIN code to turn the PIN LOCK function off. If an incorrect PIN code is input 3 times, the projector will turn off.</p> <p>3 If you have forgotten your PIN code</p> <p>3-1 While the Enter PIN code box is displayed, press and hold the RESET button for three seconds or press and hold the INPUT button for 3 seconds while pressing the ► button on the projector. The 10 digit Inquiring Code will be displayed.</p> <ul style="list-style-type: none"> • If there is no key input for about 5 minutes while the Inquiring Code is displayed, the projector will turn off.  <p>3-2 Contact your dealer with the 10 digit Inquiring Code. Your PIN code will be sent after your user registration information is confirmed.</p>

(continued on next page)

Item	Description
<p>TRANSITION DETECTOR</p>	<p>If this function is set to ON and the vertical angle of the projector or the INSTALLATION setting is different from the previous recorded setting, the TRANSITION DETECTOR ON alarm will be displayed and the input signal will not be displayed.</p> <ul style="list-style-type: none"> • To display the signal again, set this function OFF. • After about 5 minutes of displaying the TRANSITION DETECTOR ON alarm, the lamp will turn off. • Keystone adjustment feature has been prohibited as long as the TRANSITION DETECTOR function is on. <p>1 Turning on the TRANSITION DETECTOR</p> <p>1-1 Use the ▲/▼ buttons on the SECURITY menu to select TRANSITION DETECTOR and press the ► or the ENTER button to display the TRANSITION DETECTOR on/off menu.</p>  <p>1-2 Use the ▲/▼ buttons on the TRANSITION DETECTOR on/off menu to select ON. Selecting ON will save the setting of the current angle and the INSTALLATION setting. The ENTER NEW PASSWORD box (small) will be displayed.</p>  <p>1-3 Use the ▲/▼/◀/▶ buttons to enter a password. Move the cursor to the right side of the ENTER NEW PASSWORD box (small) and press the ► button to display the NEW PASSWORD AGAIN box, enter the same password again.</p>  <p>1-4 Move the cursor to the right side of the NEW PASSWORD AGAIN box and press the ► button to display the NOTE NEW PASSWORD box for about 30 seconds, please make note of the password during this time.</p>  <p>Pressing the ENTER button on the remote control or the ► button on the projector will return to the TRANSITION DETECTOR on/off menu.</p> <ul style="list-style-type: none"> • Please do not forget your TRANSITION DETECTOR password. • This function will activate only when the projector is started after turning off the AC power. • This feature may not function properly if the projector is not in a stable position when ON is selected. <p>2 Turning off the TRANSITION DETECTOR</p> <p>2-1 Follow the procedure in 1-1 to display the TRANSITION DETECTOR on/off menu.</p> <p>2-2 Select OFF to display the ENTER PASSWORD box (large). Enter the registered password and the screen will return to the TRANSITION DETECTOR on/off menu.</p>  <p>If an incorrect password is input, the menu will close. If necessary, repeat the process from 2-1.</p> <p>3 If you have forgotten your password</p> <p>3-1 Follow the procedure in 1-1 to display the TRANSITION DETECTOR on/off menu.</p> <p>3-2 Select OFF to display the ENTER PASSWORD box (large). The 10 digit Inquiring Code will be displayed inside the box.</p> <p>3-3 Contact your dealer with the 10 digit Inquiring Code. Your password will be sent after your user registration information is confirmed.</p>

Item	Description
MY TEXT PASSWORD	<p>The MY TEXT PASSWORD function can prevent the MY TEXT from being overwritten. When the password is set for the MY TEXT;</p> <ul style="list-style-type: none"> • The MY TEXT DISPLAY menu will be unavailable, which can prohibit changing the DISPLAY setting. • The MY TEXT WRITING menu will be unavailable, which can prevent the MY TEXT from being overwritten. <p>1 Turning on the MY TEXT PASSWORD</p> <p>1-1 Use the ▲/▼ buttons on the SECURITY menu to select the MY TEXT PASSWORD and press the ► button to display the MY TEXT PASSWORD on/off menu.</p>  <p>1-2 Use the ▲/▼ buttons on the MY TEXT PASSWORD on/off menu to select ON. The ENTER NEW PASSWORD box (small) will be displayed.</p>  <p>ENTER NEW PASSWORD box (small)</p> <p>1-3 Use the ▲/▼/◀/▶ buttons to enter the password. Move the cursor to the right side of the ENTER NEW PASSWORD box (small) and press the ► button to display the NEW PASSWORD AGAIN box, and then enter the same password again.</p>  <p>1-4 Move the cursor to the right side of the NEW PASSWORD AGAIN box and press ► button to display the NOTE NEW PASSWORD box for about 30 seconds, then please make note of the password during this time.</p>  <p>Pressing the ENTER button on the remote control or ► button on the projector will return to the MY TEXT PASSWORD on/off menu.</p> <p>2 Turning off the MY TEXT PASSWORD</p> <p>2-1 Follow the procedure in 1-1 to display the MY TEXT PASSWORD on/off menu.</p> <p>2-2 Select OFF to display the ENTER PASSWORD box (large). Enter the registered password and the screen will return to the MY TEXT PASSWORD on/off menu.</p>  <p>ENTER PASSWORD box (large)</p> <p>If an incorrect password is input, the menu will close. If necessary, repeat the process from 2-1</p> <p>3 If you have forgotten your password</p> <p>3-1 Follow the procedure in 1-1 to display the MY TEXT PASSWORD on/off menu.</p> <p>3-2 Select OFF to display the ENTER PASSWORD box (large). The 10 digit inquiring code will be displayed inside the box.</p> <p>3-3 Contact your dealer with the 10 digit inquiring code. Your password will be sent after your user registration information is confirmed.</p>

(continued on next page)

Item	Description
<p>MY TEXT DISPLAY</p>	<p>(1) Use the ▲/▼ buttons on the SECURITY menu to select the MY TEXT DISPLAY and press the ► or ENTER button to display the MY TEXT DISPLAY on/off menu.</p> <p>(2) Use the ▲/▼ buttons on the MY TEXT DISPLAY on/off menu to select on or off.</p> <p>ON ⇄ OFF</p> <p>When it is set ON, the MY TEXT will be displayed on the START UP screen and the INPUT_INFORMATION when the INFORMATION on the SERVICE menu is chosen.</p> <ul style="list-style-type: none"> • This function is available only when the MY TEXT PASSWORD function is set to the OFF.
<p>MY TEXT WRITING</p>	<p>(1) Use the ▲/▼ buttons on the SECURITY menu to select the MY TEXT WRITING and press the ► button. The MY TEXT WRITING dialog will be displayed.</p> <p>(2) The current MY TEXT will be displayed on the first 3 lines. If not yet written, the lines will be blank.</p> <p>Use the ▲/▼/◀/▶ buttons and the ENTER or INPUT button to select and enter characters. To erase 1 character at one time, press the RESET button or press the ◀ and INPUT button at the same time. Also if you move the cursor to DELETE or ALL CLEAR on screen and press the ENTER or INPUT button, 1 character or all characters will be erased. The MY TEXT can be input up to 24 characters on each line.</p> <p>(3) To change an already inserted character, press the ▲/▼ button to move the cursor to one of the first 3 lines, and use the ◀/▶ buttons to move the cursor on the character to be changed.</p> <p>After pressing the ENTER or INPUT button, the character is selected.</p> <p>Then, follow the same procedure as described at the item (2) above.</p> <p>(4) To finish entering text, move the cursor to the OK on screen and press the ►, ENTER or INPUT button. To revert to the previous MY TEXT without saving changes, move the cursor to the CANCEL on screen and press the ◀, ENTER or INPUT button.</p> <ul style="list-style-type: none"> • The MY TEXT WRITING function is available only when the MY TEXT PASSWORD function is set to OFF.
<p>CLONING LOCK</p>	<p>The CLONING operation under OPTION_SERVICE menu is not available if ON is selected.</p>

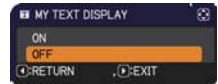

Presentation tools

The projector has the following convenient tools that enable on-screen presentations easily and quickly:

- PC-LESS Presentation ([📖 below](#))
- Drawing function

Drawing function enables you to draw on the projector's screen with USB mouse or tablets connected to the **USB TYPE A** ports. For details, refer to the manual for peripheral equipment.

- USB Display ([📖 90](#))

PC-LESS Presentation

The PC-LESS Presentation reads image and audio data from the storage media inserted into the **USB TYPE A** port and displays the image in the following modes. The PC-LESS Presentation can be started by selecting the **USB TYPE A** port as the input source.

This feature allows you to make your presentations without using your computer.

- Thumbnail mode ([📖 81](#))
- Full Screen mode ([📖 85](#))
- Slideshow mode ([📖 87](#))

[Supported storage media]

- USB memory (USB memory type, USB hard disk and USB card reader type)

NOTE

- USB readers (adapters) that have more than one USB slot may not work (if the adapter is acknowledged as multiple devices connected).
- USB devices with security software may not work.
- Be careful when inserting or removing a USB device. ([📖 13, 83](#))

[Supported format]

- FAT12, FAT16 and FAT32

NOTE

- NTFS is not supported.

PC-LESS Presentation (continued)

[Supported file format and its extension]

- JPEG (.jpeg, .jpg) * Progressive is not supported.
- Bitmap (.bmp) * 16bit mode and compressed bitmap is not supported.
- PNG (.png) * Interlace PNG is not supported.
- GIF (.gif)
- Movie (.avi, .mov) * Supported video format: Motion-JPEG
Supported audio format: WAV (Linear PCM, Stereo 16bit),
IMA-ADPCM

NOTE • Files with a resolution larger than the following are not supported.
 CP-X2542WN/CP-X3042WN/CP-X4042WN: 1024 x 768 (Still), 768 x 576 (Movie)
 CP-WX3042WN/CP-WX4042WN: 1280 x 800 (Still), 768 x 576 (Movie)
 (* Some computers may not support 1280 x 800.)

- Files with a resolution smaller than 36 x 36 are not supported.
- Files with a resolution smaller than 100 x 100 may not be displayed.
- Movie images with a frame rate higher than 15 fps cannot be displayed.
- Movie images with a bit rate higher than 20 Mbps cannot be displayed.
- Some supported files may not be displayed.
- Only a frame appears when the content of image data cannot be displayed in the Thumbnail mode.
- Even with the file format and audio format combinations described above, playback of some files may fail.

Thumbnail mode

The Thumbnail mode displays the images stored in a USB storage device on the Thumbnail screen. Maximum 20 images are displayed in a screen.

If you wish, you can jump into the Full Screen mode or Slideshow mode, after you select some images in the Thumbnail mode.

The Thumbnail mode will be started as the primary function of the PC-LESS Presentation after selecting the **USB TYPE A** port as the input source.



PC-LESS Presentation (continued)

Operating by buttons or keys

You can control the images on the Thumbnail screen with the remote control, control panel or Web Remote Control. The following functions can be supported while the Thumbnail is displayed.





Button operation			Functions
The remote control	Control panel	Web Remote Control	
▲/▼/◀/▶	▲/▼/◀/▶	[▲]/[▼]/[◀]/[▶]	Move cursor
PAGE UP PAGE DOWN	-	[PAGE UP] [PAGE DOWN]	Switches pages
ENTER	INPUT	[ENTER]	<ul style="list-style-type: none"> • Displays the selected image on the Full Screen mode when a cursor is on a thumbnail image. • Displays the SETUP menu (🔗 89 below) for the selected image when a cursor is on a thumbnail image number.

The SETUP menu for the selected image





Item	Functions
SETUP	Use the ◀/▶ cursor buttons to switch each setting or use the ▶ cursor button to execute the functions as follows.
RETURN	Press the ▶ cursor button or ENTER to return to the Thumbnail screen.
START	Switch to ON to set the selected image as the first image in the Slideshow. This setting information will be saved in the "playlist.txt" file (🔗 89).
STOP	Switch to ON to set the selected image as the last image in the Slideshow. This setting information will be saved in the "playlist.txt" file (🔗 89).
SKIP	Switch to ON to skip the selected image in the Slideshow. This setting information will be saved in the "playlist.txt" file (🔗 89).
ROTATE	Press the ▶ cursor or ENTER button to rotate the selected still image 90 degrees clockwise. This setting information will be saved in the "playlist.txt" file (🔗 89).

PC-LESS Presentation (continued)**Operating by the menu on the Thumbnail screen**

You can also control the images by using the menu on the Thumbnail screen.

Item	Functions
	Moves to an upper folder.
SORT	Allows you to sort files and folders as following.
RETURN	Press the ► cursor button or ENTER to return to the Thumbnail screen.
NAME UP	Sorts in ascending order by file name.
NAME DOWN	Sorts in descending order by file name.
DATE UP	Sorts in ascending order by file date.
DATE DOWN	Sorts in descending order by file date.
▲ / ▼	Go to previous / next page.
SLIDESHOW	Configures and starts the Slideshow ( 87).
RETURN	Press the ► cursor button or ENTER to return to the Thumbnail screen.
PLAY	Press the ► cursor button or ENTER to start the Slideshow.
START	Sets the beginning number of the Slideshow.
STOP	Sets the end number of the Slideshow.
INTERVAL	Sets the interval time for displaying still images during the Slideshow.
PLAY MODE	Selects the Slideshow mode.
INPUT	Switches the input port.
MENU	Displays the menu.
REMOVE USB	Be sure to use this function before removing USB storage device from the projector. After that, the projector will not recognize a USB storage device until you insert it again into the USB TYPE A input port.
 / 	Turns the sound on/off for files that contain audio data.

PC-LESS Presentation (continued)

- NOTE
- These operations are not accessible while the projector OSD is displayed.
 - The Thumbnail mode is able to display up to 20 files in one page.
 - It is not possible to change the input port by using the **INPUT** button when the Thumbnail screen, Slideshow, or Full Screen is displayed.
 - The image quality may deteriorate when playing back audio data included in a movie. If you want to give priority to the image quality, turn off the sound by setting  to off.
 - If one of the **AUDIO IN** ports is selected or  is selected for USB TYPE A in AUDIO SOURCE of the AUDIO menu ( 52),  cannot be operated.
 - Some error icons will be displayed in the Thumbnail.



————— This file seems to be broken or not supported format.



} A file that cannot be displayed on the thumbnail screen is indicated by a file format icon.

PC-LESS Presentation (continued)**Full Screen Mode**

The Full Screen mode shows a full display image. To display in Full Screen mode, select an image in the Thumbnail screen. Then press the **ENTER** button on the remote control, the **INPUT** button on the control panel or click **[ENTER]** on the Web Remote Control.



} Full screen display

Operations for still images

The following operations are enabled in the Full Screen mode while a still image is displayed.

Button operation			Functions
The remote control	Control panel	Web Remote Control	
▼ ▶ or PAGE DOWN	▼ or ▶	[▼] [▶] or [PAGE DOWN]	Shows the next file.
▲ ◀ or PAGE UP	▲ or ◀	[▲] [◀] or [PAGE UP]	Shows the previous file.
ENTER	INPUT	[ENTER]	Displays Thumbnail.

PC-LESS Presentation (continued)**Operations for movie**

A remote control icon and a progress bar are displayed when one of the cursor buttons, **ENTER** button or **INPUT** button on the remote control, control panel or Web Remote Control is pressed or clicked while a movie is playing in the Full Screen mode. The following operations are enabled while the remote control icon and progress bar are displayed.

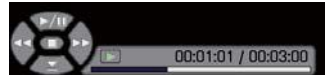

Button operation			Functions
The remote control	Control panel	Web Remote Control	
▲	▲	[▲]	(Play) / (Pause) toggle
▶	▶	[▶]	(FF) Fast-forward
◀	◀	[◀]	(REW) Fast-rewind
ENTER	INPUT	[ENTER]	(Stop), Displays Thumbnail.
PAGE DOWN	–	[PAGE DOWN]	Shows the next file.
PAGE UP	–	[PAGE UP]	Shows the previous file.

NOTE • These operations are not accessible while the projector OSD is displayed.
 • It is not possible to change the input port by using the **INPUT** button when the Thumbnail screen, Slideshow, or Full Screen is displayed.

PC-LESS Presentation (continued)

Slideshow mode

The Slideshow mode displays images in full screen and switches the images at intervals set in INTERVAL on the Thumbnail screen menu (📖83).

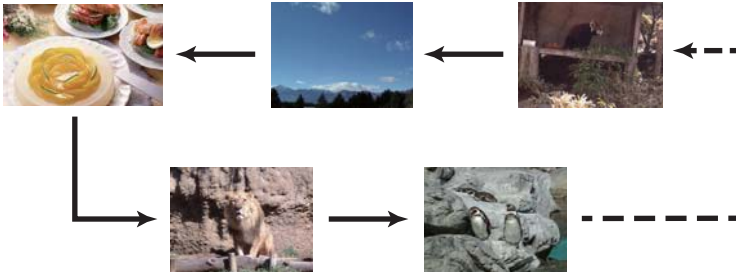

You can start this function from the Slideshow menu. To display the Slideshow menu, select the SLIDESHOW button in the Thumbnail mode and press the **ENTER** button on the remote control, **INPUT** button on the control panel, or click **[ENTER]** on the Web Remote Control.

While the Slideshow is displayed, the following button operations are enabled when still images are displayed, and the same button operations in the Full Screen mode are enabled when movies are displayed.

Button operation			Functions
The remote control	Control panel	Web Remote Control	
ENTER	INPUT	[ENTER]	Displays thumbnail

NOTE • These operations are not accessible while the projector OSD is displayed.

- It is not possible to change the input port by using the **INPUT** button when the Thumbnail screen, Slideshow, or Full Screen is displayed.
- When the Slideshow mode is set to ONE TIME and the last file is a still image, the last slide of the presentation will remain displayed until the **ENTER** button on the remote control or Web Remote Control, or the **INPUT** button on the control panel is pressed.

PC-LESS Presentation (continued)

You can play the Slideshow at your desired configuration. Configure the Slideshow items in the Thumbnail.

- 1) RETURN : Returns to the thumbnail mode.
- 2) PLAY : Play the Slideshow.
- 3) START : Set the beginning number of the Slideshow.
- 4) STOP : Set the end number of the Slideshow.
- 5) INTERVAL : Sets the interval time for displaying still images during the Slideshow.
It is not recommend to set the interval time very short something like several seconds, because it may take more than several seconds to read and display an image file if it is stored in very deep layer directory or if so many files are stored in the same directory.
- 6) PLAY MODE : Select the Slideshow mode.
ONE TIME : Play the Slideshow one time.
ENDLESS : Play the Slideshow endless.

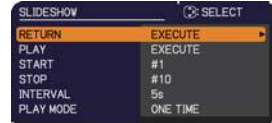

NOTE • The settings of the Slideshow are saved to the “**playlist.txt**” file that is stored in the storage media. If the file is not existed, it is generated automatically.

- The settings for the START, STOP, INTERVAL, and PLAY MODE are saved to the Playlist.
- If the storage media is under the write protection or the “**playlist.txt**” is the read only type file, it is impossible to change the settings of the Slideshow.

PC-LESS Presentation (continued)**Playlist**

The Playlist is a DOS format text file, which decides the order of displayed still image files in the Thumbnail or Slideshow.

The playlist file name is “playlist.txt” and it can be edited on a computer.

It is created in the folder that contains the selected image files when the PC-LESS Presentation is started or the Slideshow is configured.

[Example of “playlist.txt” files]

START setting : STOP setting : INTERVAL setting : PLAY MODE setting :

img001.jpg: : :

img002.jpg:600: : :

img003.jpg:700:rot1: :

img004.jpg: : :SKIP:

img005.jpg:1000:rot2:SKIP:

The “playlist.txt” file contains the following information.

Each piece of information requires to be separated by “:”, and “.” at the end of each line.

1st line: START, STOP, INTERVAL and PLAY MODE settings ( 88).

2nd line and after: file name, interval time, rotation setting and skip setting.

interval time: It can be set from 0 to 999900 (ms) with an increment of 100 (ms).

rotation setting: “rot1” means a rotation at 90 degrees clockwise; “rot2” and

“rot3” increase another 90 degrees in order.

skip setting: “SKIP” means that the image will not be displayed in the Slideshow.

- NOTE** • The maximum length in a line on the “playlist.txt” file is 255 characters including linefeed. If any line exceeds the limit, the “playlist.txt” file becomes invalid.
- Up to 999 files can be registered to the Playlist. However, if some folders exist in the same directory the limit number is decreased by the number of folders. Any files over the limit will not be shown in the Slideshow.
 - If the storage device is protected or does not have sufficient space, the “playlist.txt” file cannot be created.
 - For the Slideshow settings, refer to the section **Slideshow mode** ( 87).

USB Display(Windows computer)

The projector can display images transferred from a computer via an USB cable (📖 12).

Hardware and software requirement for computer

- **OS:** One of the following.
Windows Vista® Home Basic /Home Premium /Business /Ultimate /Enterprise
Windows® 7 Starter /Home Basic /Home Premium /Professional / Ultimate / Enterprise
Windows® 8/8.1 / Windows® 8/8.1 Pro / Windows® 8/8.1 Enterprise
- **CPU:** Pentium 4 (2.8 GHz or higher)
- **Graphic card:** 16 bit, XGA or higher
- **Memory:** 512 MB or higher
- **Hard disk space:** 30 MB or higher
- **USB Port**
- **USB cable :** 1 piece

Starting USB Display

When you connect your computer to the **USB TYPE B** port on the projector using a USB cable, the projector will be recognized as a CD-ROM drive on your computer. Then, the software in the projector, "LiveViewerLiteForUSB.exe", will run automatically and the application, "LiveViewer Lite for USB", will be ready on your computer for the USB Display. The application, "LiveViewer Lite for USB", will close automatically when the USB cable is unplugged. However, it may remain displayed at times.

NOTE • If the software does not start automatically (this is typically because CD-ROM autorun is disabled on your OS), follow the instructions below.

(1) Click on the [Start] button on the toolbar and select the "Run"

(2) Enter F:\LiveViewerLiteForUSB.exe and then press the [OK]

↑ — If your CD-ROM drive is not drive F on your computer, you will need to replace F with the correct drive letter assigned to your CD-ROM drive.

- CD-ROM autorun is disabled while the screen saver is running.
- The image transmission from the computer is suspended while the password-protected screen saver is running. To resume the transmission, exit the screen saver.
- If "Waiting for connection." remains displayed while the USB cable is connected, remove the USB cable and reconnect after a while.
- Check our web site for the latest version of the software and its manual.

(📖 **User's Manual (concise)**)

Follow the instructions that can be obtained at the site for updating.

USB Display(Windows computer) (continued)

This application will appear in the Windows notification area once it starts. You can quit the application from your computer by selecting “Quit” on the menu.



NOTE • The “LiveViewer” (refer to the **Network Guide**) and this application cannot be used at the same time. If you connect your computer to the projector by using a USB cable

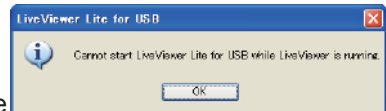

while the “LiveViewer” is running, the following message will be displayed.

- Depending on the software installed on your computer, images on your computer cannot be transferred using “LiveViewer Lite for USB”.
- If any application software having the firewall function is installed into your computer, make the firewall function invalid with following the user's manual.
- Some security software may block image transmission. Please change the security software setting to allow the use of "LiveViewer Lite for USB".
- When the audio input from **USB TYPE B** is selected, if the sound level is still low even after raising the volume level in the projector to the maximum, check whether your computer outputs audio and raise the volume level accordingly.
- If the computer in use is equipped with **HDMI1** or **HDMI2/MHL** port, the audio setting will be changed and sound interruption or noise may occur when the HDMI™ cable is connected or disconnected during USB Display. Restart USB Display for this case.
- Image distortion or sound interruption may occur when “LiveViewer” is connected to **LAN** (wireless or wired) during USB Display. The above decline in performance is noticeable especially when multiple computers are connected to “LiveViewer”.

USB Display(Windows computer) (continued)

Right-Click menu

The menu shown in the right will be displayed when you right-click the application icon in the Windows notification area.



Display : The Floating menu is displayed, and the icon disappears from the Windows notification area.

Quit : The application is closed, and the icon disappears from the Windows notification area.

NOTE • If you wish to restart the application, you need to unplug the USB cable and plug it again.

Floating menu

If you select “Display” on the Right-Click menu, the Floating menu shown in the right will appear on your computer screen.

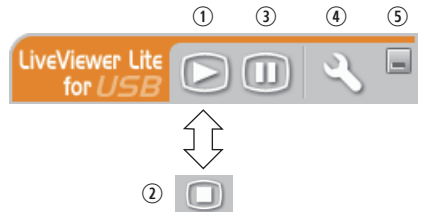

- ① **Start capture button**
The transmission to the projector is started and the images will be displayed.
- ② **Stop button**
The image transmission is stopped.
- ③ **Hold button**
The image on the projector’s screen is temporarily frozen. The last image before the button is clicked is remained on the screen. You can revise the image data on your computer without showing it on the projector’s screen.
- ④ **Option button**
The Options window is displayed.
- ⑤ **Minimize button**
The Floating menu is closed, and the icon reappears in the Windows notification area.

NOTE • If you click the Start capture button and/or Stop button repeatedly, images may not be displayed on the screen.

USB Display(Windows computer) (continued)

Options window

If you select the Option button on the Floating menu, the Options window is displayed.

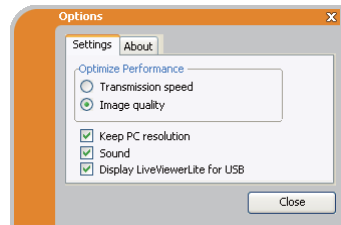

Optimize Performance

The “LiveViewer Lite for USB” captures screenshots in JPEG data and sends them to the projector. The “LiveViewer Lite for USB” has two options that have different compression rate of JPEG data.

Transmission speed

Speed takes priority over Image quality.

It makes JPEG compression rate higher.

The screen on the projector is rewritten quicker because the transferred data is smaller, but the image quality is worse.

Image quality

Image quality takes priority over Speed.

It makes JPEG compression rate lower.

The screen on the projector is rewritten slower because the transferred data is larger, but the image quality is better.

Keep PC resolution

If you remove the check mark from the [**Keep PC resolution**] box, the screen resolution of your computer will be switched as follows, and the display speed may be faster.

CP-X2542WN/CP-X3042WN/CP-X4042WN: 1024 x 768 (XGA)

CP-WX3042WN/CP-WX4042WN: 1280 x 800 (WXGA)

If your computer does not support the display resolution specified above, a smaller resolution that is the largest among the resolutions that are supported by the computer will be selected.

Sound

Turns the sound on/off. The image quality may deteriorate when you play back audio data transferred together with the image data. To give priority to the image quality, turn off the sound by selecting the checkbox.



Display LiveViewer Lite for USB

If you want to display the "LiveViewer Lite for USB" application window on the screen, please check the box.

About

The version information of the “LiveViewer Lite for USB”.

NOTE • When the resolution is changed, the arrangement of icons on computer desktop screen may be changed.

• If one of the **AUDIO IN** ports is selected or  is selected for USB TYPE B in AUDIO SOURCE of the AUDIO menu ( 52), audio sound operation in the Options window will be disabled.

USB Display(Mac computer)

The projector can display images transferred from a computer via an USB cable (📖 12).

Hardware and software requirement for computer

- **OS:** Mac OSX 10.5(Intel)
Mac OSX 10.6(Intel)
Mac OSX 10.7(Intel)
Mac OSX 10.8(Intel)

This application is not compatible with Power PC.

- **Graphic card:** 16 bit, XGA or higher
- **Memory:** 512 MB or higher
- **Hard disk space:** 30 MB or higher

Starting USB Display

When you connect your computer to the **USB TYPE B** port on the projector using a USB cable, the projector will be recognized as a CD-ROM drive on your computer. Double click the CD-ROM, then double click "LiveViewerLiteForUSB_MacOS.app."

The application, "LiveViewer Lite for USB", will close automatically when the USB cable is unplugged. However, it may remain displayed at times.



NOTE • The image transmission from the computer is suspended while the password-protected screen saver is running. To resume the transmission, exit the screen saver.

- If "Waiting for connection." remains displayed while the USB cable is connected, remove the USB cable and reconnect after a while.
- Check our web site for the latest version of the software and its manual.

(📖 **User's Manual (concise)**)

Follow the instructions that can be obtained at the site for updating.

(continued on next page)

USB Display(Mac computer) (continued)

NOTE • The “LiveViewer” (refer to the **Network Guide**) and this application cannot be used at the same time. If you connect your computer to the projector by using a USB cable while the “LiveViewer” is running, the following message will be displayed.



- Depending on the software installed on your computer, images on your computer cannot be transferred using “LiveViewer Lite for USB”.
- If any application software having the firewall function is installed into your computer, make the firewall function invalid with following the user's manual.
- Some security software may block image transmission. Please change the security software setting to allow the use of "LiveViewer Lite for USB".
- When the audio input from **USB TYPE B** is selected, if the sound level is still low even after raising the volume level in the projector to the maximum, check whether your computer outputs audio and raise the volume level accordingly.
- If the computer in use is equipped with **HDMI1** or **HDMI2/MHL** port, the audio setting will be changed and sound interruption or noise may occur when the HDMI™ cable is connected or disconnected during USB Display. Restart USB Display for this case.
- Image distortion or sound interruption may occur when “LiveViewer” is connected to **LAN** (wireless or wired) during USB Display. The above decline in performance is noticeable especially when multiple computers are connected to “LiveViewer”.

USB Display(Mac computer) (continued)

Menu

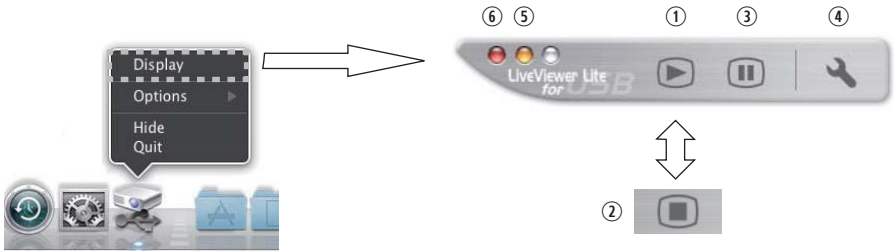

If you select “Display” on the Right-Click menu, the Floating menu shown in the right will appear on your computer screen.

- ① Start capture button
The transmission to the projector is started and the images will be displayed.
- ② Stop button
The image transmission is stopped.
- ③ Hold button
The image on the projector’s screen is temporarily frozen. The last image before the button is clicked is remained on the screen. You can revise the image data on your computer without showing it on the projector's screen.
- ④ Option button
The Options window is displayed.
- ⑤ Minimize button
The Floating menu is closed, and the icon reappears in the Windows notification area.
- ⑥ Exit button
The Floating menu is closed.

NOTE • If you click the Start capture button and/or Stop button repeatedly, images may not be displayed on the screen.

USB Display(Mac computer) (continued)

Options window

If you select the Option button on the Floating menu, the Options window is displayed.

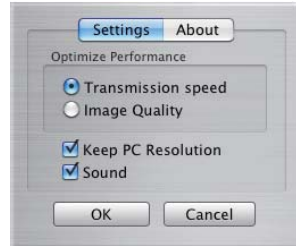

Optimize Performance

The “LiveViewer Lite for USB” captures screenshots in JPEG data and sends them to the projector. The “LiveViewer Lite for USB” has two options that have different compression rate of JPEG data.

Transmission speed

Speed takes priority over Image quality.

It makes JPEG compression rate higher.

The screen on the projector is rewritten quicker because the transferred data is smaller, but the image quality is worse.

Image quality

Image quality takes priority over Speed.

It makes JPEG compression rate lower.

The screen on the projector is rewritten slower because the transferred data is larger, but the image quality is better.

Keep PC resolution

If you remove the check mark from the [**Keep PC resolution**] box, the screen resolution of your computer will be switched as follows, and the display speed may be faster.

CP-X2542WN/CP-X3042WN/CP-X4042WN: 1024 x 768 (XGA)

CP-WX3042WN/CP-WX4042WN: 1280 x 800 (WXGA)

If your computer does not support the display resolution specified above, a smaller resolution that is the largest among the resolutions that are supported by the computer will be selected.

Sound

Turns the sound on/off. The image quality may deteriorate when you play back audio data transferred together with the image data. To give priority to the image quality, turn off the sound by selecting the checkbox.

About

The version information of the “LiveViewer Lite for USB”.

NOTE • When the resolution is changed, the arrangement of icons on computer desktop screen may be changed.

• If one of the **AUDIO IN** ports is selected or \times is selected for USB TYPE B in AUDIO SOURCE of the AUDIO menu ([52](#)), audio sound operation in the Options window will be disabled.

Maintenance

Replacing the lamp

A lamp has finite product life. Using the lamp for long periods of time could cause the pictures darker or the color tone poor. Note that each lamp has a different lifetime, and some may burst or burn out soon after you start using them.

Preparation of a new lamp and early replacement are recommended. To prepare a new lamp, make contact with your dealer and tell the lamp type number.

Type number : DT01481

Replacing the lamp

1. Turn the projector off, and unplug the power cord.
Allow the projector to cool for at least 45 minutes.
2. Prepare a new lamp. If the projector is mounted on a ceiling, or if the lamp has broken, also ask the dealer to replace the lamp.

In case of replacement by yourself, follow the following procedure.

3. Loosen the screw (marked by arrow) of the lamp cover and then slide and lift the lamp cover to the side to remove it.
4. Loosen the 2 screws (marked by arrow) of the lamp, and slowly pick up the lamp by the handle. Never loosen any other screws.
5. Insert the new lamp, and retighten firmly the 2 screws of the lamp that are loosened in the previous process to lock it in place.
6. While putting the interlocking parts of the lamp cover and the projector together, slide the lamp cover back in place. Then firmly fasten the screw of the lamp cover.
7. Turn the projector on and reset the lamp time using the LAMP TIME item in the SETUP menu.
 - (1) Press the **MENU** button to display a menu.
 - (2) Point at the **ADVANCED MENU** in the menu using the **▼/▲** button, then press the **▶** button.
 - (3) Point at the **SETUP** in the left column of the menu using the **▼/▲** button, then press the **▶** button.
 - (4) Point at the **LAMP TIME** using the **▼/▲** button, then press the **▶** button. A dialog will appear.
 - (5) Press the **▶** button to select "OK" on the dialog. It performs resetting the lamp time.

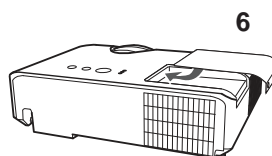
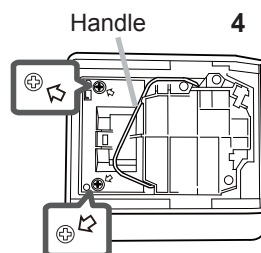
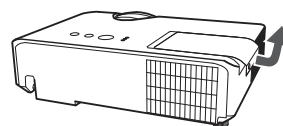
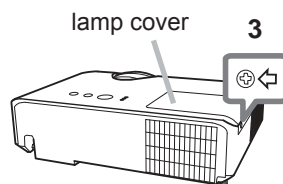

⚠ CAUTION ▶ Do not touch any inner space of the projector, while the lamp is taken out.

NOTE • Please reset the lamp time only when you have replaced the lamp, for a suitable indication about the lamp.

Replacing the lamp (continued)

Lamp warning

 **HIGH VOLTAGE**  **HIGH TEMPERATURE**  **HIGH PRESSURE**

⚠ WARNING ▶ The projector uses a high-pressure mercury glass lamp. The lamp can break with a loud bang, or burn out, if jolted or scratched, handled while hot, or worn over time. Note that each lamp has a different lifetime, and some may burst or burn out soon after you start using them. In addition, if the bulb bursts, it is possible for shards of glass to fly into the lamp housing, and for gas containing mercury and dust containing fine particles of glass to escape from the projector's vent holes.

▶ **About disposal of a lamp:** This product contains a mercury lamp; do not put it in a trash. Dispose of it in accordance with environmental laws.

- For lamp recycling, go to www.lamprecycle.org (in the US).
- For product disposal, consult your local government agency or www.eiae.org (in the US) or www.epsc.ca (in Canada).

For more information, call your dealer.



Disconnect
the plug
from the
power
outlet

- If the lamp should break (it will make a loud bang when it does), unplug the power cord from the outlet, and make sure to request a replacement lamp from your local dealer. Note that shards of glass could damage the projector's internals, or cause injury during handling, so please do not try to clean the projector or replace the lamp yourself.
- If the lamp should break (it will make a loud bang when it does), ventilate the room well, and make sure not to inhale the gas or fine particles that come out from the projector's vent holes, and not to get them into your eyes or mouth.
- Before replacing the lamp, turn the projector off and unplug the power cord, then wait at least 45 minutes for the lamp to cool sufficiently. Handling the lamp while hot can cause burns, as well as damaging the lamp.



- Never unscrew except the appointed (marked by an arrow) screws.
- Do not open the lamp cover while the projector is suspended from a ceiling. This is dangerous, since if the lamp's bulb has broken, the shards will fall out when the cover is opened. In addition, working in high places is dangerous, so ask your local dealer to have the lamp replaced even if the bulb is not broken.
- Do not use the projector with the lamp cover removed. At the lamp replacing, make sure that the screws are screwed in firmly. Loose screws could result in damage or injury.



- Use only the lamp of the specified type. Use of a lamp that does not meet the lamp specifications for this model could cause a fire, damage or shorten the life of this product.
- If the lamp breaks soon after the first time it is used, it is possible that there are electrical problems elsewhere besides the lamp. If this happens, consult your local dealer or a service representative.
- Handle with care: jolting or scratching could cause the lamp bulb to burst during use.
- Using the lamp for long periods of time, could cause it dark, not to light up or to burst. When the pictures appear dark, or when the color tone is poor, please replace the lamp as soon as possible. Do not use old (used) lamps; this is a cause of breakage.

Cleaning and replacing the air filter

Please check and clean the air filter periodically. When the indicators or a message prompts you to clean the air filter, comply with it as soon as possible. Replace the filter when it is damaged or too soiled. To prepare the new filter, make contact with your dealer and tell the following type number.

Type number : UX38841 (Filter set)

When you replace the lamp, please replace the air filter. An air filter of specified type will come together with a replacement lamp for this projector.

1. Turn the projector off, and unplug the power cord. Allow the projector to sufficiently cool down.
2. Use a vacuum cleaner on and around the filter cover.
3. Pick and pull up the filter cover knobs to take it off.
4. Use a vacuum cleaner for the filter vent of the projector.
5. Take the filter out while holding the filter cover.
6. Use a vacuum cleaner on both sides of the filter. If the filter is damaged or heavily soiled, replace it with the new one.
7. Place the filter back into the filter cover, making sure the plastic band is on the upper side.
8. Install the filter unit back into the projector.

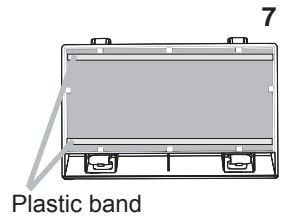
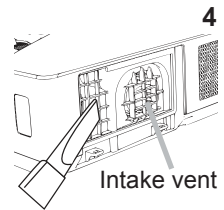
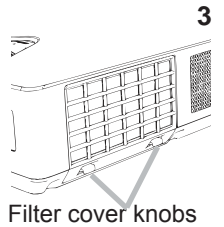
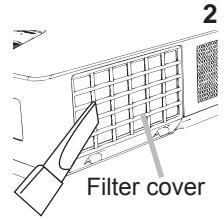

(continued on next page)

Cleaning and replacing the air filter (continued)

9. Turn the projector on and reset the filter time using the FILTER TIME item in the EASY MENU.
- (1) Press the **MENU** button to display a menu.
 - (2) Point at the FILTER TIME using the ▼/▲ button, then press the ► button. A dialog will appear.
 - (3) Press the ► button to select “OK” on the dialog. It performs resetting the filter time.

⚠ WARNING ► Before taking care of the air filter, make sure the power cable is not plugged in, then allow the projector to cool sufficiently. Taking care of the air filter in a high temperature state of the projector could cause an electric shock, a burn or malfunction to the projector.

- Use only the air filter of the specified type. Do not use the projector without the air filter or the filter cover. It could result in a fire or malfunction to the projector.
- Clean the air filter periodically. If the air filter becomes clogged by dust or the like, internal temperatures rise and could cause a fire, a burn or malfunction to the projector.

- NOTE**
- Please replace the air filter when it is damaged or heavily soiled.
 - When you replace the projection lamp, please replace the air filter. An air filter of specified type will come together with a replacement lamp for this projector.
 - Please reset the filter time only when you have cleaned or replaced the air filter, for a suitable indication about the air filter.
 - The projector may display the message such as “CHECK THE AIR FLOW” or turn off the projector, to prevent the internal heat level rising.

Other care

Inside of the projector

In order to ensure the safe use of your projector, please have it cleaned and inspected by your dealer about once every year.

Caring for the lens

If the lens is flawed, soiled or fogged, it could cause deterioration of display quality. Please take care of the lens, being cautious of handling.

1. Turn the projector off, and unplug the power cord. Allow the projector to cool sufficiently.
2. After making sure that the projector is cool adequately, lightly wipe the lens with a commercially available lens-cleaning wipe. Do not touch the lens directly with your hand.

Caring for the cabinet and remote control

Incorrect care could have adverse influence such as discoloration, peeling paint, etc.

1. Turn the projector off, and unplug the power cord. Allow the projector to cool sufficiently.
2. After making sure that the projector is cool adequately, lightly wipe with gauze or a soft cloth.
If the projector is extremely dirty, dip soft cloth in water or a neutral cleaner diluted in water, and wipe lightly after wringing well. Then, wipe lightly with a soft, dry cloth.

⚠ WARNING ▶ Before caring, make sure the power cord is not plugged in, and then allow the projector to cool sufficiently. The care in a high temperature state of the projector could cause a burn and/or malfunction to the projector.

▶ Never try to care for the inside of the projector personally. Doing is so dangerous.

▶ Avoid wetting the projector or inserting liquids in the projector. It could result in a fire, an electric shock, and/or malfunction to the projector.

- Do not put anything containing water, cleaners or chemicals near the projector.
- Do not use aerosols or sprays.

⚠ CAUTION ▶ Please take right care of the projector according to the following. Incorrect care could cause not only an injury but adverse influence such as discoloration, peeling paint, etc.

- ▶ Do not use cleaners or chemicals other than those specified in this manual.
- ▶ Do not polish or wipe with hard objects.

NOTICE ▶ Do not directly touch the lens surface with hands.

Troubleshooting





If an abnormal operation should occur, stop using the projector immediately.

⚠ WARNING ▶ Never use the projector if abnormal operations such as smoke, strange odor, excessive sound, damaged casing or elements or cables, penetration of liquids or foreign matter, etc. should occur. In such cases, immediately disconnect the power plug from the power outlet. After making sure that the smoke or odor has stopped, contact to your dealer or service company.

Otherwise if a problem occurs with the projector, the following checks and measures are recommended before requesting repair.
If this does not resolve the problem, please contact your dealer or service company. They will tell you what warranty condition is applied.

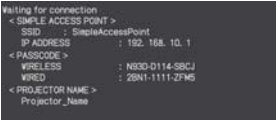

Related messages

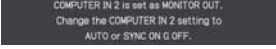
When some message appears, check and cope with it according to the following table. Although these messages will be automatically disappeared around several minutes, it will be reappeared every time the power is turned on.

Message	Description
	There is no input signal. Please confirm the signal input connection, and the status of the signal source.
	Projector is waiting for an image file. Check the hardware connection, settings on the projector and network-related settings. The computer-Projector network connection might be disconnected. Please re-connect them.
	
	The horizontal or vertical frequency of the input signal is not within the specified range. Please confirm the specs for your projector or the signal source specs.
	An improper signal is input. Please confirm the specs for your projector or the signal source specs.
	The COMPUTER IN2/MONITOR OUT port is selected as the picture input source even if MONITOR OUT is selected for COMPUTER IN2(45). Select AUTO or SYNC ON G OFF in the dialog to project the picture input to the COMPUTER IN2/MONITOR OUT port. In this case, you cannot use the MONITOR OUT function. Otherwise select other port for picture input.

(continued on next page)

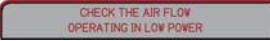
Related messages (continued)

Message	Description
	<p>The internal temperature is rising. The projector is operating in low power. Please turn the power off, and allow the projector to cool down at least 20 minutes. After having confirmed the following items, please turn the power ON again.</p> <ul style="list-style-type: none"> • Is there blockage of the air passage aperture? • Is the air filter dirty? If so, please clean or replace the air filter (📖 100, 101). • Does the peripheral temperature exceed 35°C? • If the projector is used at an altitude of about 1600 m (5250 feet) or higher, set ALTITUDE of the SERVICE item in the OPTION menu to HIGH (📖 66). <p>If the projector is used with a wrong setting, it may cause damage to the projector itself or the parts inside.</p>
	<p>A note of precaution when cleaning the air filter. Please immediately turn the power off, and clean or change the air filter referring to the Cleaning and replacing the air filter section of this manual. After you have cleaned or changed the air filter, please be sure to reset the filter timer (📖 50, 101).</p>
	<p>The button operation is not available.</p>

Regarding the indicator lamps

When operation of the **LAMP**, **TEMP** and **POWER** indicators differs from usual, check and cope with it according to the following table.

POWER indicator	LAMP indicator	TEMP indicator	Description
Lighting In Orange	Turned off	Turned off	The projector is in a standby state. Please refer to the section "Power on/off".
<i>Blinking</i> In Green	Turned off	Turned off	The projector is warming up. Please wait.
Lighting In Green	Turned off	Turned off	The projector is in an on state. Ordinary operations may be performed.
<i>Blinking</i> In Orange	Turned off	Turned off	The projector is cooling down. Please wait.
<i>Blinking</i> In Red	(discretionary)	(discretionary)	The projector is cooling down. A certain error has been detected. Please wait until POWER indicator finishes blinking, and then perform the proper measure using the item descriptions below.
<i>Blinking</i> In Red or Lighting In Red	Lighting In Red	Turned off	The lamp does not light, and there is a possibility that interior portion has become heated. Please turn the power off, and allow the projector to cool down at least 45 minutes. After the projector has sufficiently cooled down, please make confirmation of the following items, and then turn the power on again. <ul style="list-style-type: none"> • Is there blockage of the air passage aperture? • Is the air filter dirty? • Does the peripheral temperature exceed 35°C? If the same indication is displayed after the remedy, please change the lamp referring to the section Replacing the lamp .
<i>Blinking</i> In Red or Lighting In Red	<i>Blinking</i> In Red	Turned off	The lamp cover has not been properly fixed. Please turn the power off, and allow the projector to cool down at least 45 minutes. After the projector has sufficiently cooled down, please make confirmation of the attachment state of the lamp cover. After performing any needed maintenance, turn the power on again. If the same indication is displayed after the remedy, please contact your dealer or service company.

(continued on next page)

Regarding the indicator lamps (continued)

POWER indicator	LAMP indicator	TEMP indicator	Description
<p><i>Blinking In Red or Lighting In Red</i></p>	<p>Turned off</p>	<p><i>Blinking In Red</i></p>	<p>The cooling fan is not operating. Please turn the power off, and allow the projector to cool down at least 20 minutes. After the projector has sufficiently cooled down, please make confirmation that no foreign matter has become caught in the fan, etc., and then turn the power on again. If the same indication is displayed after the remedy, please contact your dealer or service company.</p>
<p><i>Blinking In Red or Lighting In Red</i></p>	<p>Turned off</p>	<p><i>Lighting In Red</i></p>	<p>There is a possibility that the interior portion has become heated. Please turn the power off, and allow the projector to cool down at least 20 minutes. After the projector has sufficiently cooled down, please make confirmation of the following items, and then turn the power on again.</p> <ul style="list-style-type: none"> • Is there blockage of the air passage aperture? • Is the air filter dirty? • Does the peripheral temperature exceed 35°C? • If the projector is used at an altitude of about 1600 m (5250 feet) or higher, set ALTITUDE of the SERVICE item in the OPTION menu to HIGH (🔧66). If the projector is used with a wrong setting, it may cause damage to the projector itself or the parts inside.
<p><i>Lighting In Green</i></p>	<p>Simultaneous <i>blinking in Red</i></p>		<p>It is time to clean the air filter. Please immediately turn the power off, and clean or change the air filter referring to the section Cleaning and replacing the air filter. After cleaning or changing the air filter, please be sure to reset the filter timer. After the remedy, reset the power to ON.</p>
<p><i>Lighting In Green</i></p>	<p>Alternative <i>blinking in Red</i></p>		<p>There is a possibility that the interior portion has become overcooled. Please use the unit within the usage temperature parameters (5°C to 35°C). After the treatment, reset the power to ON.</p>

(continued on next page)

Regarding the indicator lamps (continued)

POWER indicator	LAMP indicator	TEMP indicator	Description
Blinking In Green for approx. 3 seconds.	Turned off	Turned off	At least 1 Power ON schedule is saved to the projector. Please refer to Schedule Settings in the Network Guide.
Lighting In Orange	Lighting In Red	Lighting In Red	Loading the saved data of CLONING on STANDBY MODE.
<i>Blinking In Orange</i>	<i>Blinking In Red</i>	<i>Blinking In Red</i>	Loading the saved data of CLONING has failed on STANDBY MODE. Please refer to CLONING (📖 69 ~ 71).
Turned off	Turned off	Turned off	Loading the saved data of CLONING has succeeded on STANDBY MODE.

NOTE • When the interior portion has become overheated, for safety purposes, the projector is automatically shut down, and the indicator lamps may also be turned off. In such a case, disconnect the power cord, and wait at least 45 minutes. After the projector has sufficiently cooled down, please make confirmation of the attachment state of the lamp and lamp cover, and then turn the power on again. If the projector is used at an altitude of about 1600 m (5250 feet) or higher, set ALTITUDE of the SERVICE item in the OPTION menu to HIGH (📖 66). Otherwise, set it to NORMAL.

Resetting all settings

When it is hard to correct some wrong settings, the **FACTORY RESET** function of **SERVICE** item in **OPTION** menu (📖 72) can reset all settings (except settings such as **AUTO BLANK**, **STANDBY MODE**, **LANGUAGE**, **LAMP TIME**, **FILTER TIME**, **FILTER MESSAGE**, **SECURITY** and **NETWORK**) to the factory default. Be sure to set **ALTITUDE** after resetting all the settings (📖 66).

Phenomena that may be easy to be mistaken for machine defects

About the phenomenon confused with a machine defect, check and cope with it according to the following table.

Phenomenon	Cases not involving a machine defect	Reference page
Power does not come on.	The electrical power cord is not plugged in. Correctly connect the power cord.	16
	The main power source has been interrupted during operation such as by a power outage (blackout), etc. Please disconnect the power plug from the power outlet, and allow the projector to cool down at least 10 minutes, then turn the power on again.	16
	Either there is no lamp and/or lamp cover, or either of these has not been properly fixed. Please turn the power off and disconnect the power plug from the power outlet, and allow the projector to cool down at least 45 minutes. After the projector has sufficiently cooled down, please make confirmation of the attachment state of the lamp and lamp cover, and then turn the power on again.	98
Neither sounds nor pictures are outputted.	The signal cables are not correctly connected. Correctly connect the connection cables.	12 ~ 15
	Signal source does not correctly work. Correctly set up the signal source device by referring to the manual of the source device.	–
	The input changeover settings are mismatched. Select the input signal, and correct the settings.	24, 25
	The BLANK function for pictures and the MUTE function for sounds are working. AV MUTE may be active. Refer to the item “Sound does not come out” and “No pictures are displayed” on the next page to turn off the MUTE and BLANK functions.	23, 31

(continued on next page)

Phenomena that may be easy to be mistaken for machine defects (continued)

Phenomenon	Cases not involving a machine defect	Reference page
Sound does not come out.	<p>The signal cables are not correctly connected. Correctly connect the audio cables.</p>	12 ~ 15
	<p>The MUTE function is working. Restore the sound pressing MUTE or VOLUME +/- button on the remote control.</p>	23
	<p>The volume is adjusted to an extremely low level. Adjust the volume to a higher level using the menu function or the remote control.</p>	23, 52
	<p>The AUDIO SOURCE/SPEAKER setting is not correct. Correctly set the AUDIO SOURCE/SPEAKER in AUDIO menu.</p>	52
	<p>The Sound button (J) or checkbox is disabled. If you have selected USB TYPE A, turn the sound on from the Thumbnail menu. If you have selected USB TYPE B, put a check mark on the Sound checkbox in the Options window of “LiveViewer Lite for USB”. If you have selected LAN, put a check mark on the Sound checkbox in the Option menu of “LiveViewer”.</p>	83, 93, 97
No pictures are displayed.	<p>The lens cover is attached. Remove the lens cover.</p>	4
	<p>The signal cables are not correctly connected. Correctly connect the connection cables.</p>	12 ~ 15
	<p>The brightness is adjusted to an extremely low level. Adjust BRIGHTNESS to a higher level using the menu function.</p>	36
	<p>The computer cannot detect the projector as a Plug-and-Play monitor. Make sure that the computer can detect a Plug-and-Play monitor using another Plug-and-Play monitor.</p>	11
	<p>The BLANK screen is displayed. Press BLANK button on the remote control.</p>	31
	<p>COMPUTER IN2 is set to MONITOR OUT. Set COMPUTER IN2 to AUTO or SYNC ON G OFF.</p>	45

(continued on next page)

Phenomena that may be easy to be mistaken for machine defects (continued)

Phenomenon	Cases not involving a machine defect	Reference page
No pictures are displayed. (continued)	<p>"Waiting for connection." remains displayed even though the USB TYPE B port is selected. Remove the USB cable and reconnect after a while.</p>	13
	<p>The projector does not recognize the USB storage device inserted into USB TYPE A port. Before removing the USB storage device, be sure to use the REMOVE USB function on the thumbnail screen, which appears when the USB TYPE A port is selected as the input source.</p>	13, 83
Video screen display freezes.	<p>The FREEZE function is working. Press FREEZE button to restore the screen to normal.</p>	31
Colors have a faded- out appearance, or Color tone is poor.	<p>Color settings are not correctly adjusted. Perform picture adjustments by changing the COLOR TEMP, COLOR, TINT and/or COLOR SPACE settings, using the menu functions.</p>	38, 43
	<p>COLOR SPACE setting is not suitable. Change the COLOR SPACE setting to AUTO, RGB, SMPTE240, REC709 or REC601.</p>	43
Pictures appear dark.	<p>The brightness and/or contrast are adjusted to an extremely low level. Adjust BRIGHTNESS and/or CONTRAST settings to a higher level using the menu function.</p>	36
	<p>The projector is operating in Eco mode. Set ECO MODE to OFF, and set AUTO ECO MODE to OFF, in the SETUP menu.</p>	49
	<p>The lamp is approaching the end of its product lifetime. Replace the lamp.</p>	98, 99
Pictures appear blurry.	<p>Either the focus and/or horizontal phase settings are not properly adjusted. Adjust the focus using the focus ring, and/or H PHASE using the menu function.</p>	27, 42
	<p>The lens is dirty or misty. Clean the lens referring to the section Caring for the lens.</p>	102

(continued on next page)

Phenomena that may be easy to be mistaken for machine defects (continued)

Phenomenon	Cases not involving a machine defect	Reference page
Some kind of image degradation such as flickering or stripes appear on screen.	<p>When the projector is operating in Eco mode, flickering may appear on screen. Set ECO MODE to OFF, and set AUTO ECO MODE to OFF, in the SETUP menu.</p>	49
	<p>The OVER SCAN ratio is too big. Adjust OVER SCAN in the IMAGE menu smaller.</p>	41
	<p>Excessive VIDEO NR. Change the setting of VIDEO NR in the INPUT menu.</p>	43
	<p>The FRAME LOCK function cannot work on the current input signal. Set FRAME LOCK in the INPUT menu to OFF.</p>	45
The sound or image is unstable or is output intermittently.	<p>When LAN, USB TYPE A or USB TYPE B port is selected, some ports of the output may be missing due to signal processing delay. Change the signal or use another port.</p>	24, 52
The computer connected to the USB TYPE B port of the projector does not start up.	<p>The computer cannot start up in the current hardware configuration. Disconnect the USB cable from the computer, then reconnect it after starting up the computer.</p>	13
RS-232C does not work.	<p>The SAVING function is working. Select NORMAL for STANDBY MODE item in the SETUP menu.</p>	51
	<p>The COMMUNICATION TYPE for the CONTROL port is set to NETWORK BRIDGE. Select OFF for COMMUNICATION TYPE item in the OPTION - SERVICE - COMMUNICATION menu.</p>	68
NETWORK BRIDGE function does not work	<p>The NETWORK BRIDGE function is turned off. Select NETWORK BRIDGE for COMMUNICATION TYPE item in the OPTION - SERVICE - COMMUNICATION menu.</p>	68
Network does not work	<p>The SAVING function is working. Select NORMAL for STANDBY MODE item in the SETUP menu.</p>	51
	<p>The same network address is set for both wireless and wired LAN. Change the network address setting for wireless or wired LAN.</p>	-

(continued on next page)

Phenomena that may be easy to be mistaken for machine defects (continued)

Phenomenon	Cases not involving a machine defect	Reference page
<p>Schedule function does not work</p>	<p>The SAVING function is working. Select NORMAL for STANDBY MODE item in the SETUP menu.</p>	51
	<p>The internal clock has been reset. Once you turn off the projector in the SAVING mode or the AC power, the current date and time setting is reset. Check the DATE AND TIME setting for WIRELESS SETUP or WIRED SETUP in the NETWORK menu.</p>	-
<p>When the projector is connected to wired LAN, it powers off and on as described below.</p> <p>Powers off ←</p> <p>↓</p> <p>POWER indicator blinks in orange a few times</p> <p>↓</p> <p>Goes into standby mode</p>	<p>Disconnect the LAN cable and check that the projector is working properly. If this phenomenon occurs after connecting to the network, there may be a loop between two Ethernet switching hubs within the network,</p> <ul style="list-style-type: none"> - There are two or more Ethernet switching hubs in a network. - Two of the hubs are doubly connected by LAN cables. - This double connection forms a loop between the two hubs. <p>Such a loop may have an adverse effect on the projector as well as the other network devices. Check the network connection and remove the loop by disconnecting the LAN cables such that there is only one connecting cable between two hubs.</p>	-
<p>Unable to save the CLONING data.</p>	<p>USB memory is out of memory. Please delete unnecessary files to free up memory. At least 1MB of memory is needed. USB memory is write-protected. Unlock the USB memory.</p>	
<p>Unable to load the CLONING saved data.</p>	<p>Unable to find the saved data from USB memory. Execute SAVE then LOAD by going through the procedure. File name of USB memory doesn't match. Please assign "pj_data.bin" for setting data, and for MyScreen "pj_logo.bmp" or "pj_logo.gif". STANDBY mode is set to SAVING. Switch the SAVING to NORMAL in STANDBY MODE under SET UP menu beforehand to load the CLONING data using control panel on the projector while the lamp is in standby state.</p>	69 ~ 71

NOTE • Although bright spots or dark spots may appear on the screen, this is a unique characteristic of liquid crystal displays, and it does not constitute or imply a machine defect.

Specifications

Please see the **Specifications** in the **User's Manual (concise)** which is a book.

End User License Agreement for the Projector Software

- Software in the projector consists of the plural number of independent software modules and there exist our copyright or/and third party copyrights for each of such software modules.
- Be sure to read “End User License Agreement for the Projector Software” which is separated document.