

## Key Features:

- ▶ Dual JBL low frequency drivers with a 64 mm (2½ in) diameter edgewound ribbon voice coil which provides more cross-sectional wire area in the voice coil gap than round wire designs, for greater efficiency and power handling.
- ▶ Ferro-fluid cooled compression driver with titanium diaphragm improves high frequency performance as well as system reliability.
- ▶ The advanced network topology crossover design shapes frequency response and delivers coherent summation in the crossover region.
- ▶ A “Quasi 3-Way” design offers the extra bass for which a dual fifteen system is designed, but without sacrificing performance in the critical mid-range. The upper woofer produces mid-frequencies and bass, while the lower woofer concentrates on bass only. The reduction in mid-range phase cancellation greatly improves mid-range sound quality and coverage.
- ▶ High-voltage capacitors and inductors with massive cores and heavy gauge wire enable the crossover network to handle high power without saturating.
- ▶ Progressive Transition™ high-frequency waveguide provides superior coverage control, reduced distortion, and smoother frequency response.
- ▶ The rugged, acoustically superior enclosure is constructed from 19 mm (¾ in) MDF (Medium Density Fiberboard) using advanced adhesives and mechanical fastener technology for extreme durability and improved low-frequency performance.
- ▶ SonicGuard™ protects the high-frequency driver from excess power without interrupting the performance.
- ▶ Non-resonant, all-steel handles are used.
- ▶ Attractive 18-gauge perforated, steel grille protects components from damage.



The JRX125 is a portable, dual fifteen-inch, two-way speaker system designed specifically for applications in live music performance and music playback. The dual fifteen configuration is especially useful for applications in which additional low-frequency power and extension is needed but adding a subwoofer to the system is not practical.

## Specifications:

System Type:	Dual 15" 2-way, sound reinforcement speaker
Frequency Range (-10 dB): <sup>2</sup>	35 Hz - 16 kHz
Frequency Response (±3 dB): <sup>2</sup>	45 Hz - 12 kHz
Sensitivity (1w/1m):	100 dB SPL
Nominal Impedance:	4 Ω
Power Capacity: <sup>1</sup>	500 watts
Peak Power Capacity: <sup>1</sup>	2000 watts
Recommended Amplifier Power:	500-1000 watts @ 4 Ω
Maximum SPL:	133 dB
Nominal Dispersion:	90° x 50°
Crossover Frequency:	2 kHz
Dimensions (H x W x D): <sup>3</sup>	1092 mm x 464 mm x 426 mm (43 in x 18.3 in x 16.8 in)
Weight:	42.6 kg (94 lb)
Shipping Weight:	46.7 kg (103 lb)
High Frequency Driver:	JBL 2412, 1" exit compression driver mounted on Progressive Transition™ Waveguide
Low Frequency Driver:	JBL M115-8A x 2
Input Connectors:	Neutrik® Speakon® NL-4 (x1); ¼" TS phone jack (x1); parallel
Enclosure Construction:	19 mm (¾ in) MDF (Medium Density Fiberboard); with glued and mechanically fastened joint detail; covered in black carpet.
Grille:	18-gauge, powder-coated steel
Mounting & Suspension:	None

<sup>1</sup> "Power Capacity" and "Peak Power Capacity" ratings are based on the average and peak power capacity of product samples subjected to a 100 hour power test using random noise with a 6 dB crest factor, in accordance with IEC standards.

<sup>2</sup> "Frequency Range" and "Frequency Response" are based on half-space conditions.

<sup>3</sup> Height dimension includes feet.

JBL continually engages in research related to product improvement. Some materials, production methods and design refinements are introduced into existing products without notice as a routine expression of that philosophy. For this reason, any current JBL product may differ in some respect from its published description, but will always equal or exceed the original design specifications unless otherwise stated.

# ► JRX125 Dual 15 Inch Two-Way Speaker

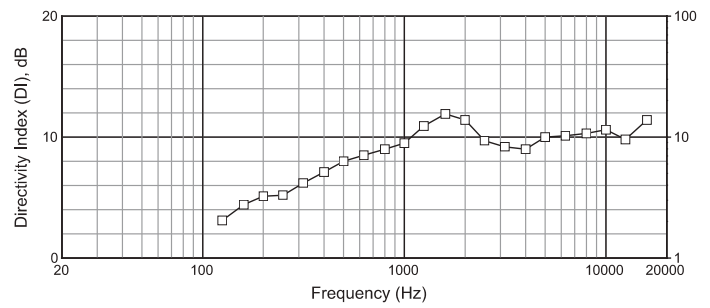
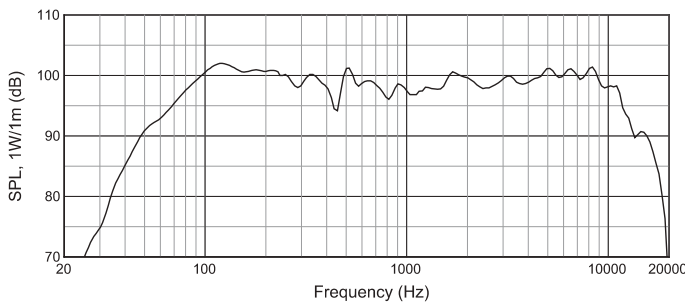
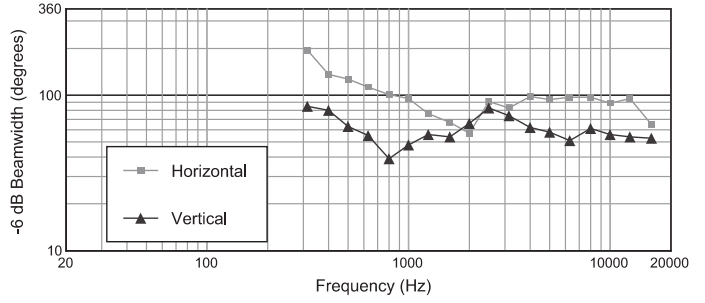
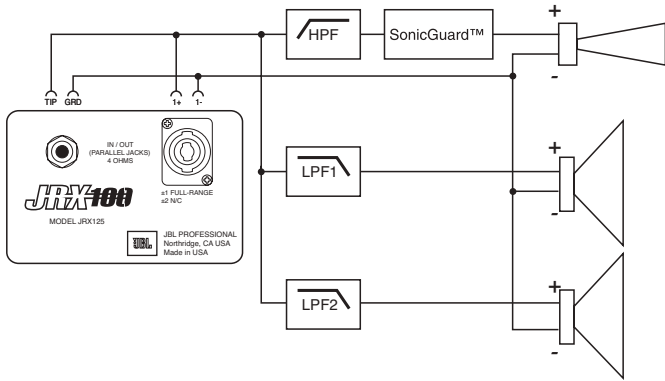

## Dimensions

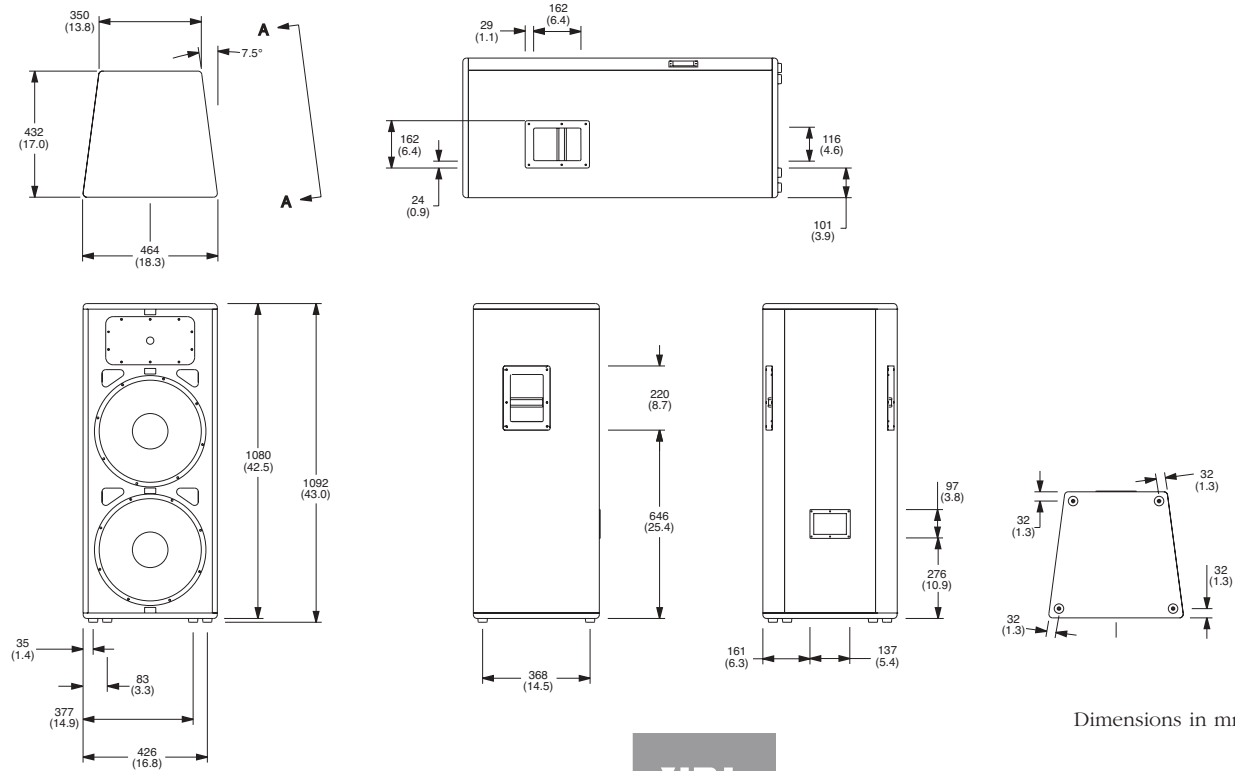

Dimensions in mm (in)



JBL Professional  
8500 Balboa Boulevard, P.O. Box 2200  
Northridge, California 91329 U.S.A.

© A Harman International Company  
© Copyright 2007 JBL Professional

SSJRX125  
352931-001  
CRP 5M  
04/08