



# MRX528S

## Dual 18" High Power Subwoofer

### Key Features:

- ▶ Dual 18 inch, 2044H drivers for extended low-frequency output
- ▶ Large vents for reduced distortion
- ▶ Vertical orientation for convenient ground stacking
- ▶ Tough DuraFlex™ enclosure finish

### Applications:

- ▶ Live performance venues
- ▶ Mobile and fixed DJ systems

The MRX528S is a compact, high power subwoofer system containing dual 2044H 457 mm (18") woofer in a front-loaded, vented enclosure. The enclosure is designed to present a minimum frontal area. It is also configured in an upright format to permit the convenient stacking of full-range enclosures on top without the need for an additional pole.

The system offers complete input connection flexibility for compatibility with a variety of cabling schemes. The input panel incorporates a pair of Neutrik® Speakon® NL-4 connectors wired in parallel. The MRX528S is supplied with pins +1/-1 connected to the woofer. This may be easily reconfigured to work with cabling systems intended to drive subwoofers on pins +2/-2.

The enclosure is constructed of quality plywood, coated in JBL's rugged DuraFlex™ finish and is braced to maximize low-frequency performance. The attractive CNC-machined, 16-gauge steel grille is internally lined with an acoustically transparent screen to provide additional driver protection and give a very professional appearance.



### Specifications:

Frequency Range (-10 dB):	35 Hz – 250 Hz
Frequency Response (±3 dB):	40 Hz – 250 Hz
Input Connection Modes:	Internally configurable, +1/-1 or +2/-2
Recommended Crossover:	80 - 120 Hz, 24 - 48 dB/octave
Power Rating: (Continuous/Program/Peak)	1000 W/ 2000 W/ 4000 W, 2 hrs <sup>1</sup> 800 W/ 1600 W/ 3200 W, 100 hrs <sup>1</sup>
Maximum SPL:	133 dB SPL continuous (139 dB SPL peak) <sup>2</sup>
System Sensitivity (1w @ 1m):	97 dB SPL; 103 dB SPL <sup>2</sup>
LF Driver:	2 x JBL 2044H 457 mm (18 in) woofers
Nominal Impedance:	4 ohms
Enclosure:	Rectangular, 18mm, birch plywood
Finish:	Black DuraFlex™ finish
Grille:	Powder coated, black, 16 gauge perforated steel with acoustically transparent black screen backing.
Input Connectors:	Neutrik® Speakon® NL-4 (x2)
Dimensions (H x W x D):	1095 mm x 535 mm x 700 mm (43 in x 21 in x 27.5 in)
Net Weight:	55 kg (121 lb)

<sup>1</sup> 40 Hz to 400 Hz pink noise with 6 dB crest factor for specified period  
<sup>2</sup> Calculated on half space condition

JBL continually engages in research related to product improvement. Some materials, production methods and design refinements are introduced into existing products without notice as a routine expression of that philosophy. For this reason, any current JBL product may differ in some respect from its published description, but will always equal or exceed the original design specifications unless otherwise stated.

# ► MRX528S Dual 18" High Power Subwoofer

## Frequency Response:

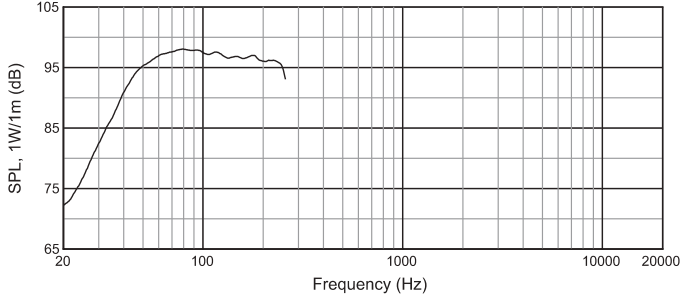

## Block Diagram:

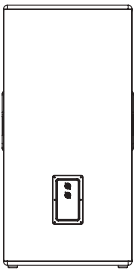
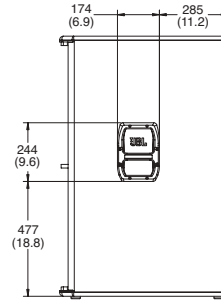
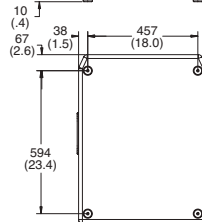
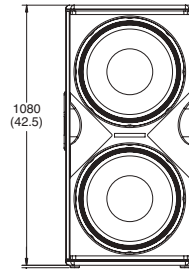
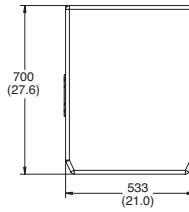
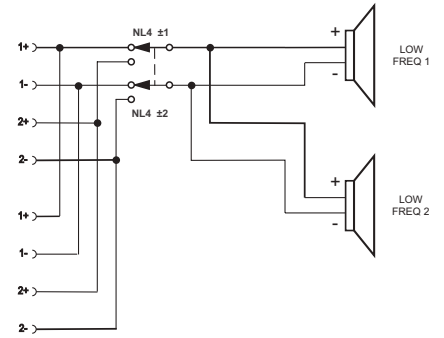
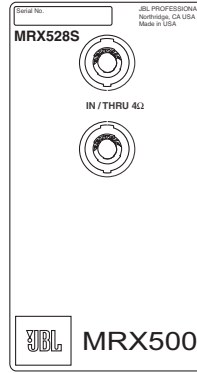

Dimensions in mm (in)



JBL Professional  
 8500 Balboa Boulevard, P.O. Box 2200  
 Northridge, California 91329 U.S.A.

■ A Harman International Company  
 © Copyright 2006 JBL Professional

SS MRX528S  
 CRP 5M  
 03/06