



SRX722/SRX722F Dual 12" High-Power Two-Way Speaker

Professional Series

Key Features:

- ▶ Light-weight, compact and very high-power
- ▶ Dual 305 mm (12 in) Differential Drive® low-frequency drivers for very high acoustic output
- ▶ 102 mm (4 in) voice-coil neodymium compression driver for high-power capacity and very light-weight
- ▶ 75° x 50° coverage
- ▶ Bi-amplified or full-range passive operation
- ▶ Flying version available (SRX722F) with five suspension points may be used with optional M10 eyebolts or detachable track fittings

Applications

- ▶ Reinforcement of speech and vocal music
- ▶ High-output mid / high system for dance music or live sound reinforcement

Designed primarily for use in subwoofer-equipped systems, the SRX722 delivers very high acoustic output from a compact, easily transported system. The SRX722 contains two 305 mm (12 in) 2262H patented* Differential Drive® woofers with combined power handling of 1200 watts (continuous). For the high frequencies, a 2451H 102 mm (4 in) voice-coil, neodymium compression driver is mounted to a 75° by 50° aluminum horn. The 75° coverage angle of the SRX722 is wide enough to provide coverage of an audience when used one-per-side yet narrow enough to allow splaying of multiple enclosures without excessive coverage overlap.

Bi-amp or full-range passive operation may be selected by means of a recessed, high-current switch mounted on the input plate.

For applications requiring suspension, a flying version, the SRX722F is available. The F version offers the option of selecting economical, forged eyebolts (not included) for fixed installation or the convenience of detachable track fittings (not included) for portable applications.

*U.S. Patent 5,748,760; other U.S. and foreign patents pending.

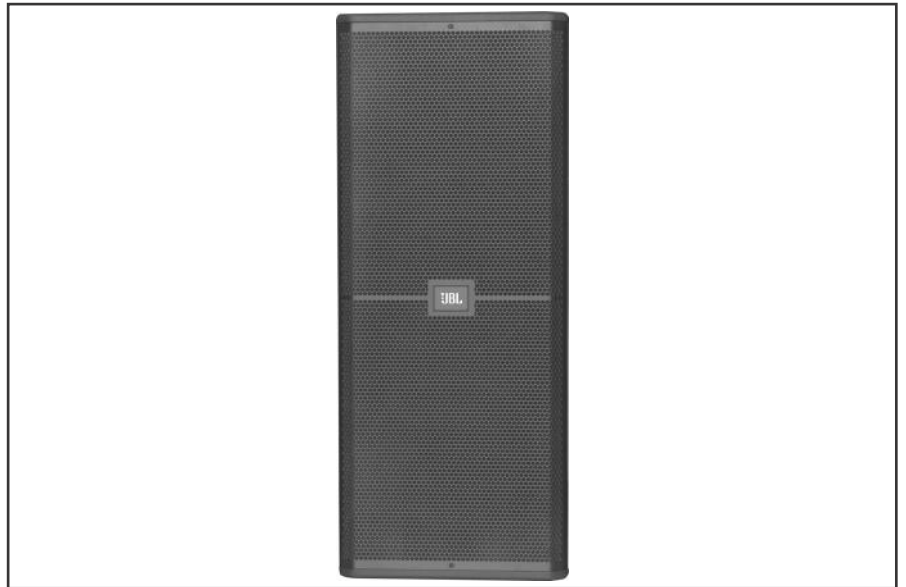

The enclosure is constructed of top quality birch plywood and coated in JBL's rugged DuraFlex™ finish. The attractive CNC-machined, 16-gauge steel grille wraps around the sides of the enclosure so there are no protruding lips on the front of the box to create acoustical interference. The grilles are internally lined with acoustically transparent foam to provide additional driver protection and give a very professional appearance.

Specifications:

| | |
|--|---|
| System Type: | Dual 12", two-way, bass-reflex |
| Frequency Range (-10 dB): | 72 Hz – 20 kHz |
| Frequency Response (±3 dB): | 81 Hz – 20 kHz |
| Coverage Pattern: | 75° x 50° nominal |
| Crossover Modes: | Bi-amp / passive, externally switchable |
| Crossover Frequency: | 1.2 kHz |
| Power Rating (Continuous ¹ / Program / Peak): | Passive: 1200 W / 2400 W / 4800 W Bi-amp LF: 1200 W / 2400 W / 4800 W Bi-amp HF: 75 W / 150 W / 300 W |
| Maximum SPL: | 135 dB SPL peak |
| System Sensitivity (1w @ 1m): | 97 dB SPL (passive mode) |
| LF Driver: | 2 x JBL 2262H 305 mm (12 in) Differential Drive woofer |
| HF Driver: | 1 x JBL 2451H 102 mm (4 in) voice-coil, neodymium compression driver |
| Nominal Impedance: | Passive: 4 ohms Bi-amp LF: 4 ohms Bi-amp HF: 8 ohms |
| Active Tunings: | dbx DriveRack, all models. Settings available at www.jblpro.com |
| Enclosure: | Trapezoidal, 15 mm, 11-ply birch plywood |
| Suspension / Mounting: | 5 x suspension points, M10 or fly track (SRX722F only) |
| Transport: | 2 x steel handles |
| Finish: | Black DuraFlex finish |
| Grille: | Powder coated, black, 16-gauge perforated steel with transparent charcoal foam backing. Removable JBL badge and punched JBL logo. |
| Input Connectors: | Neutrik® Speakon® NL-4 (x2) |
| Dimensions (H x W x D): | 965 mm x 394 mm x 394 mm (38.0 in x 15.5 in x 15.5 in) |
| Net Weight: | 34 kg (76 lb) |
| Optional Accessories: | SRX722-CVR: Pull-over padded cover SRX-FF3: 3x detachable flying fitting 229-00017-00: 10 mm forged eyebolt kit |

¹IEC filtered with 6 dB crest factor.

²Calculated based on power rating and sensitivity.

JBL continually engages in research related to product improvement. Some materials, production methods and design refinements are introduced into existing products without notice as a routine expression of that philosophy. For this reason, any current JBL product may differ in some respect from its published description, but will always equal or exceed the original design specifications unless otherwise stated.

SRX722/SRX722F Dual 12" High-Power, Two-Way Speaker

Block Diagram

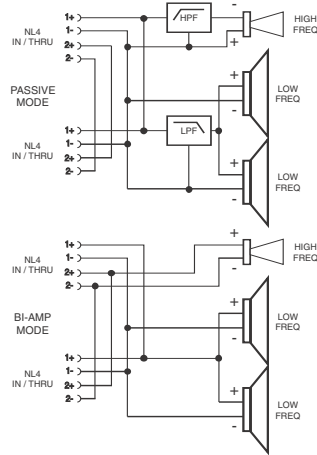
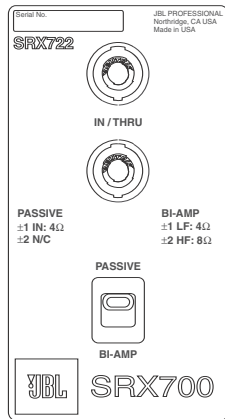

Frequency Response

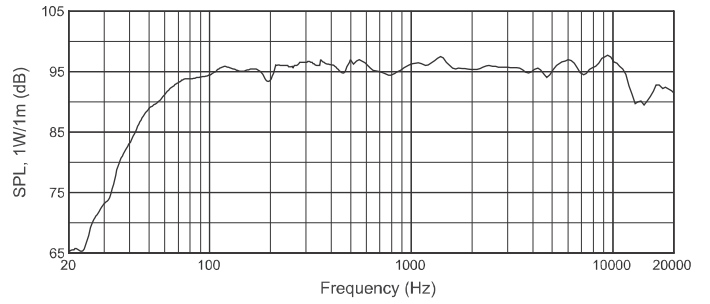

Beamwidth

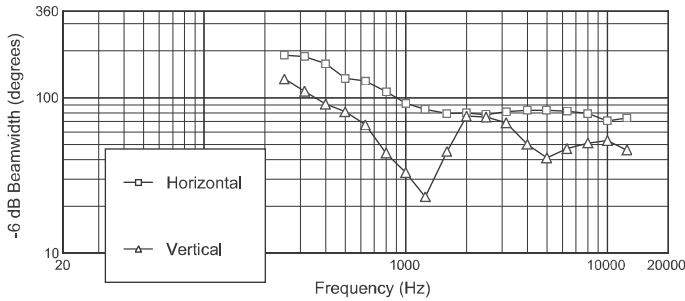

Directivity Index

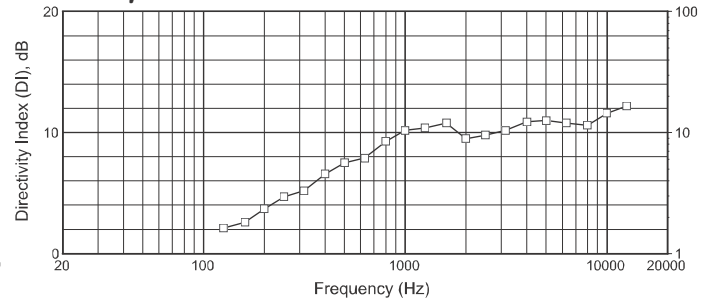

Graphs represent performance with passive crossover network

Dimensions

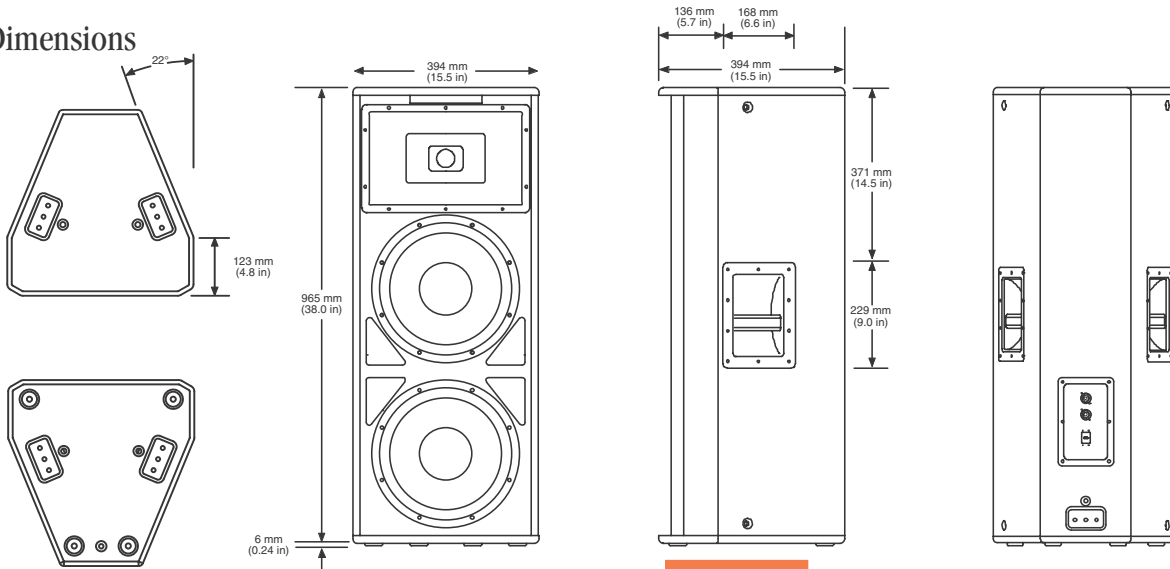

(SRX722F shown)

JBL Professional
 8500 Balboa Boulevard, P.O. Box 2200
 Northridge, California 91329 U.S.A.
 A Harman International Company
 © Copyright 2004 JBL Professional

SS SRX722
 CRP 5M
 08/04