

# LED Bar™

## USER MANUAL



# TABLE OF CONTENTS

LED Bar™ .....	1
<b>1. BEFORE YOU BEGIN .....</b>	<b>3</b>
WHAT IS INCLUDED .....	3
UNPACKING INSTRUCTIONS .....	3
AC POWER .....	3
CONTACT US .....	3
SAFETY INSTRUCTIONS .....	4
<b>2. INTRODUCTION .....</b>	<b>5</b>
FEATURES .....	5
DMX CHANNEL SUMMARY .....	5
PRODUCT OVERVIEW .....	6
<b>3. SETUP .....</b>	<b>7</b>
FUSE REPLACEMENT .....	7
FIXTURE LINKING .....	7
Data Cabling .....	7
DMX Data Cable .....	8
Cable Connectors .....	8
3-Pin to 5-Pin Conversion Chart .....	8
SETTING UP A DMX SERIAL DATA LINK .....	9
MASTER/SLAVE FIXTURE LINKING .....	9
MOUNTING .....	9
Orientation .....	9
Rigging .....	9
<b>4. OPERATING INSTRUCTIONS .....</b>	<b>10</b>
USING THE CONTROL PANEL .....	10
Control Panel Modes & Functions .....	10
MASTER/SLAVE & STAND ALONE .....	11
MASTER/SLAVE & STAND ALONE .....	11
Built in programs detailed .....	11
DMX CONTROL MODE .....	12
Daisy Chain Connection .....	12
DMX mode setup .....	12
About DMX addressing .....	13
CONTROLLING MULTIPLE LED Bars™ AS ONE DEVICE .....	13
DMX CHANNEL VALUES .....	14
GENERAL TROUBLESHOOTING .....	15
TECHNICAL SUPPORT .....	16
<b>5. APPENDIX .....</b>	<b>16</b>
DMX PRIMER .....	16
GENERAL MAINTENANCE .....	17
RETURNS PROCEDURE .....	17
CLAIMS .....	17
TECHNICAL SPECIFICATIONS .....	18

# 1. BEFORE YOU BEGIN

## What is included

- 1 x LED Bar™
- 2 Tall Mounting Brackets
- 2 Short Mounting Brackets
- Power Cord
- Warranty Card
- User Manual

## Unpacking Instructions

Immediately upon receiving a fixture, carefully unpack the carton, check the contents to ensure that all parts are present, and have been received in good condition. Notify the shipper immediately and retain packing material for inspection if any parts appear damaged from shipping or the carton itself shows signs of mishandling. Save the carton and all packing materials. In the event that a fixture must be returned to the factory, it is important that the fixture be returned in the original factory box and packing.

## AC Power

This fixture has an auto-switching power supply that can accommodate a wide range of input voltages. The only thing necessary to do before powering on the unit is to make sure the line voltage you are applying is within the range of accepted voltages. This fixture will accommodate between 100V and 240V AC. All fixtures must be powered directly off a switched circuit and cannot be run off a rheostat (variable resistor) or dimmer circuit, even if the rheostat or dimmer channel is used solely for a 0% to 100% switch.

To determine the power requirements for a particular fixture, see the label affixed to the back plate of the fixture or refer to the fixture's specifications chart. A fixture's listed current rating is its average current draw under normal conditions. All fixtures must be powered directly off a switched circuit and cannot be run off a rheostat (variable resistor) or dimmer circuit, even if the rheostat or dimmer channel is used solely for a 0% to 100% switch. Before applying power to a fixture, check that the source voltage matches the fixture's requirement. Check the fixture or device carefully to make sure that if a voltage selection switch exists that it is set to the correct line voltage you will use.

Figure 1 - AC Voltage Switch

### Warning!

**Verify that the voltage select switch on your unit matches the line voltage applied. Damage to your fixture may result if the line voltage applied does not match the voltage indicated on the voltage selector switch. All fixtures must be connected to circuits with a suitable Earth Ground.**



Not all fixtures have a voltage select switch. Please be sure to connect to the proper voltage.

## Contact Us

### General Information

### Technical Support

LSW Service Department  
81 Gould St. Campsie  
NSW 2194

### World Wide Web

[www.industrygear.com](http://www.industrygear.com)

## Safety Instructions



Please read these instructions carefully, as it includes important information about the installation, usage and maintenance of this product.

- Please keep this User Guide for future consultation. If you sell the unit to another user, be sure that they also receive this instruction booklet.
- Always make sure that you are connecting to the proper voltage, and that the line voltage you are connecting to is not higher than that stated on the decal or rear panel of the fixture.
- This product is intended for indoor use only!
- To prevent risk of fire or shock, do not expose fixture to rain or moisture. Make sure there are no flammable materials close to the unit while operating.
- The unit must be installed in a location with adequate ventilation, at least 20in (50cm) from adjacent surfaces. Be sure that no ventilation slots are blocked.
- Always disconnect from power source before servicing or replacing lamp or fuse and be sure to replace with same lamp source.
- Secure fixture to fastening device using a safety chain. Never carry the fixture solely by its head. Use its carrying handles.
- Maximum ambient temperature (Ta) is 95°F (35°C). Do not operate fixture at temperatures higher than this.
- In the event of a serious operating problem, stop using the unit immediately. Never try to repair the unit by yourself. Repairs carried out by unskilled people can lead to damage or malfunction. Please contact the nearest authorized technical assistance center. Always use the same type spare parts.
- Don't connect the device to a dimmer pack.
- Make sure the power cord is never crimped or damaged.
- Never disconnect the power cord by pulling or tugging on the cord.
- Avoid direct eye exposure to the light source while it is on.

### **Caution!**

***There are no user serviceable parts inside the unit. Do not open the housing or attempt any repairs yourself. In the unlikely event your unit may require service, please contact LSW at: 97875905***

# 2. INTRODUCTION

## Features

- 4-channel DMX-512 LED cyclorama light
- Blackout/static/dimmer/strobe
- Operating modes:
  - Blackout and static / flashing colors
  - RGB color mixing
  - Color fade
- Static colors and RGB color mixing with or without DMX controller
- Built-in automated programs via master/slave or DMX
- Built-in sound active programs via master/slave or DMX

## Additional Features

- Linkable with COLORbank™ LED
- Additional power output for daisy chaining units together
- Master/slave mode with additional output for daisy chaining
  - Allows for color-changing runway effect (up to 31 units)
- Sound sensitivity knob
- Low power consumption

## Optional Controller

- LED Bar™ Foot Controller (LED-FS1)

## DMX Channel Summary

Blackout and Static/Flashing colors		Chase Programs		RGB Mode		Color Fade Mode	
CH	DESCRIPTION	CH	DESCRIPTION	CH	DESCRIPTION	CH	DESCRIPTION
<b>1</b>	DMX: (000~079) Static Colors	<b>1</b>	DMX: (080~209) Programs 1 ~ 13	<b>1</b>	DMX: (210~219) RGB Color Mix	<b>1</b>	DMX: (220~255) Color Fade and Auto Run
<b>2</b>	No Function	<b>2</b>	Run Speed	<b>2</b>	Red	<b>2</b>	Run/Fade Speed
<b>3</b>	Flash Speed	<b>3</b>	Flash Speed	<b>3</b>	Green	<b>3</b>	No Function
<b>4</b>	No Function			<b>4</b>	Blue	<b>4</b>	No Function

For a detailed view of DMX values turn to the DMX Channel Values on page 16 in the Appendix section.

# Product Overview

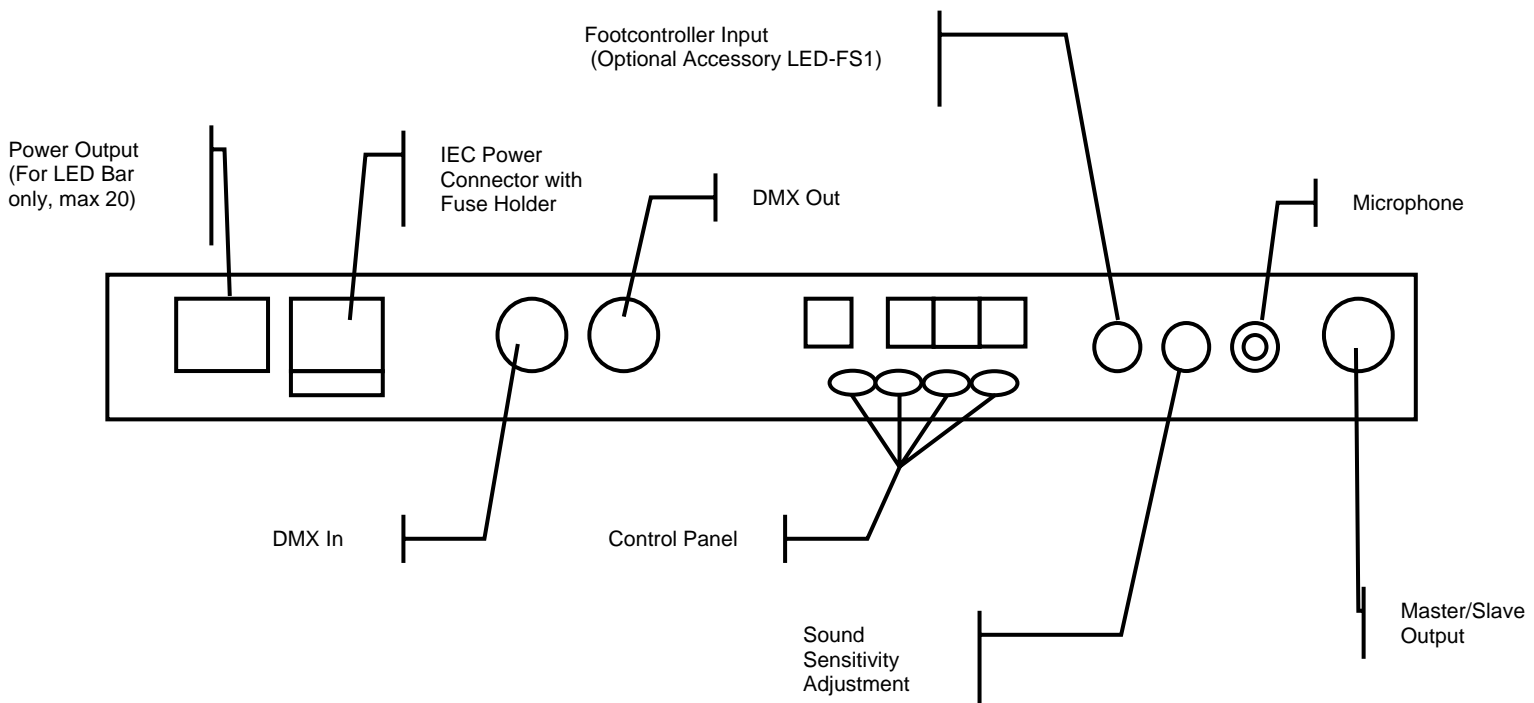
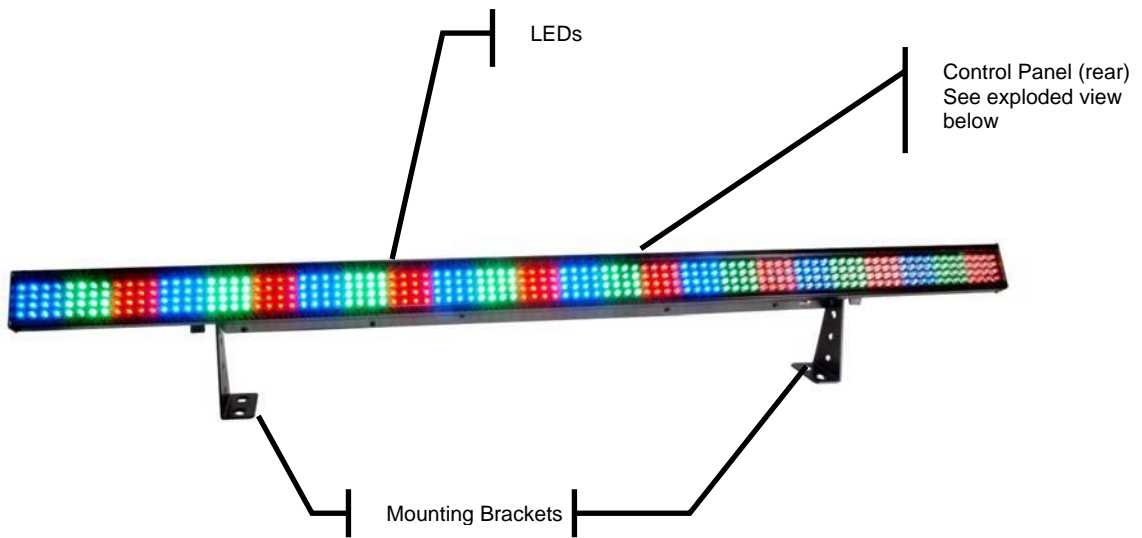

# 3. SETUP



Disconnect the power cord before replacing a fuse and always replace with the same type fuse.



## Fuse Replacement

With a flat head screwdriver wedge the fuse holder out of its housing. Remove the damaged fuse from its holder and replace with exact same type fuse. Insert the fuse holder back in its place and reconnect power.

The fuse is located inside this compartment. Remove using a flat head screwdriver.



## Fixture Linking

You will need a serial data link to run light shows of one or more fixtures using a DMX-512 controller or to run synchronized shows on two or more fixtures set to a master/slave operating mode. The combined number of channels required by all the fixtures on a serial data link determines the number of fixtures the data link can support.

**Important:** Fixtures on a serial data link must be daisy chained in one single line. To comply with the EIA-485 standard no more than 32 devices should be connected on one data link. Connecting more than 32 fixtures on one serial data link without the use of a DMX optically-isolated splitter may result in deterioration of the digital DMX signal.

Maximum recommended serial data link distance: 500 meters (1640 ft.)

Maximum recommended number of fixtures on a serial data link: 32 fixtures

## Data Cabling

To link fixtures together you must obtain data cables. You can purchase Light Emotion-certified DMX cables directly from a dealer/distributor or construct your own cable. If you choose to create your own cable please use data-grade cables that can carry a high quality signal and are less prone to electromagnetic interference.

## DMX DATA CABLE

Use a Belden© 9841 or equivalent cable which meets the specifications for EIA RS-485 applications. Standard microphone cables cannot transmit DMX data reliably over long distances. The cable will have the following characteristics:

*2-conductor twisted pair plus a shield*  
*Maximum capacitance between conductors – 30 pF/ft.*  
*Maximum capacitance between conductor and shield – 55 pF/ft.*  
*Maximum resistance of 20 ohms / 1000 ft.*  
*Nominal impedance 100 – 140 ohms*

## CABLE CONNECTORS

Cabling must have a male XLR connector on one end and a female XLR connector on the other end.

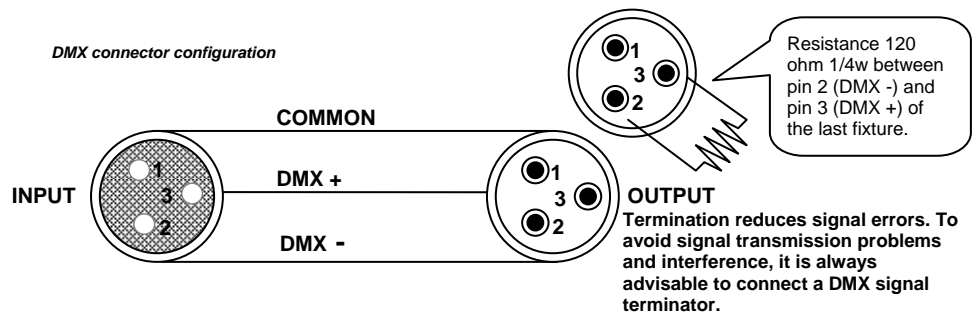

**CAUTION** Do not allow contact between the common and the fixture's chassis ground. Grounding the common can cause a ground loop, and your fixture may perform erratically. Test cables with an ohm meter to verify correct polarity and to make sure the pins are not grounded or shorted to the shield or each other.

## 3-PIN TO 5-PIN CONVERSION CHART

**Note!** If you use a controller with a 5 pin DMX output connector, you will need to use a 5 pin to 3 pin adapter. Light Emotion Model No: DMX5M, or DMX5F. The chart below details a proper cable conversion:

3 PIN TO 5 PIN CONVERSION CHART		
Conductor	3 Pin Female (output)	5 Pin Male (Input)
Ground/Shield	Pin 1	Pin 1
Data ( - ) signal	Pin 2	Pin 2
Data ( + ) signal	Pin 3	Pin 3
Do not use		Do not use
Do not use		Do not use



## Setting up a DMX Serial Data Link

1. Connect the (male) 3 pin connector side of the DMX cable to the output (female) 3 pin connector of the controller.
2. Connect the end of the cable coming from the controller which will have a (female) 3 pin connector to the input connector of the next fixture consisting of a (male) 3 pin connector.
3. Then, proceed to connect from the output as stated above to the input of the following fixture and so on.

### CHAUVET Certified DMX Data Cables

Order Code	Description
DMX1.5	DMX Cable 1.5m/4.9ft
DMX4.5	DMX Cable 4.5m/14.8ft
DMX10	DMX Cable 10m/32.8ft

### Universal DMX Controller

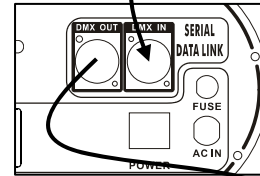
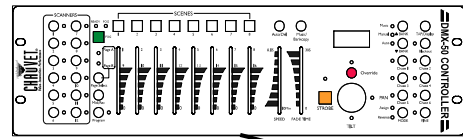

This drawing provides a general illustration of the DMX Input/Output panel of a lighting fixture.

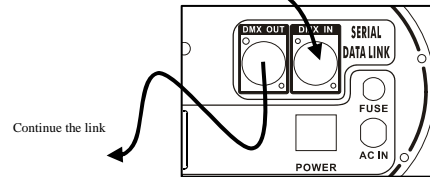

Continue the link

## Master/Slave Fixture Linking

1. Connect the (male) 3 pin connector side of the DMX cable to the output (female) 3 pin connector of the first fixture.
2. Connect the end of the cable coming from the first fixture which will have a (female) 3 pin connector to the input connector of the next fixture consisting of a (male) 3 pin connector. Then, proceed to connect from the output as stated above to the input of the following fixture and so on.

Often, the setup for Master-Slave and Standalone operation requires that the first fixture in the chain be initialized for this purpose via either settings in the control panel or DIP-switches. Secondly, the fixtures that follow may also require a slave setting. Please consult the "Operating Instructions" section in this manual for complete instructions for this type of setup and configuration.

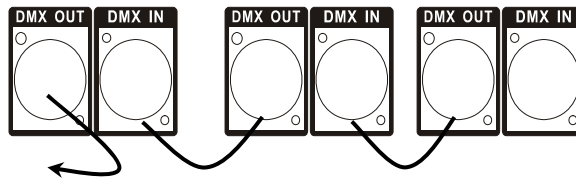

## Mounting

### ORIENTATION

This fixture may be mounted in any position provided there is adequate room for ventilation.

### RIGGING

It is important never to obstruct the fan or vents pathway. Mount the fixture using a suitable "C" or "O" type clamp. Adjust the angle of the fixture by loosening both knobs and tilting the fixture. After finding the desired position, retighten both knobs.

- When selecting installation location, take into consideration lamp replacement access and routine maintenance.
- Safety cables must always be used.
- Never mount in places where the fixture will be exposed to rain, high humidity, extreme temperature changes or restricted ventilation.

### Hanging Clamp

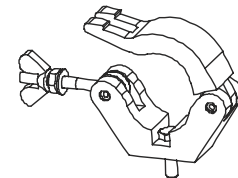

Note!  
Clamp is sold separately.

# 4. OPERATING INSTRUCTIONS

The LED Bar™ is a DMX-512 controllable, full RGB color mixing LED strip light fixture made up of highly efficient and super bright LEDs. There are four flood spot led surfaces whose intensity can be controlled together allowing the creation of an unlimited range of colors.

The LED Bar™ can operate in Stand-Alone, Master/Slave and via DMX-512 control utilizing 4 channels of control.

## Using the control panel

1. Press the [MODE] button repeatedly until the display reads the mode function you wish to change.
2. Press the [DOWN] or [UP] buttons to toggle or scroll through values that pertain to that function.
3. Press [ENTER] to enter the sub-menus.

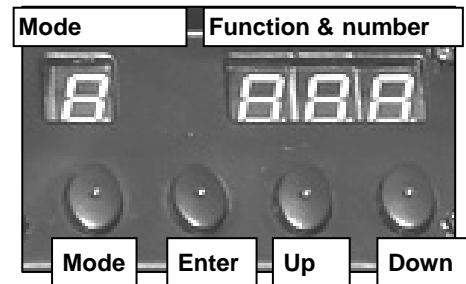

## Control Panel Modes & Functions

MODE	FUNC	PROGRAM	FUNCTION/PROGRAM	( P ) RUN SPEED	( F ) FLASH SPEED	( C ) COLOR		
Ct	000	000	Blackout					
		001	Red		000 – 100			
		002	Green		000 - 100			
		003	Blue		000 - 100			
		004	Yellow		000 - 100			
		005	Purple		000 - 100			
		006	Cyan		000 - 100			
		007	White		000 - 100			
		008	Color Change 1	Automatic 000 - 050		000 - 100		
		009	Color Change 2			000 - 100		
		010	Color Change 3			000 - 100		
		011	Color Change 4			000 - 100		
		012	Color Change 5					
		013	Color Change 6					
		014	Sequential Color Chase 1		Sound Active 051 - 100			
		015	Sequential Color Chase 2					
		016	Sequential Color Chase 3					
		017	Sequential Color Chase 4					
		018	Sequential Color Chase 5					
		019	Sequential Color Chase 6					
		020	Sequential Color Chase 7					
		021	RGB		Red (000-100)	Green (000-100)	Blue (000-100)	
		022	Color Fade		000-100			
023	Automatic Program (Sound)							
SYS	S dAd		DMX Channel Addressing					
	S Aad		Re-initialize fixture Re-establishes correct number of down-link fixtures for sequential color chase runs.					

## Master/Slave & Stand Alone

The Master/Slave mode will allow you to link units in a daisy chain fashion. In this mode, the first unit in the daisy chain will command all other units following. Stand Alone can simply be achieved by setting all units to Master. They would no longer be required to be linked in series.

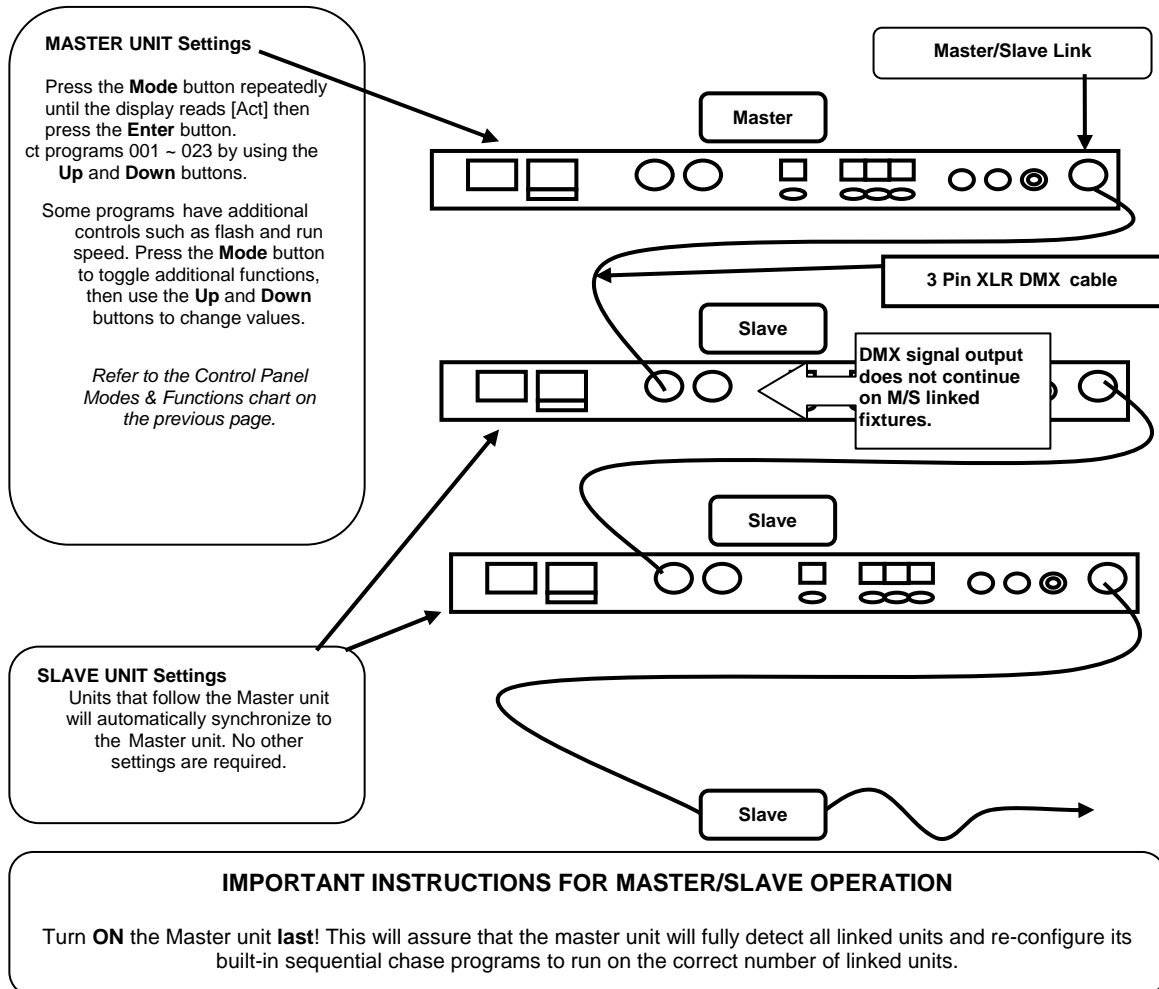

## Built in programs detailed

PROGRAM	FUNCTION	OPTIONS
000	Blackout	
001-007	Solid flashing colors	<b>F</b> = Flash speed
008-013	Color chase programs	<b>P</b> = Run speed <b>F</b> = Flash speed
014-020	Sequential color chase patterns	Use sound sensitivity rotary knob to adjust sound level for optimum response or decrease sensitivity completely to operate in Run speed only <b>P</b> = Run speed
021	RGB (manual color mix)	<b>P</b> = Red <b>F</b> = Green <b>C</b> = Blue
022	Color fade	<b>P</b> = Run speed

## DMX Control Mode

Operating in a DMX Control mode environment gives the user the greatest flexibility when it comes to customizing or creating a show. In this mode you will be able to control each individual trait of the fixture and each fixture independently.

### DAISY CHAIN CONNECTION

1. Connect the (male) 3 pin connector side of the DMX cable to the output (female) 3 pin connector of the first fixture.
2. Connect the end of the cable coming from the first fixture which will have a (female) 3 pin connector to the input connector of the next fixture consisting of a (male) 3 pin connector. Then, proceed to connect from the output, as stated above, to the input of the following fixture and so on.

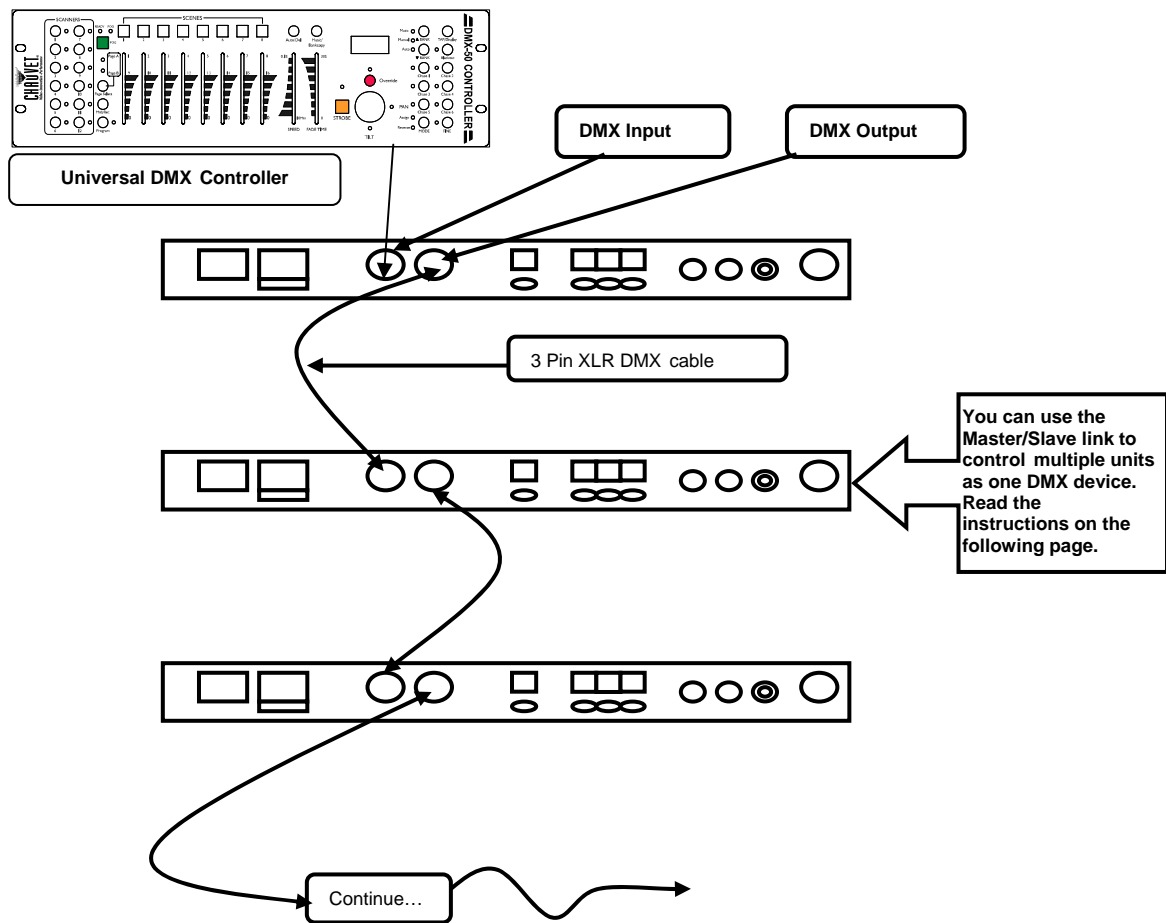

### DMX MODE SETUP

1. Press the **Mode** button until the display reads [SyS] then press **Enter**.
2. Press the **Up** and **Down** buttons until the display reads [S dAd] then press **Enter**.
3. Set the DMX address value by using the **Up** and **Down** buttons.
4. Press the **Mode** button; use the **Up/Down** until the display reads [S Aad]. Press **Enter** to make changes permanent.
5. Press the **Up/Down** buttons to return to the DMX control state, the display will read [S dAd].
6. Repeat this for every fixture you wish to address.

## About DMX addressing

This DMX mode enables the use of a universal DMX controller device. Each fixture requires a "start address" from 1 to 511. A fixture requiring one or more channels for control begins to read the data on the channel indicated by the start address. For example, a fixture that occupies, or uses, 6 channels of DMX and was addressed to start on DMX channel 100 would read data from channels: 100, 101, 102, 103, 104, and 105. Choose starting addresses so that the channels used do not overlap, and notate the start address selected for future reference.

If this is your first time addressing a fixture using the DMX-512 control protocol than we suggest jumping to the Appendix Section and read the heading "DMX Primer". It contains very useful information that will help you understand its use.

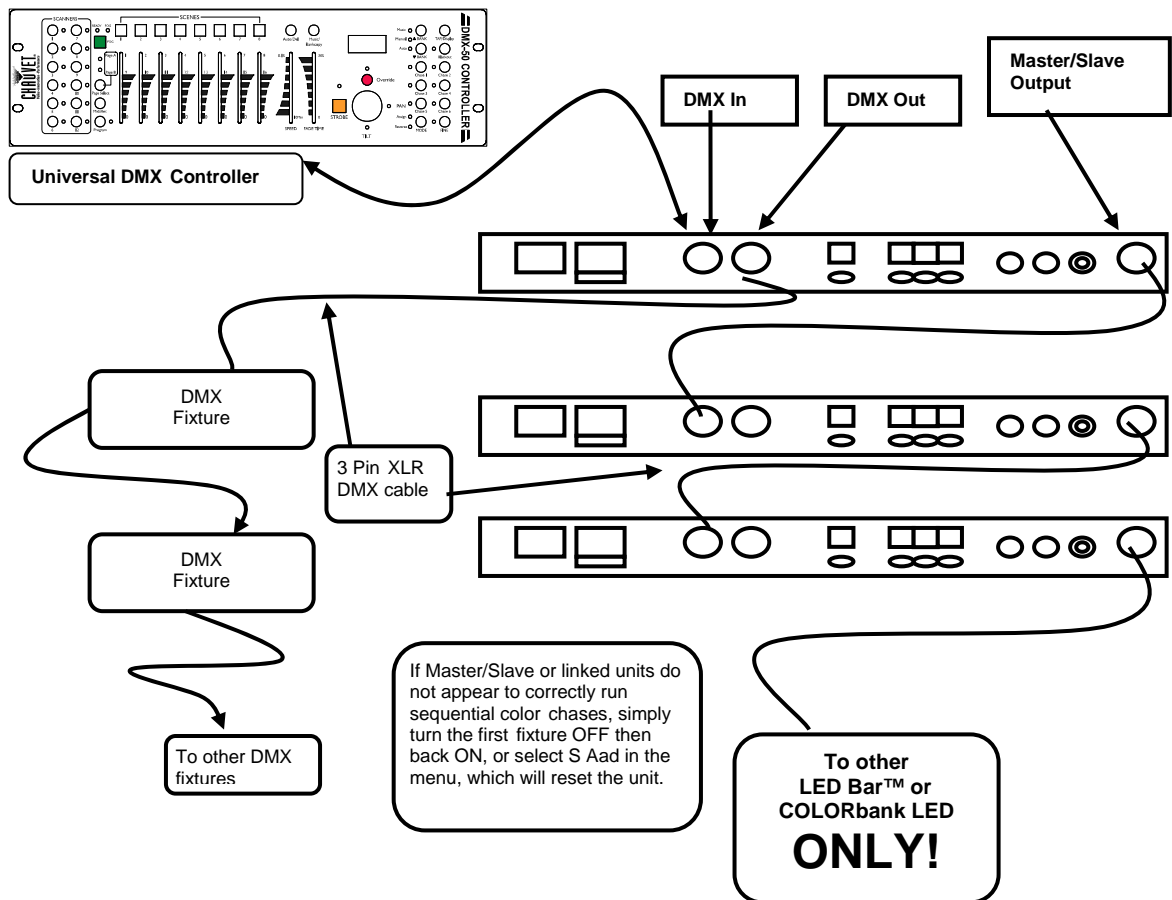

## Controlling multiple LED Bars™ as one device

1. Turn on all Fixtures
2. On the first fixture, press the Mode button until the display reads [SyS] then press Enter.
3. Press the **Up** and **Down** buttons until the display reads [S dAd] then press **Enter**.
4. Set the DMX address value by using the **Up** and **Down** buttons.
5. Press the **Mode** button, use the **Up/Down** until the display reads [S Aad]. Press **Enter** to make changes permanent and re-initialize the fixture so that all following fixtures in the down-link can be counted and the sequential color chases will run correctly.
6. Press the **Up/Down** buttons to return to the DMX control state, the display will read [S dAd].

## DMX Channel Values

**NOTE!**

Please read all instructions carefully on fixture DMX control mode and addressing.

DMX channels 2, 3 and 4 functions are determined by the current settings of channel 1. For example, while Channel 1 is set between 210 and 219 the following conditions will apply;

- Channel 2 will control the Red LEDs
- Channel 3 will control the Green LEDs
- Channel 4 will control the Blue LEDs

CHANNEL	VALUE	FUNCTION	CH 2	CH 3	CH 4
1	000 ⇔ 009	Static Colors		Flash Speed 000 ⇔ 249 Sound Active 250 ⇔ 255	
	010 ⇔ 019	Blackout			
	020 ⇔ 029	Red			
	030 ⇔ 039	Green			
	040 ⇔ 049	Blue			
	050 ⇔ 059	Yellow			
	060 ⇔ 069	Purple			
	070 ⇔ 079	Cyan			
		White			
	080 ⇔ 089	Color Changes			
090 ⇔ 099	Color change 1				
100 ⇔ 109	Color change 2				
110 ⇔ 119	Color change 3				
120 ⇔ 129	Color change 4				
130 ⇔ 139	Color change 5				
	Color change 6				
140 ⇔ 149	Sequential Color Chases				
150 ⇔ 159	Color chase 1				
160 ⇔ 169	Color chase 2				
170 ⇔ 179	Color chase 3				
180 ⇔ 189	Color chase 4				
190 ⇔ 199	Color chase 5				
200 ⇔ 209	Color chase 6				
	Color chase 7				
210 ⇔ 219	RGB Color Mix	Red	Green	Blue	
	RGB mode	0-100%	0-100%	0-100%	
220 ⇔ 229	Color Fade	Fade Speed 0-100%			
230 ⇔ 255	Auto Run (sound active only)				

## General Troubleshooting

Symptom	Solution(s)	Applies to			
		Lights	Foggers & Snow	Controllers	Dimmers & Chaser
Auto shut off	Check fan thermal switch reset	✓			
Beam is very dim or not bright	Clean optical system or replace lamp Check 220/110v switch for proper setting	✓			
Breaker/Fuse keeps blowing	Check total load placed on device				✓
Chase is too slow	Check users manual for speed adjustment	✓		✓	✓
Device has no power	Check for power on Mains. Check device's fuse. (internal and/or external)	✓		✓	✓
Fixture is not responding	Check DMX Dip switch settings for correct addressing Check DMX cables Check polarity switch settings	✓			
Fixture is on but there is no movement to the audio	Make sure you have the correct audio mode on the control switches. If audio provided via ¼" jack, make sure a live audio signal exists Adjust sound sensitivity knob	✓		✓	✓
Lamps cuts off sporadically	Possible bad lamp or fixture is overheating. Lamp may be at end of its life.	✓			
Light will not come on after power failure	Some discharge lamps require a cooling off period before the electronics in the fixture can kick start it again, wait 5 to 10 minutes before powering up	✓			
Loss of signal	Use only DMX cables Install terminator Note: Keep DMX cables separated from power cables or black lights.	✓	✓	✓	✓
No flash	Re-install bulb, may have shifted in shipping	✓			
No laser output	Bounce mirror motor may have shifted during shipping, readjust	✓			
Relay will not work	Check reset switch Check cable connections				✓
Remote does not work	Make sure connector is firmly connected to device	✓	✓		
Stand alone mode	All Light Emotion lighting fixtures featuring stand-alone functions do not require additional settings, simply power the fixture and it will automatically enter into this mode	✓			

**If you still have a problem after trying the above solutions, please contact LSW Technical Support at the location on the next page.**

## Technical Support

Address: Service Dept.  
Support (Email):  
Telephone: (02) 97875905  
Fax:  
Website: <http://www.industrygear.com>

# 5. APPENDIX

## DMX Primer

There are 512 channels in a DMX-512 connection. Channels may be assigned in any manner. A fixture capable of receiving DMX 512 will require one or a number of sequential channels. The user must assign a starting address on the fixture that indicates the first channel reserved in the controller. There are many different types of DMX controllable fixtures and they all may vary in the total number of channels required. Choosing a start address should be planned in advance. Channels should never overlap. If they do, this will result in erratic operation of the fixtures whose starting address is set incorrectly. You can however, control multiple fixtures of the same type using the same starting address as long as the intended result is that of unison movement or operation. In other words, the fixtures will be slaved together and all respond exactly the same.

DMX fixtures are designed to receive data through a serial Daisy Chain. A Daisy Chain connection is where the DATA OUT of one fixture connects to the DATA IN of the next fixture. The order in which the fixtures are connected is not important and has no effect on how a controller communicates to each fixture. Use an order that provides for the easiest and most direct cabling. Connect fixtures using shielded two conductor twisted pair cable with three pin XLR male to female connectors. The shield connection is pin 1, while pin 2 is Data Negative (S-) and pin 3 is Data positive (S+). CHAUVET carries 3-pin XLR DMX compliant cables, DMX-10 (33'), DMX-4.5 (15') and DMX-1.5 (5')



## General Maintenance

To maintain optimum performance and minimize wear fixtures should be cleaned frequently. Usage and environment are contributing factors in determining frequency. As a general rule, fixtures should be cleaned at least twice a month. Dust build up reduces light output performance and can cause overheating. This can lead to reduced lamp life and increased mechanical wear. Be sure to power off fixture before conducting maintenance.

Unplug fixture from power. Use a vacuum or air compressor and a soft brush to remove dust collected on external vents and internal components. Clean all glass when the fixture is cold with a mild solution of glass cleaner or Isopropyl Alcohol and a soft lint free cotton cloth or lens tissue. Apply solution to the cloth or tissue and drag dirt and grime to the outside of the lens. Gently polish optical surfaces until they are free of haze and lint.

The cleaning of internal and external optical lenses and/or mirrors must be carried out periodically to optimize light output. Cleaning frequency depends on the environment in which the fixture operates: damp, smoky or particularly dirty surrounding can cause greater accumulation of dirt on the unit's optics. Clean with soft cloth using normal glass cleaning fluid. - Always dry the parts carefully. - Clean the external optics at least every 20 days. Clean the internal optics at least every 30/60 days.

## Returns Procedure

Returned merchandise must be sent prepaid and in the original packing, call tags will not be issued. Package must be clearly labeled with a Return Merchandise Authorization Number (RA #). Products returned without an RA # will be refused. Call LSW and request RA # prior to shipping the fixture. Be prepared to provide the model number, serial number and a brief description of the cause for the return. Be sure to properly pack fixture, any shipping damage resulting from inadequate packaging is the customer's responsibility. LSW reserves the right to use its own discretion to repair or replace product(s). As a suggestion, proper UPS packing or double-boxing is always a safe method to use.

**Note:** If you are given an RA #, please include the following information on a piece of paper inside the box:

- 1) Your name
- 2) Your address
- 3) Your phone number
- 4) The RA #
- 5) A brief description of the symptoms

## Claims

Damage incurred in shipping is the responsibility of the shipper; therefore the damage must be reported to the carrier upon receipt of merchandise. It is the customer's responsibility to notify and submit claims with the shipper in the event that a fixture is damaged due to shipping. Any other claim for items such as missing component/part, damage not related to shipping, and concealed damage, must be made within seven (7) days of receiving merchandise.

## Technical Specifications

### WEIGHT & DIMENSIONS

Length..... 38 in (965 mm)  
 Width .....2.5 in (64 mm)  
 Height .....6 in (152 mm)  
 Weight ..... 4.5 lbs (9.1 kgs)

### POWER

Auto-switching power supply..... 100-240V 50/60Hz  
 Power Consumption ..... 33.3W (.39A) max at 120V  
 Inrush Power ..... 24.6W (.33A) at 120V  
 Power Factor ..... .70 at 120V  
 Power Output (AC Plug)..... 8A (960W at 120V) max

### LIGHT SOURCE

LED.....384 Total (128 red, 128 green, 128 blue) 100,000 hour

### PHOTO OPTIC

Beam Angle ..... 63° x 29°  
 Field Angle..... 82° x 52°

### THERMAL

Maximum ambient temperature..... 104°F (40°C)

### FUSE

Main..... 1.5A 250V fast blow

### CONTROL & PROGRAMMING

Data input ..... locking 3-pin XLR male socket  
 Data output ..... locking 3-pin XLR female socket  
 Data pin configuration ..... pin 1 shield, pin 2 (-), pin 3 (+)  
 Protocols..... DMX-512 USITT  
 DMX Channels .....4

### ORDERING INFORMATION

LED Bar™ .....LED Bar

### WARRANTY INFORMATION

Warranty ..... 2-year limited warranty

## Snapshot

<b>OK on Dimmer</b>	
<b>Outdoor OK</b>	
<b>Sound Activated</b>	
<b>DMX512</b>	
<b>Master/Slave</b>	
<b>115V/230V Switch</b>	
<b>Replaceable Fuse</b>	
<b>User Serviceable</b>	
<b>Duty Cycle</b>	