

# StageSource L3t

The World's Most Versatile Loudspeaker System for Musicians



Technical Specifications



## StageSource L3t Technical Specifications

StageSource L3t combines multi-function design, powerful DSP and precision components to deliver the perfect blend of high-powered performance and true scalability. With Smart Speaker modes, an integrated mixer and digital networking, StageSource L3t delivers best-of-class performance across the widest variety of live sound applications.

- 1,400-watt, 3-way, tri-amped speaker system
- Smart Speaker Modes for great live sound in any live sound situation
- Multi-channel mixer with 3-band EQ, Smart Effects, and acoustic guitar modeling
- Multi-band feedback suppression
- On-board accelerometer and pole-mount sensors
- Virtual Tilt-back projects speaker's output upwards in backline mode
- L6 LINK™ digital networking for multi-speaker setups
- Multi-function design for true scalability
- Dual-braced tour-grade plywood enclosure with M10 suspension points
- Retractable handles for easy portability

### Acoustical

System Type:	Dual 10", 3-way, tri-amplified loudspeaker system
Frequency Range (-10 dB):	40 Hz to 19 kHz, (Reference/P.A. Speaker Mode, free-field)
Frequency Response ( $\pm 3$ dB):	47 Hz to 18 kHz, (Reference/P.A. Speaker Mode, free-field)
Maximum SPL Output:	132 dB peak @ 1 meter (unweighted, measured indoors with music program material)
Coverage Pattern (-6 dB):	100° horizontal x 50° vertical
Directivity Factor (Q):	8.7 (averaged 1 kHz to 16 kHz)
Directivity Index (DI):	9.4 dB (averaged 1 kHz to 16 kHz)
Crossover Frequencies:	LF1 Low-pass - 250 Hz LF2 to HF Crossover - variable, 2.2 kHz to 7.0 kHz (Speaker Mode dependent)
Low Frequency Transducers:	2 x 10" extended range woofer, 2" diameter voice coil, 4 $\Omega$ impedance
High Frequency Transducer:	1" exit compression driver, 1.4" diameter voice coil and diaphragm, 8 $\Omega$ impedance

### Electrical – Side Panel

Input Type:	2x mic/instrument XLR-1/4", balanced
Input Impedance (each input):	2.63 k $\Omega$ balanced (Pad = 0 dB), 23.7 k $\Omega$ balanced (Pad = 20 dB)
Gain Range (each input):	-infinity to +57 dB (Pad = 0 dB); -infinity to +37 dB (Pad = 20 dB)
Max Input Level:	+25 dBu (Gain at minimum 'on' position, 20 dB pad on)
Controls:	2x Gain, 20 dB Pad, LF Level, MF Freq & Level, HF Level, Mod Level, Reverb Level, Feedback Suppression On/Off/Mode 1x Dual Mono/Stereo Link Mode, Acoustic Modeling Amount, On/Off
Indicators:	2x Signal Present/Clip, 2x Feedback Suppression On/Off/Mode, 1x Acoustic Modeling On/Off

# StageSource L3t

The World's Most Versatile Loudspeaker System for Musicians



Technical Specifications

## Electrical – Rear Panel

Input Types:	Line-level XLR-1/4", balanced	Stereo RCA, unbalanced	L6 LINK™ XLR
Input Impedance:	100 kΩ balanced	20 kΩ balanced	N/A
Max Input Levels:	+20 dBu	+16 Dbv	N/A
Onset of Limiting:	+7 dBu input (Reference/P.A. Speaker Mode, Master Level control at center-detent) -5 dBu input (Reference/P.A. Speaker Mode, Master Level control at maximum)		
Output Types:	Balanced Loop Thru XLR	Balanced Mix Out XLR	L6 LINK XLR
Output Impedances:	Source-dependent	680 Ω balanced	N/A
Controls:	Feedback Suppression On/Off/Mode, Master Level, Speaker Mode		
Indicators:	Signal Present/Clip, Feedback Suppression On/Off/Mode, Limit, 6x Speaker Mode, L6 LINK Status		

## Digital Signal Processing

Speaker Modes:	Reference/P.A., Playback, Floor Monitor, Keyboards, Acoustic Guitar, Electric Guitar
On-board Effects:	Reverb, Modulation, Feedback Suppression, Acoustic Modeling
Transducer Protection:	Excursion limiting, thermal limiting
Digital Networking:	L6 LINK Intelligent Speaker Networking System
Sensors:	Speaker orientation, pole sensor, power amp temperature, power supply, temperature

## Power Amplification and Supply

Output Channel:	LF1	LF2	HF
Power Amplifier Type:	Class D	Class D	Class AB
Peak Output Power <sup>1</sup> :	655 Watts	655 Watts	175 Watts
Power Supply Voltage Range:	100 - 240 VAC, ± 10%, 50/60 Hz , automatic voltage selection		
Power Consumption:	250 watts (1/8th power)		
Cooling:	Digitally-controlled, variable speed 50 mm fan		
Protection:	Output overcurrent, overtemperature, DC fault		

## Mechanical

Enclosure:	15 mm enclosure, 18 mm baffle, multi-ply hardwood, textured black paint, bass reflex design
Floor Monitor Upward Angle:	60° using kickstands, 30° using handle
Suspension Points:	M10 x 1.5 threaded inserts, qty: 4
Pullback Point:	M10 x 1.5 threaded insert, qty: 1
Grille:	18 gauge perforated steel, black powder coat finish
Pole Cup:	35 mm pole cup with sensor
Dimensions (HxWxD):	33.875" (861 mm) x 12.25" (312 mm) x 12.25" (312 mm)
Weight:	57.5 lb (26.1 kg)

## Accessory Part Numbers

Speaker Bag:	98-037-0001
Short Pole:	98-037-0003
Long Pole:	98-037-0004
Eyebolt Suspension Kit:	98-037-0005

<sup>1</sup> 1kHz sine wave input, 1% THD+N unweighted into the nominal load impedance, single channel driven, before the onset of limiting.

# StageSource L3t

The World's Most Versatile Loudspeaker System for Musicians



Technical Specifications

## Mixer Control Panel

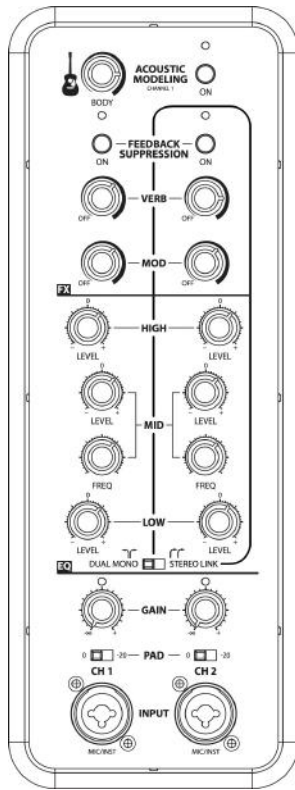

## System Control Panel

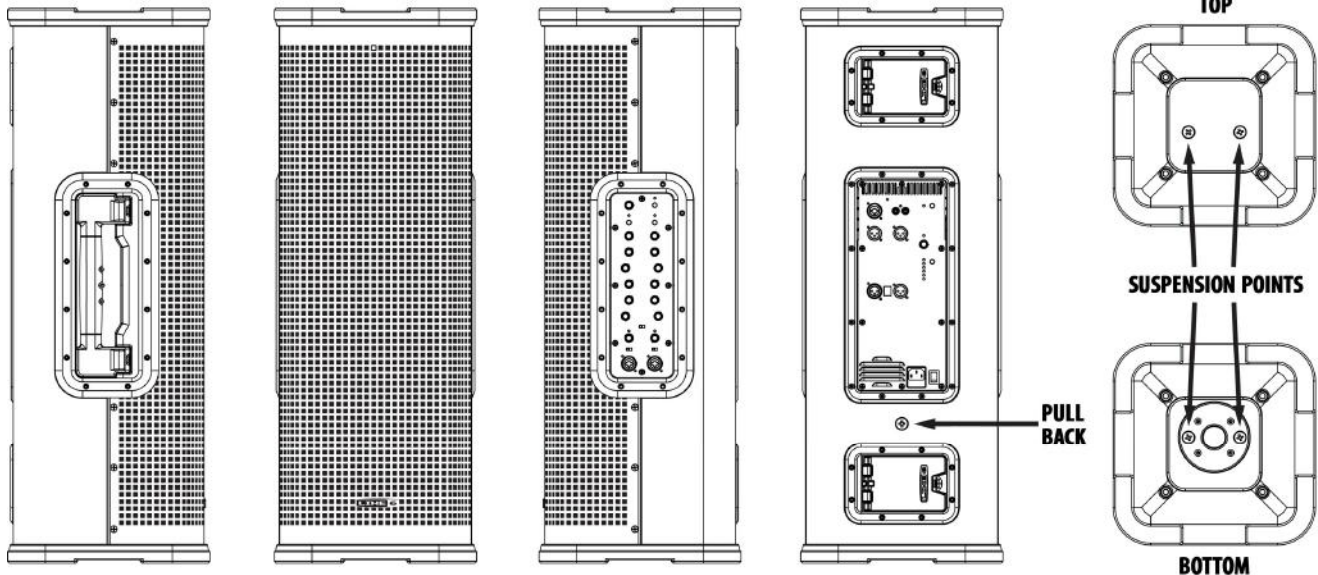
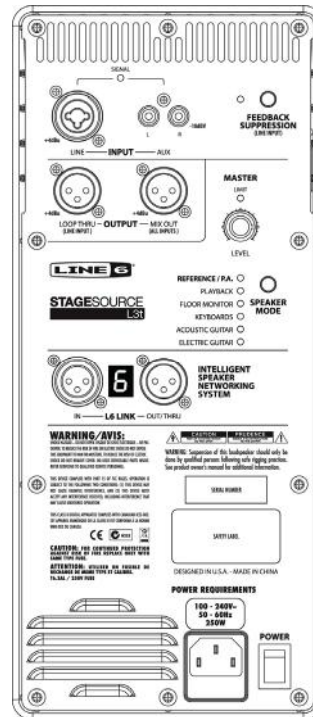

Height	33-7/8" / 861 mm
Width	12-1/4" / 312 mm
Depth	12-1/4" / 312 mm
Weight	57.5 lbs / 26.1 kg

# StageSource L3t

The World's Most Versatile Loudspeaker System for Musicians



Technical Specifications

## Audio Signal Flow

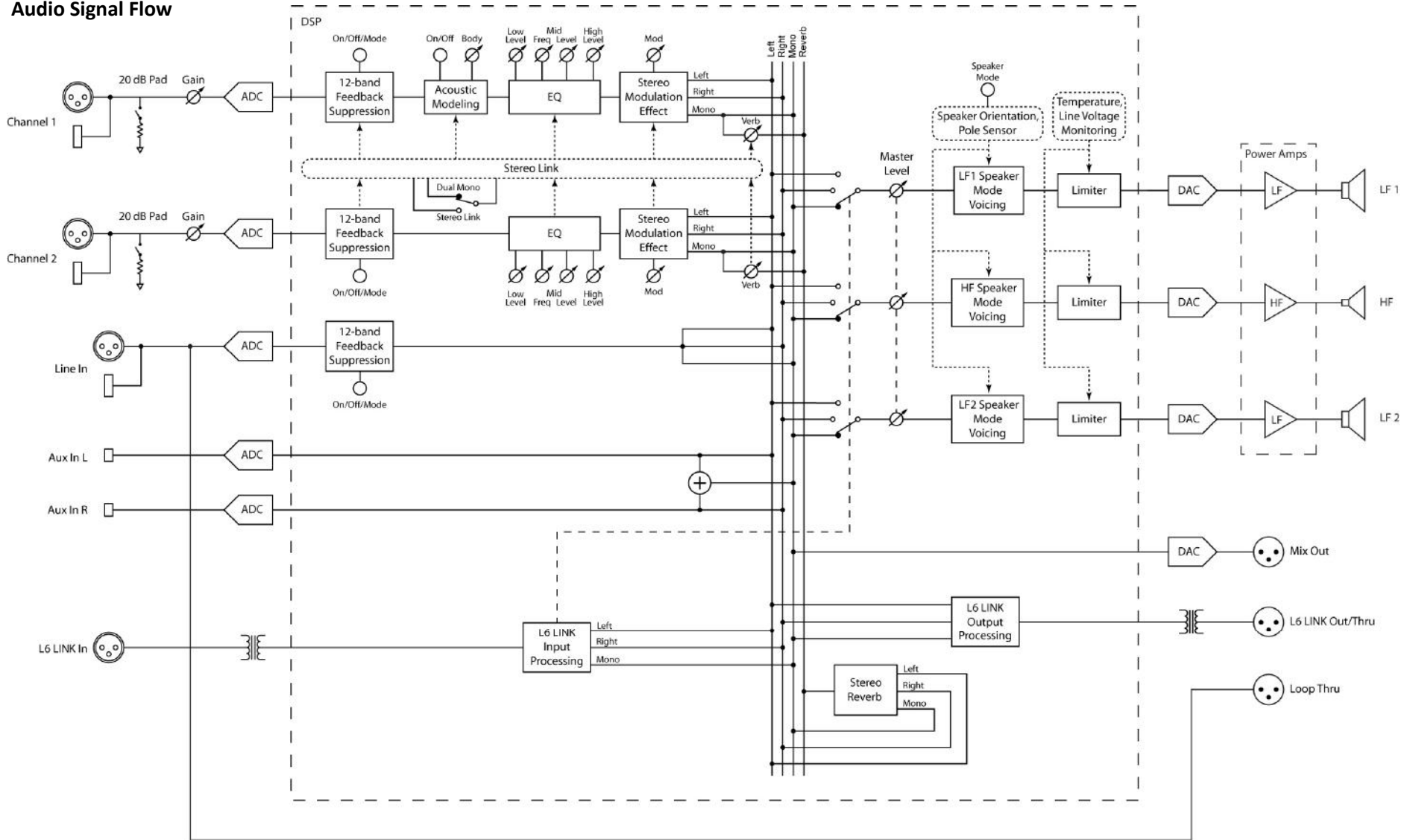

# StageSource L3t

The World's Most Versatile Loudspeaker System for Musicians



Technical Specifications

Note: All measurements taken in Reference/P.A. Speaker Mode.

### Frequency Response

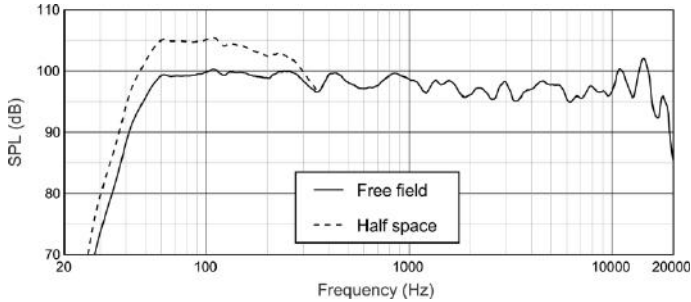

### Beamwidth

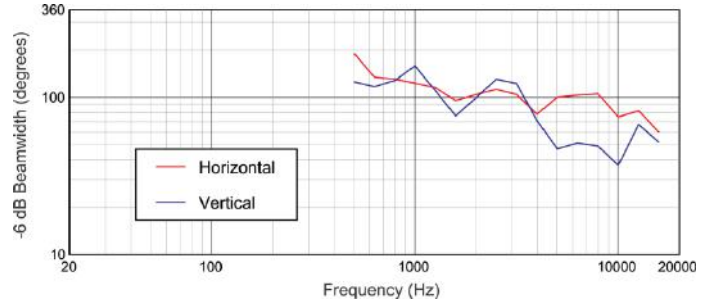

### Directivity Index/Factor

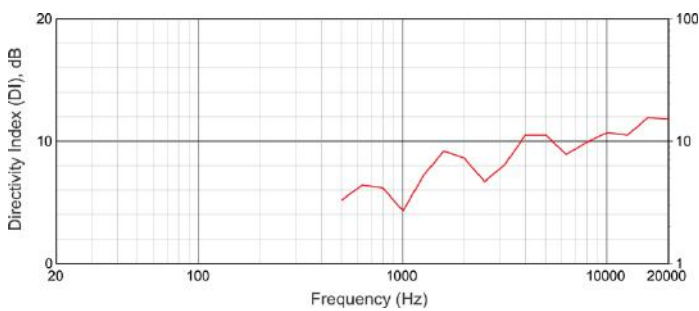

### Off-axis, Horizontal

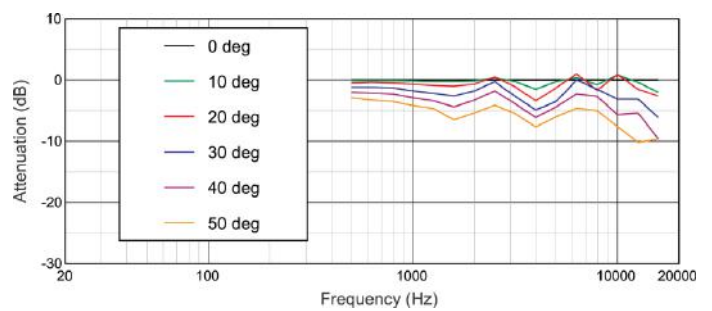

### Off-axis, Vertical Down

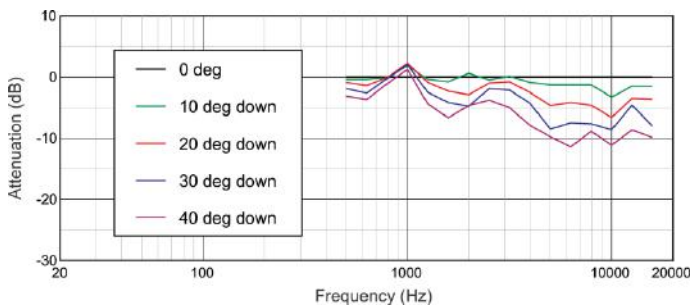

### Off-axis, Vertical Up

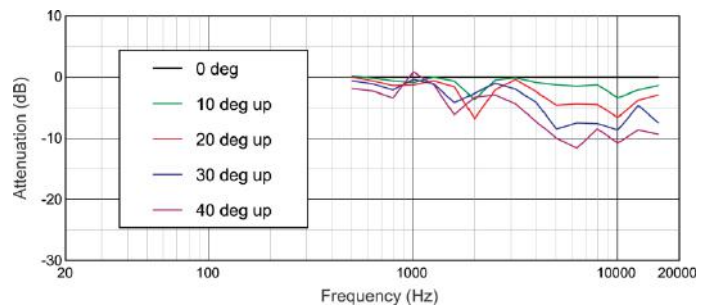



# StageSource L3t

The World's Most Versatile Loudspeaker System for Musicians



Technical Specifications

## Horizontal Polar Response

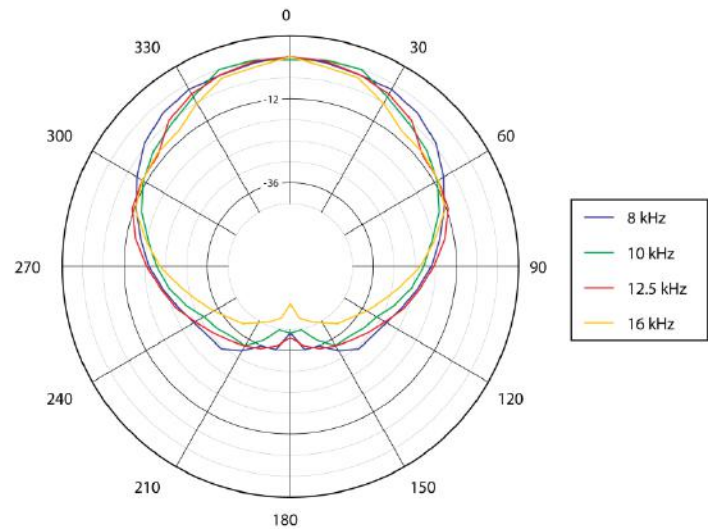
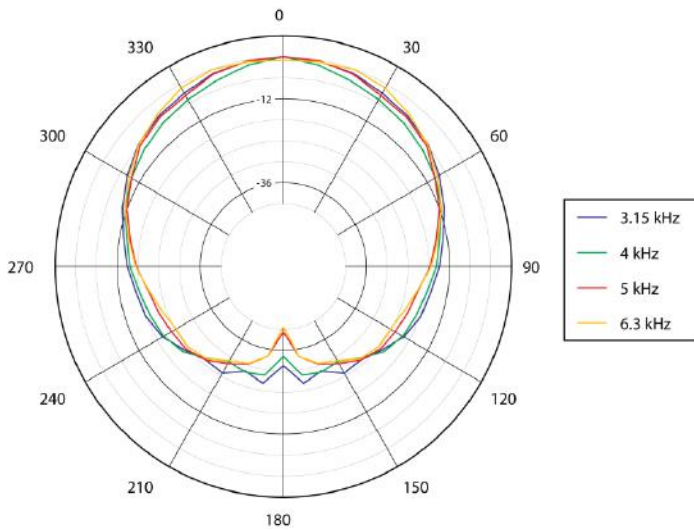
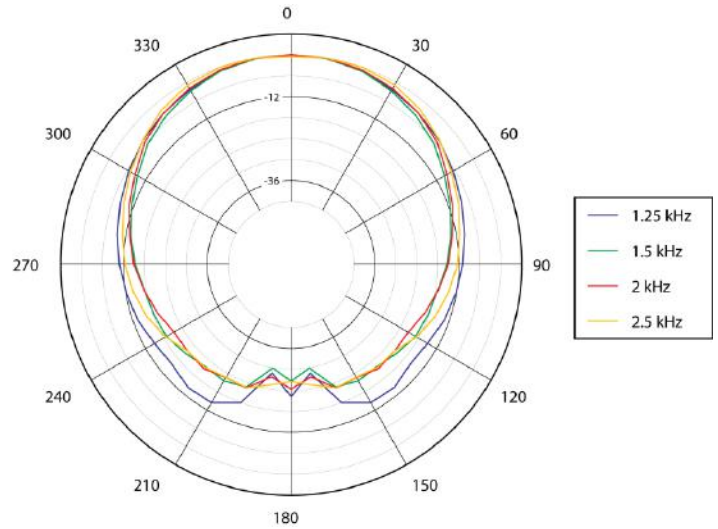
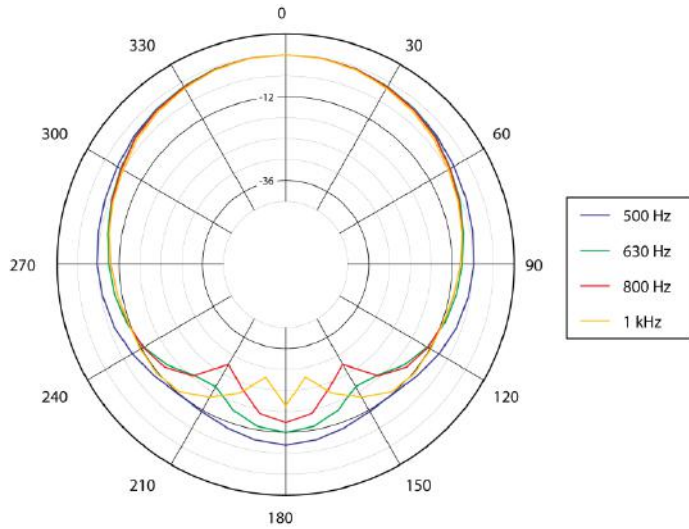

# StageSource L3t

The World's Most Versatile Loudspeaker System for Musicians



Technical Specifications

## Vertical Polar Response

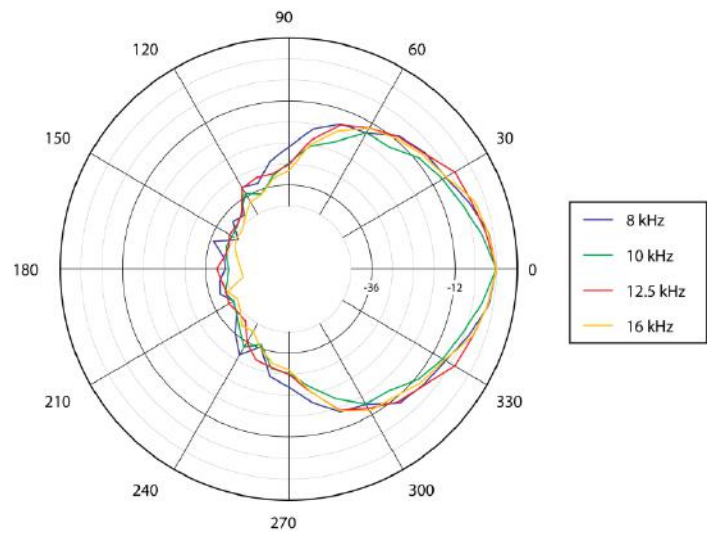
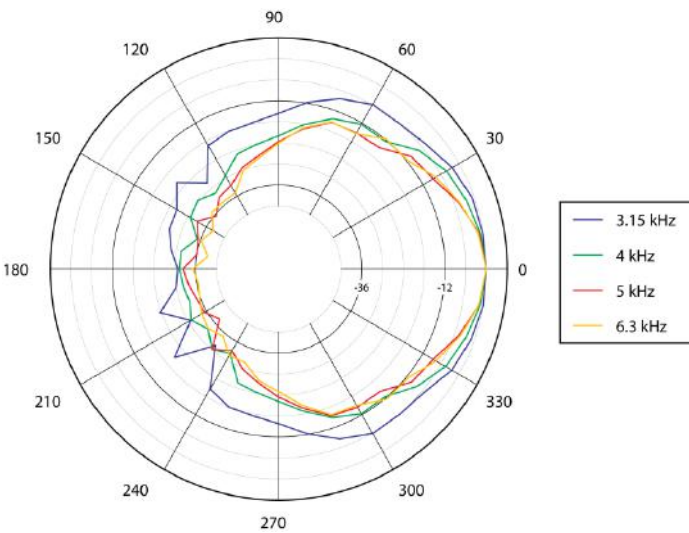
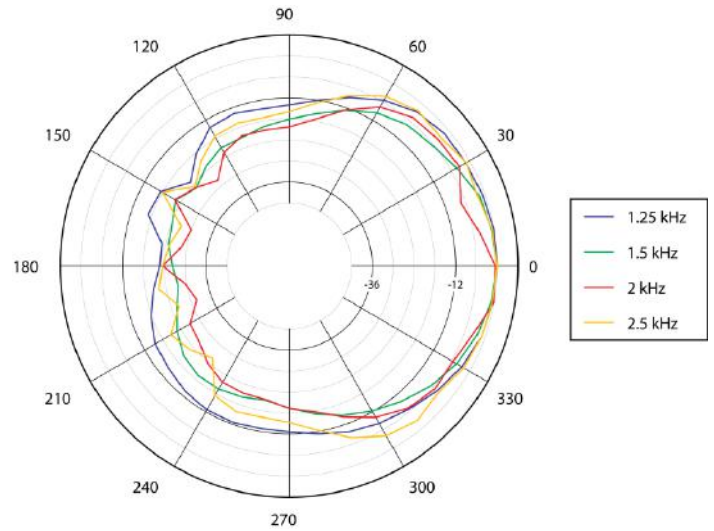
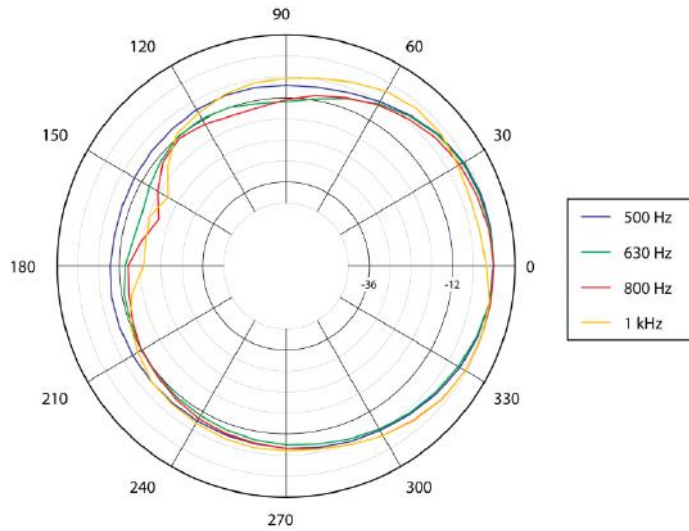

# StageSource L3t

The World's Most Versatile Loudspeaker System for Musicians



Technical Specifications

### Personal PA

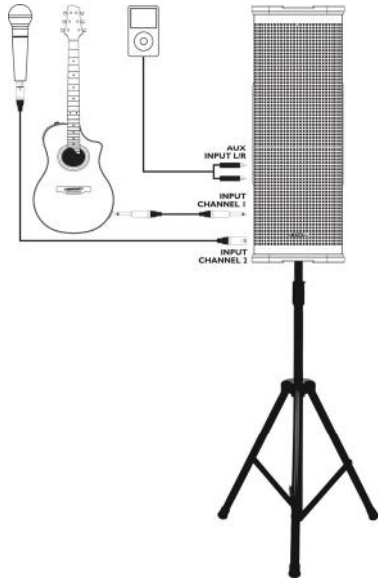

### Duet PA

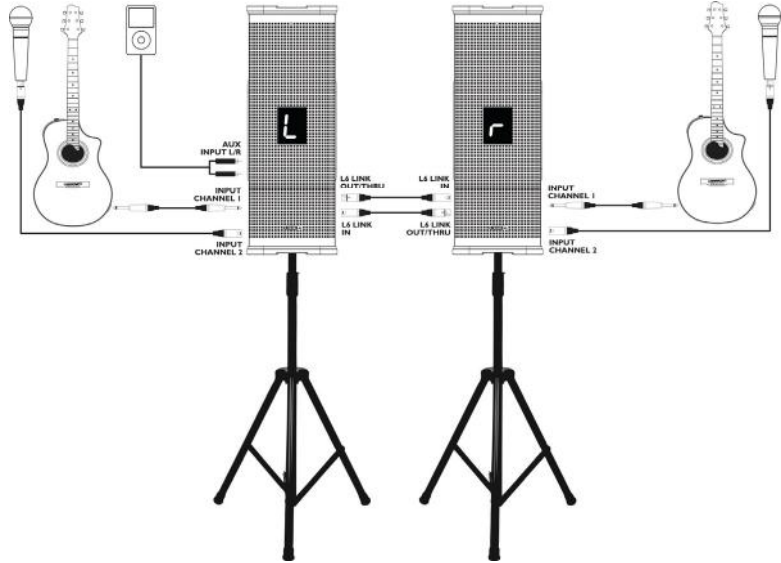

### Small Club PA with Subs and Monitor

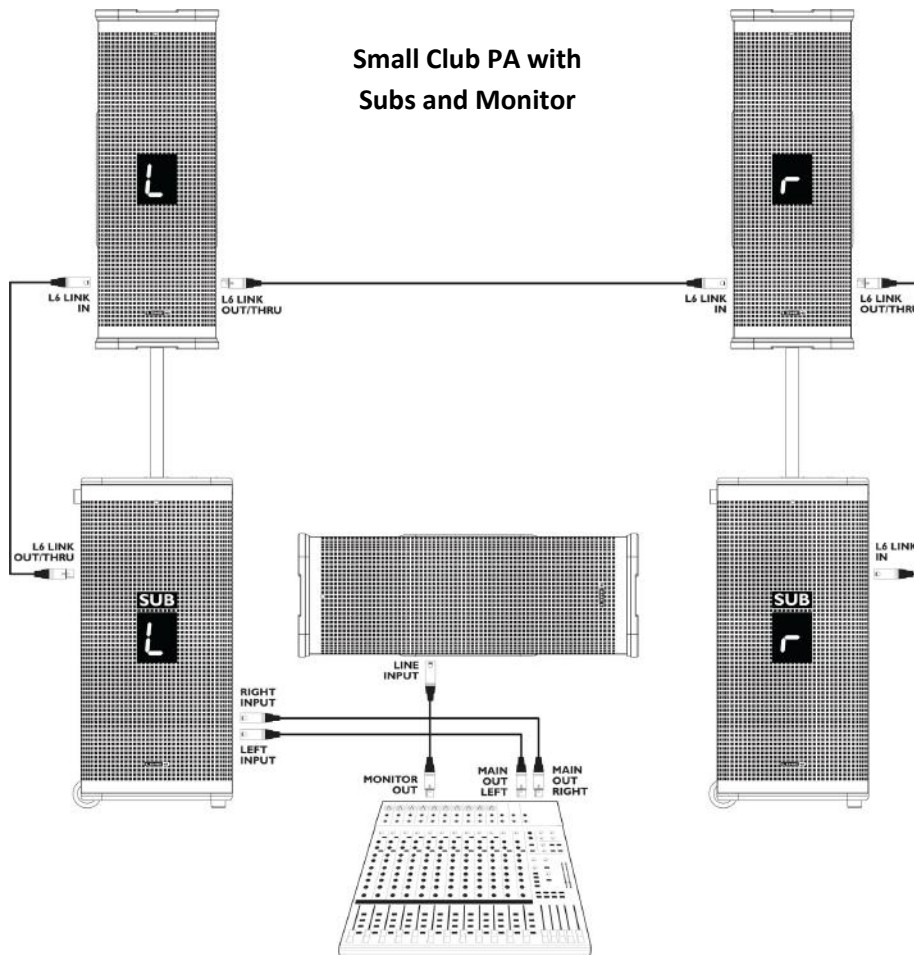



# StageSource L3t

The World's Most Versatile Loudspeaker System for Musicians



Technical Specifications

## Large Scale PA

