

PROFESSIONAL SERIES POWER AMPLIFIERS

PC1002

OPERATING MANUAL



The PC1002 is not just "another big amplifier", it is an exciting new approach to high power sound. Yamaha's leadership is clearly demonstrated by the PC1002's professional features, sophisticated design and uncompromising performance.

The PC1002's performance is as impressive as its features. At a sustained output of 100 watts into 8 ohms (for each channel), there is plenty of punch to reproduce the powerful peaks essential to clean studio monitoring. High power handling also makes the PC1002 an unbeatable choice for live rock or disco sound systems, where an amplifier can really "cook" all night long. Power alone is no virtue; the PC1002 has ultra-low distortion, less than 0.01%THD at ½ rated power – the kind of low distortion that is undetectable by even the most critical listeners.

A high damping factor of better than 180 at 1kHz reduces the tendency for speaker cone overshoot, giving tighter and better defined bass response. On the other end, the PC1002's frequency response extends well beyond 50 kHz, enabling it to accurately reproduce the most complex musical waveforms – even the tortuous output of today's synthesizers. However, high frequency response has not been achieved at the expense of stability; in fact, the PC1002 is rock steady. Even when connected to highly reactive multi-speaker loads, there is no tendency to shut down or "take off" into spurious oscillation.

CONTENTS	
SPECIFICATIONS/DIMENSIONS	2
FRONT PANEL	3
REAR PANEL	4
PERFORMANCE GRAPHS	5
PERFORMANCE OSCILLOGRAPHS	6
BLOCK DIAGRAM	7

SPECIFICATIONS / DIMENSIONS

POWER OUTPUT LEVEL

Continuous average sine wave power with less than 0.05% THD.

20Hz to 20kHz

Stereo, 8 ohms	100W + 100W
Stereo, 4 ohms	150W + 150W
Mono, 16 ohms	200W
Mono, 8 ohms	300W

FREQUENCY RESPONSE

10Hz to 50kHz, 8 ohms, 1W 0^{+0}_{-1} dB

POWER BAND WIDTH

Stereo, 8 ohms, 50W 0.1% THD	10Hz to 100kHz
Mono, 16 ohms, 100W 0.1% THD	10Hz to 100kHz

TOTAL HARMONIC DISTORTION

Stereo, 8 ohms, 50W, 1kHz	Less than 0.005%
Stereo, 8 ohms, 50W, 20Hz to 20kHz	Less than 0.01%
Mono, 16 ohms, 100W, 1kHz	Less than 0.005%
Mono, 16 ohms, 100W, 20Hz to 20kHz	Less than 0.01%

INTER MODULATION DISTORTION

70Hz 7kHz mixed 4 : 1

Stereo, 8 ohms 50W	Less than 0.01%
Mono, 16 ohms 100W	Less than 0.01%

CROSSTALK (CHANNEL SEPARATION)

Minimum attenuator setting	
8 ohms, 50W, 1kHz	80dB
8 ohms, 50W, 20Hz to 20kHz	70dB

DAMPING FACTOR

8 ohms, 1kHz	More than 180
8 ohms, 20Hz to 20kHz	More than 100

S/N RATIO

Input shorted at 12.47kHz	105dB
Input shorted at IHF A	110dB

RISE RATE

Stereo 8 ohms	30V/ μ sec
Mono 16 ohms	55V/ μ sec

INPUT SENSITIVITY

Input level which produces 100W output into 8 ohms
0dB (0.775V rms)

INPUT IMPEDANCE

Maximum attenuator setting	
Balanced input	50 kohms
Unbalanced input	25 kohms

VOLTAGE GAIN

Maximum attenuator setting 31.2dB

RELAY MUTING TIME

From power on 4^{+2}_{-1} sec

INDICATORS

Power ON	LED
Protection (Relay OFF)	LED
Thermal Overload (85 \pm 5 degrees C.)	LED
Clipping (1% THD)	LED

FRONT PANEL CONTROLS

Power Switch	Push-ON/Push-OFF
Input Attenuators	22 detent positions in -1dB steps (0, -1, -2 . . . -20, ∞)

REAR PANEL CONTROLS

Mode switch	STEREO/MONO
Pin 1 GND Switch (XLR connectors)	ON/OFF
Balance/Unbalance Switch	BALANCED (XLR)/ UNBALANCED (PHONE)

POWER REQUIREMENTS

U.S. & CANADIAN models	AC120V 60Hz
GENERAL model	AC220/240V 50/60Hz

POWER CONSUMPTION

U.S. & CANADIAN models	380W
GENERAL model	840W

DIMENSIONS

(W x D x H) 480 x 337 x 140mm
(18-7/8" x 13-1/4" x 5-1/2")

WEIGHT

15.5 kg (34.2 lbs)

NOTE: U.S. & CANADIAN Models must be operated into 8 ohms in stereo mode and 16 ohms in mono mode in accordance with safety regulations.

All specifications subject to change without notice.

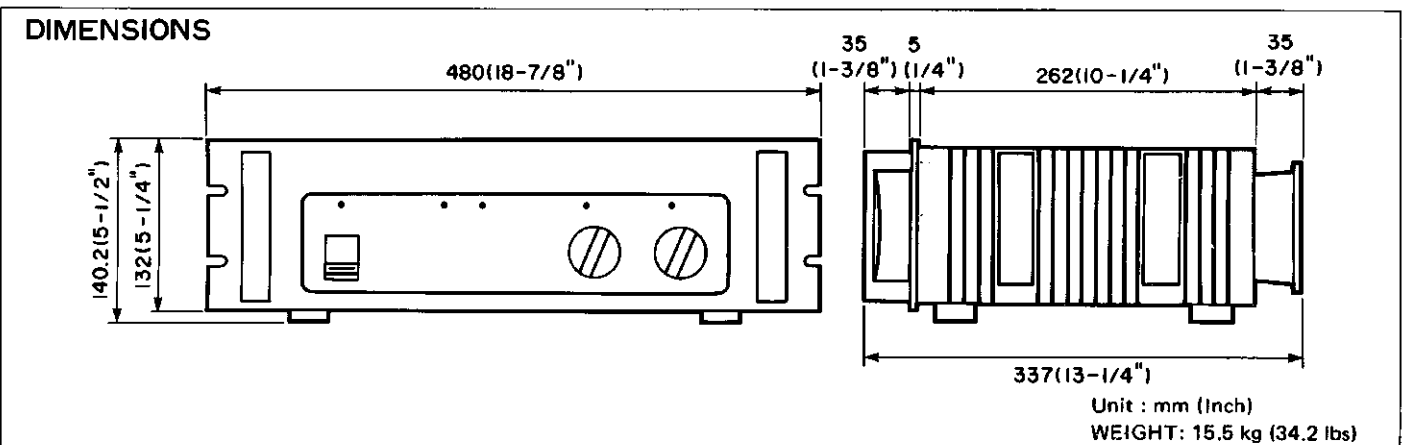

FRONT PANEL

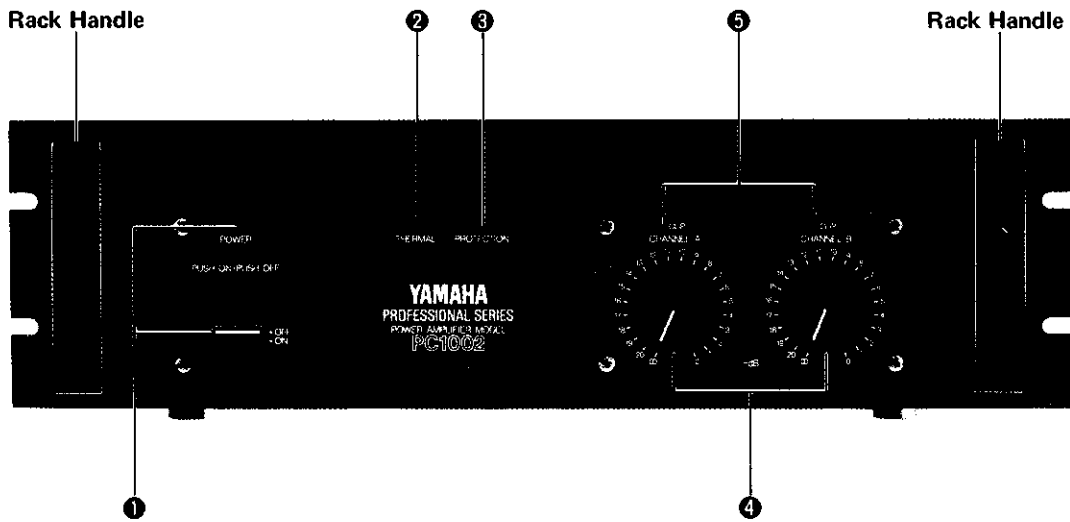

6 Accessories

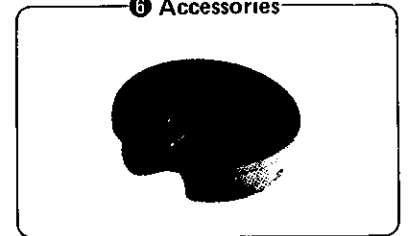

1 POWER Switch/Indicator

Pressing this switch turns power to the amplifier ON and causes the power indicator to light. Pressing the POWER switch a second time turns the unit OFF.

2 THERMAL Indicator

This indicator lights if surface temperature of the main heat sink exceeds 85 ± 5 degrees centigrade.

3 PROTECTION Indicator

Lights for approximately 4 seconds after power is switched on, indicating that the protection circuitry is active. The speaker outputs are shut off while this indicator is lit. If the protection circuitry is activated for any reason during amplifier operation, the indicator will light and the speaker outputs will be shut off. Once the cause of protection activation has been remedied normal operation will resume automatically and the protection indicator will go out.

4 Input Attenuators

These attenuators adjust the sensitivity of the respective amplifier channel in 22, 1dB steps. Attenuation in the fully clockwise position is 0dB, and ∞ in the fully counterclockwise position.

5 CLIP Indicator

This indicates that the amplifier is clipping due to excessive input signal levels.

6 Knob Lock Adaptors (Supplied)

The Knob Lock Adaptors prevent accidental alteration of attenuator settings once the appropriate settings have initially been made.

REAR PANEL

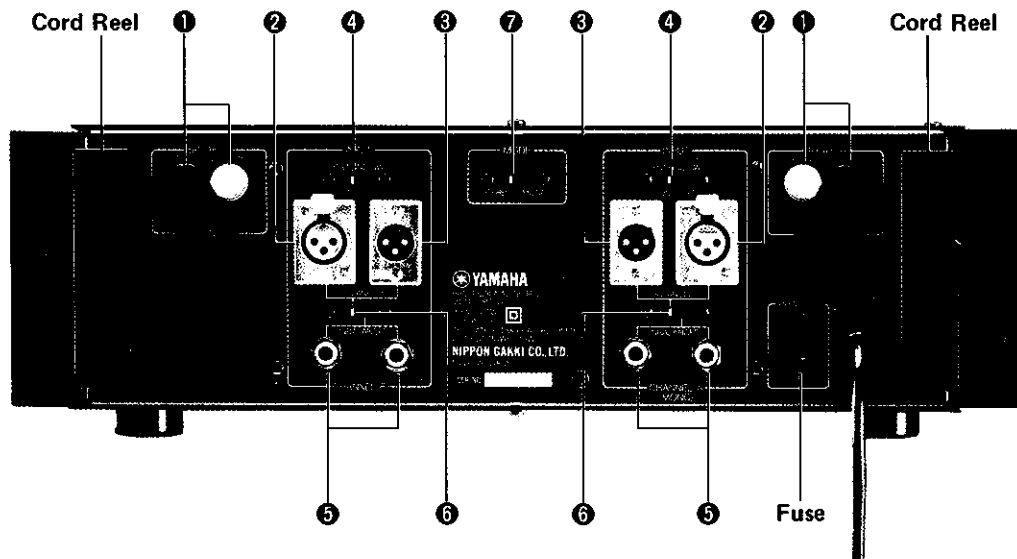

① SPEAKER Output Terminals

The red SPEAKER terminal is connected to the "+" input terminal of the speaker system used and the black SPEAKER terminal is connected to the "-" speaker input terminal.

② Canon Connectors (XLR-3-31)

These connectors are generally used as inputs. Pin 1 is shield, pin 2 is hot and pin 3 cold. Compatible connectors include Canon XLR-3-12C and Switchcraft 5C-1055A.

③ Canon Connectors (XLR-3-32)

Compatible with Canon XLR-3-11C or switchcraft 5C-1056A connectors, these connectors are useful for sending the input signal to other power amplifiers.

④ PIN 1 GND SW

Couples or decouples the canon connector earth line (pin 1, shield). Normally ON. In some cases where ground loops cause excessive hum, turning the ground switch OFF can interrupt the loop and reduce the hum.

⑤ Standard Phone Jacks

These jacks accept unbalanced input via standard 1/4" phone plugs. The BALANCED/UNBALANCED switch should be set to UNBALANCED when using these inputs. These jacks can also be used as send terminals.

⑥ BALANCED/UNBALANCED Switch

Determines which input connectors are active. In the BALANCED position, input signals are accepted via the balanced Canon connectors, and in the UNBALANCED position input is accepted via the unbalanced phone jacks.

⑦ MODE Selector Switch

Determines whether the amplifier is to operate in the stereo or mono (BTL) mode.

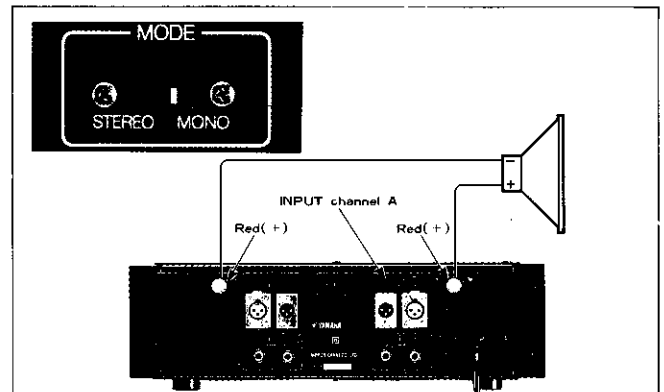

MONAURAL OPERATION

The PC1002 can easily be adapted for monaural (BTL) operation by setting the rear-panel MODE switch to MONO. In the MONO mode use the channel A input connectors and channel A attenuator for level control. The "+" terminal of the speaker system is connected to the channel A "+" output terminal and the "-" terminal of the speaker system is connected to the channel B "+" output terminal. Leave the channel A and B "-" output (SPEAKER) terminals and channel B input terminals unconnected.

PERFORMANCE GRAPHS

FREQUENCY RESPONSE LOAD 8 & 16 ohms
MODE ST/MONO
INPUT BALANCED

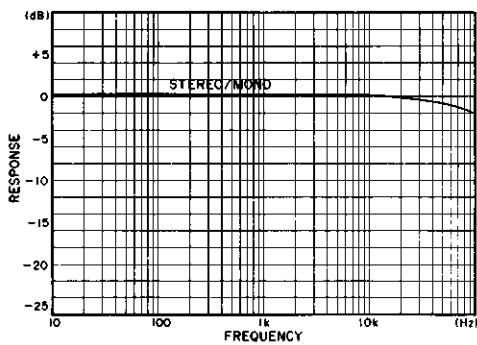

OUTPUT IMPEDANCE LOAD 8 ohms
MODE STEREO

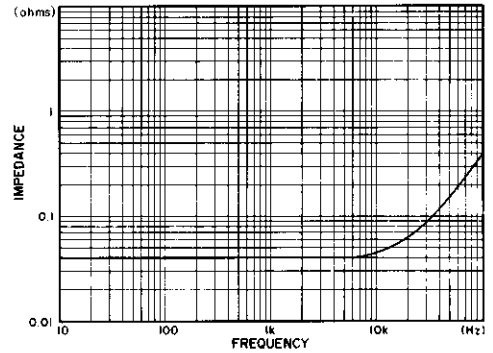

T.H. DISTORTION LOAD 16 ohms
MODE MONO
UNBALANCED INPUT

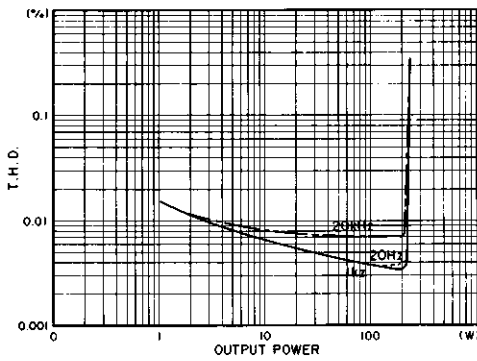

POWER BAND WIDTH THD = 0.05%
LOAD 8 & 16 ohms
MODE ST/MONO
ST, Both CH Driven

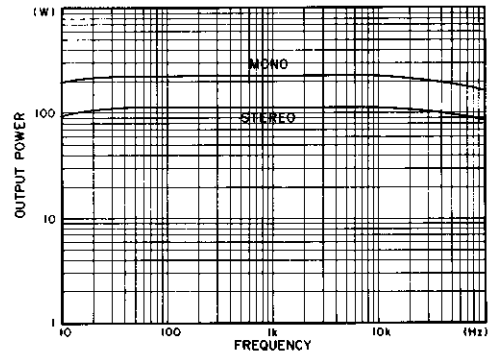

T.H. DISTORTION LOAD 8 ohms
MODE STEREO
Both CH Driven

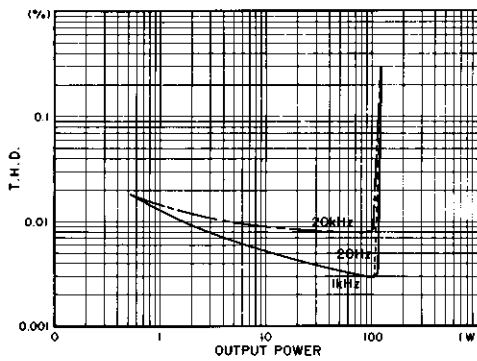

DAMPING FACTOR LOAD 8 ohms
MODE STEREO

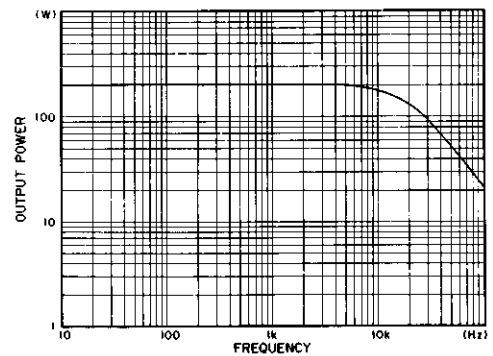

INPUT IMPEDANCE LOAD 8 ohms
MODE STEREO

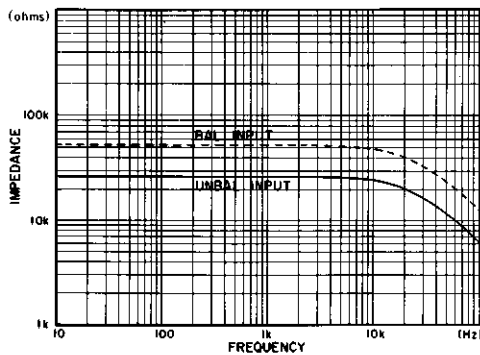

LOAD Vs OUTPUT POWER THD = 0.05%
MODE STEREO
Single CH Driven

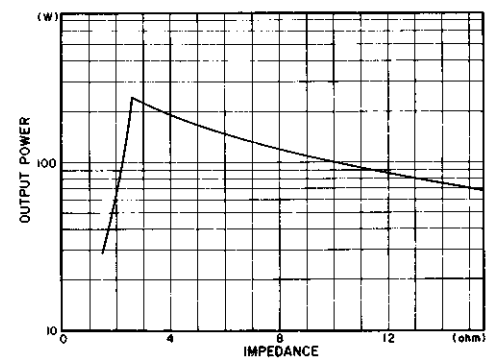

PERFORMANCE OSCILLOGRAPHS

SLEW RATE

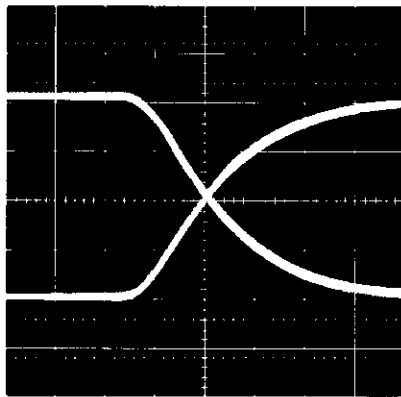

MODE STEREO
30V/ μ sec
LOAD 8 ohms

TOTAL HARMONIC DISTORTION 1 kHz SINE WAVE

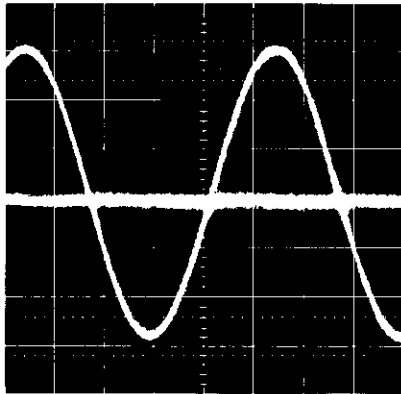

0.0018%
LOAD 8 ohms
MODE STEREO
50W

20 Hz SQUARE-WAVE RESPONSE

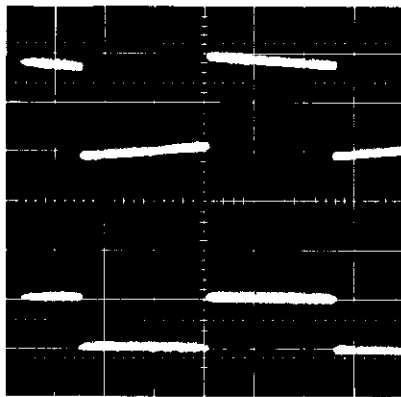

20 kHz SQUARE-WAVE RESPONSE

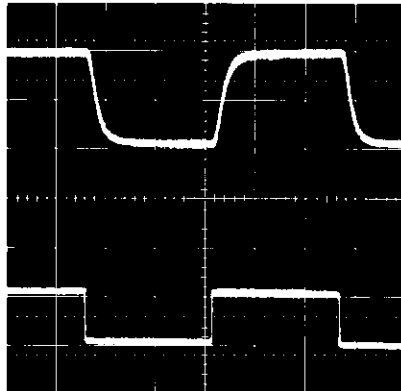

SLEW RATE

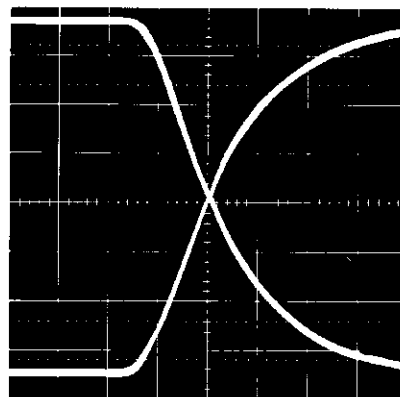

20V/DIV
1 μ sec/DIV

TOTAL HARMONIC DISTORTION 20 kHz SINE WAVE

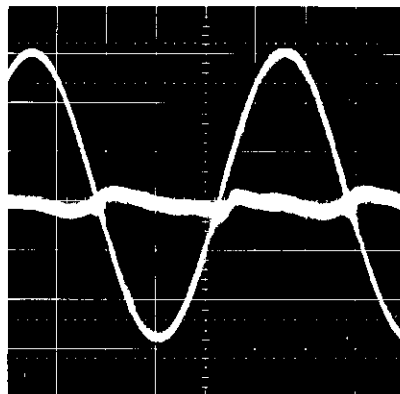

MODE MONO
55V/ μ sec
LOAD 16 ohms

0.0054%
LOAD 16 ohms
MODE MONO
100W

1 kHz SQUARE-WAVE RESPONSE

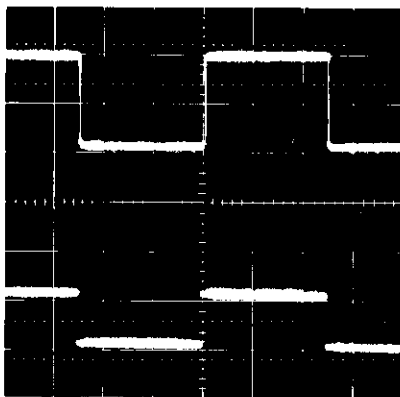

RISE TIME

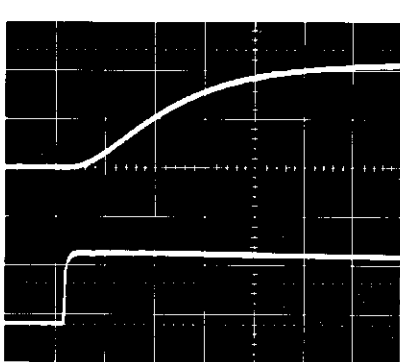

1kHz 1V (10-90%)
3 μ sec or better

* In each photo, output wave form is upside and input wave form is lower.
* Horizontal and vertical scales in each photo are option. But the scales in the photo of Rise time are 0.5V/Div (horizontal) and 1 μ sec/Div (vertical).
* MODE STEREO LOAD 8 ohms.

BLOCK DIAGRAM

PC1002

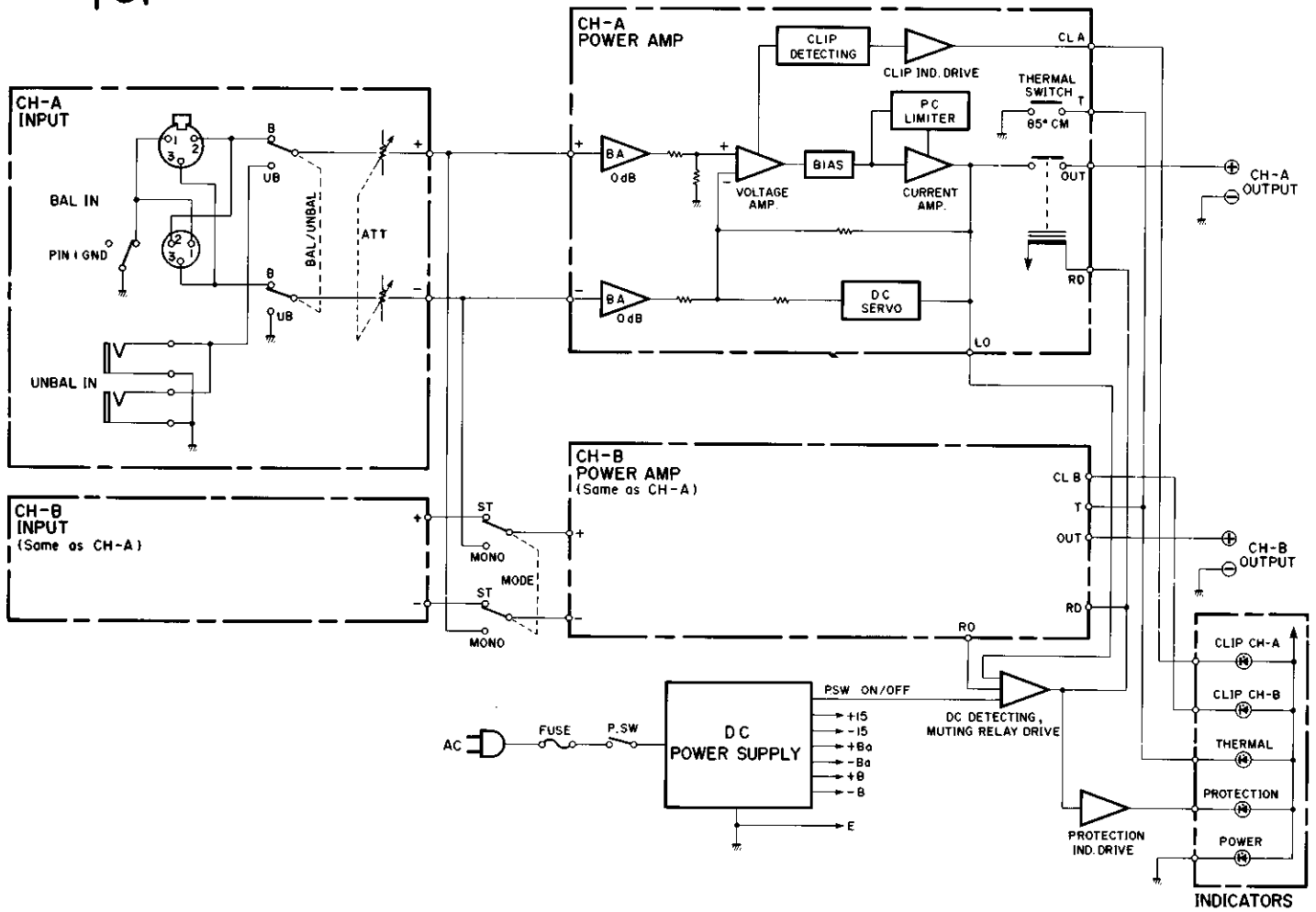

SINCE 1887  **YAMAHA**
NIPPON GAKKI CO., LTD. HAMAMATSU, JAPAN