



POWER AMPLIFIER

XP 7000

XP 5000

XP 3500

XP 2500

XP 1000

OWNER'S MANUAL
BEDIENUNGSANLEITUNG
MODE D'EMPLOI
MANUAL DE INSTRUCCIONES

FCC INFORMATION (U.S.A.)

1. IMPORTANT NOTICE: DO NOT MODIFY THIS UNIT!

This product, when installed as indicated in the instructions contained in this manual, meets FCC requirements. Modifications not expressly approved by Yamaha may void your authority, granted by the FCC, to use the product.

2. IMPORTANT: When connecting this product to accessories and/or another product use only high quality shielded cables. Cable/s supplied with this product MUST be used. Follow all installation instructions. Failure to follow instructions could void your FCC authorization to use this product in the USA.

* This applies only to products (XP7000, XP5000) distributed by YAMAHA CORPORATION OF AMERICA.

(oscillator)

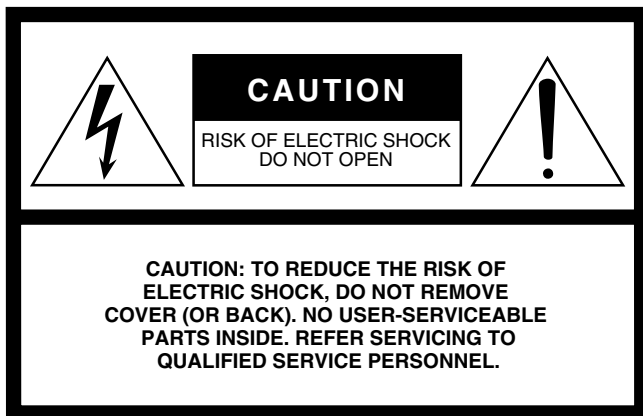

Explanation of Graphical Symbols

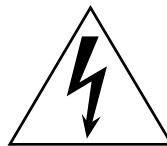

The lightning flash with arrowhead symbol within an equilateral triangle is intended to alert the user to the presence of uninsulated “dangerous voltage” within the product’s enclosure that may be of sufficient magnitude to constitute a risk of electric shock to persons.



The exclamation point within an equilateral triangle is intended to alert the user to the presence of important operating and maintenance (servicing) instructions in the literature accompanying the product.

The above warning is located on the top of the unit.

IMPORTANT SAFETY INSTRUCTIONS

- 1 Read these instructions.
- 2 Keep these instructions.
- 3 Heed all warnings.
- 4 Follow all instructions.
- 5 Do not use this apparatus near water.
- 6 Clean only with dry cloth.
- 7 Do not block any ventilation openings. Install in accordance with the manufacturer’s instructions.
- 8 Do not install near any heat sources such as radiators, heat registers, stoves, or other apparatus (including amplifiers) that produce heat.
- 9 Do not defeat the safety purpose of the polarized or grounding-type plug. A polarized plug has two blades with one wider than the other. A grounding type plug has two blades and a third grounding prong. The wide blade or the third prong are provided for your safety. If the provided plug does not fit into your outlet, consult an electrician for replacement of the obsolete outlet.
- 10 Protect the power cord from being walked on or pinched particularly at plugs, convenience receptacles, and the point where they exit from the apparatus.
- 11 Only use attachments/accessories specified by the manufacturer.
- 12 Use only with the cart, stand, tripod, bracket, or table specified by the manufacturer, or sold with the apparatus. When a cart is used, use caution when moving the cart/apparatus combination to avoid injury from tip-over.
- 13 Unplug this apparatus during lightning storms or when unused for long periods of time.
- 14 Refer all servicing to qualified service personnel. Servicing is required when the apparatus has been damaged in any way, such as power-supply cord or plug is damaged, liquid has been spilled or objects have fallen into the apparatus, the apparatus has been exposed to rain or moisture, does not operate normally, or has been dropped.



WARNING

TO REDUCE THE RISK OF FIRE OR ELECTRIC SHOCK, DO NOT EXPOSE THIS APPARATUS TO RAIN OR MOISTURE.

(98-6500)

PRECAUTIONS

PLEASE READ CAREFULLY BEFORE PROCEEDING

* Please keep this manual in a safe place for future reference.



WARNING

Always follow the basic precautions listed below to avoid the possibility of serious injury or even death from electrical shock, short-circuiting, damages, fire or other hazards. These precautions include, but are not limited to, the following:

Power supply/Power cord

- Only use the voltage specified as correct for the device. The required voltage is printed on the name plate of the device.
- Use only the included power cord.
- Do not place the power cord near heat sources such as heaters or radiators, and do not excessively bend or otherwise damage the cord, place heavy objects on it, or place it in a position where anyone could walk on, trip over, or roll anything over it.
- Be sure to connect to an appropriate outlet with a protective grounding connection. Improper grounding can result in electrical shock.

Do not open

- Do not open the device or attempt to disassemble the internal parts or modify them in any way. The device contains no user-serviceable parts. If it should appear to be malfunctioning, discontinue use immediately and have it inspected by qualified Yamaha service personnel.

Water warning

- Do not expose the device to rain, use it near water or in damp or wet conditions, or place containers on it containing liquids which might spill into any openings.
- Never insert or remove an electric plug with wet hands.

If you notice any abnormality

- If the power cord or plug becomes frayed or damaged, or if there is a sudden loss of sound during use of the device, or if any unusual smells or smoke should appear to be caused by it, immediately turn off the power switch, disconnect the electric plug from the outlet, and have the device inspected by qualified Yamaha service personnel.
- If this device should be dropped or damaged, immediately turn off the power switch, disconnect the electric plug from the outlet, and have the device inspected by qualified Yamaha service personnel.



CAUTION

Always follow the basic precautions listed below to avoid the possibility of physical injury to you or others, or damage to the device or other property. These precautions include, but are not limited to, the following:

Power supply/Power cord

- Remove the electric plug from the outlet when the device is not to be used for extended periods of time, or during electrical storms.
- When removing the electric plug from the device or an outlet, always hold the plug itself and not the cord. Pulling by the cord can damage it.

Location

- Before moving the device, remove all connected cables.
- When setting up the product, make sure that the AC outlet you are using is easily accessible. If some trouble or malfunction occurs, immediately turn off the power switch and disconnect the plug from the outlet. Even when the power switch is turned off, electricity is still flowing to the product at the minimum level. When you are not using the product for a long time, make sure to unplug the power cord from the wall AC outlet.
- Do not use the device in a confined, poorly-ventilated location. If this device is to be used in a small space other than an EIA-standard rack, make sure that there is adequate space between the device and surrounding walls or other devices: at least 5cm at the sides, 10cm behind and 10cm above. Inadequate ventilation can result in overheating, possibly causing damage to the device(s), or even fire.
- Do not expose the device to excessive dust or vibrations, or extreme cold or heat (such as in direct sunlight, near a heater, or in a car during the day) to prevent the possibility of panel discoloration or damage to the internal components.
- Do not place the device in an unstable position where it might accidentally fall over.

- Do not block the vents. This device has ventilation holes at the front and rear to prevent the internal temperature from becoming too high. In particular, do not place the device on its side or upside down. Inadequate ventilation can result in overheating, possibly causing damage to the device(s), or even fire.
- Do not use the device in the vicinity of a TV, radio, stereo equipment, mobile phone, or other electric devices. Doing so may result in noise, both in the device itself and in the TV or radio next to it.
- Do not place the device in a location where it may come into contact with corrosive gases or salt air. Doing so may result in malfunction.

Connections

- Before connecting the device to other devices, turn off the power for all devices. Before turning the power on or off for all devices, set all volume levels to minimum.
- Use only speaker cables for connecting speakers to the speaker jacks. Use of other types of cables may result in fire.
- Be sure to connect to a properly grounded power source. A ground screw is provided on the rear panel of this device for maximum safety and shock prevention. If the mains outlet is not grounded, be sure to connect the ground screw to a confirmed ground point before plugging the device into the mains. Improper grounding can result in electrical shock.

Maintenance

- Remove the power plug from the AC outlet when cleaning the device.

Handling caution

- When turning on the AC power in your audio system, always turn on the device LAST, to avoid speaker damage. When turning the power off, the device should be turned off FIRST for the same reason.
- Do not insert your fingers or hands in any gaps or openings on the device (vents, etc.).
- Avoid inserting or dropping foreign objects (paper, plastic, metal, etc.) into any gaps or openings on the device (vents, etc.) If this happens, turn off the power immediately and unplug the power cord from the AC outlet. Then have the device inspected by qualified Yamaha service personnel.
- Do not use the device for a long period of time at a high or uncomfortable volume level, since this can cause permanent hearing loss. If you experience any hearing loss or ringing in the ears, consult a physician.
- Do not rest your weight on the device or place heavy objects on it, and avoid use excessive force on the buttons, switches or connectors.
- Do not use this device for any purpose other than driving loudspeakers.

Yamaha cannot be held responsible for damage caused by improper use or modifications to the device, or data that is lost or destroyed.

Always turn the power off when the device is not in use.

Even when the power switch is in the "STANDBY", electricity is still flowing to the device at the minimum level. When you are not using the device for a long time, make sure you unplug the power cord from the wall AC outlet.

The performance of components with moving contacts, such as switches, volume controls, and connectors, deteriorates over time. Consult qualified Yamaha service personnel about replacing defective components.

Illustrations in this manual are for explanatory purposes only, and may not match the actual appearance of the product during operation.

Company names and product names used in this Owner's Manual are trademarks or registered trademarks of their respective owners.

IMPORTANT NOTICE FOR THE UNITED KINGDOM Connecting the Plug and Cord

WARNING: THIS APPARATUS MUST BE EARTHED

IMPORTANT. The wires in this mains lead are coloured in accordance with the following code:

GREEN-AND-YELLOW : EARTH
BLUE : NEUTRAL
BROWN : LIVE

As the colours of the wires in the mains lead of this apparatus may not correspond with the coloured markings identifying the terminals in your plug proceed as follows:

The wire which is coloured GREEN-and-YELLOW must be connected to the terminal in the plug which is marked by the letter E or by the safety earth symbol  or colored GREEN or GREEN-and-YELLOW.

The wire which is coloured BLUE must be connected to the terminal which is marked with the letter N or coloured BLACK.

The wire which is coloured BROWN must be connected to the terminal which is marked with the letter L or coloured RED.

- This applies only to products distributed by Yamaha-Kemble Music (U.K.) Ltd. (3 wires)

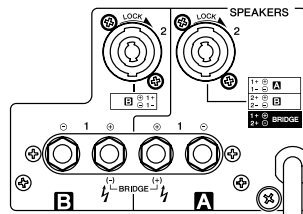

This ⚡ mark indicates a dangerous electrically live terminal. When connecting an external wire to this terminal, it is necessary either to have "a person who have received appropriate guidance on handling" make the connection or to use leads or a cord that have been manufactured in such a way that the connection can be made simply and without problem.

Introduction

Thank you for purchasing a Yamaha XP7000, XP5000, XP3500, XP2500, XP1000 Series Power Amplifier.

The XP Series of power amplifiers was developed from Yamaha's wealth of experience in building PA equipment and its tradition of careful attention to every detail of circuit design. These power amplifiers feature high power — thanks to EEEngine (Energy Efficient Engine) technology — and superb quality together with superior reliability and stability, guaranteeing the highest possible audio performance.

Main features include

- Three modes are provided to support a broad range of applications: STEREO mode which can be driven by two independent sources, PARALLEL mode in which a monaural source drives both channels, and BRIDGE mode in which the two internal amps function as a single high-power mono amp.
- Balanced XLR connector and Euroblock connector inputs, and Speakon connector and five-way binding post outputs are provided.
- A high pass filter switch that enables selection of the cutoff frequency (20Hz or 55Hz).
- Signal indicator, clip indicator and sophisticated dB step Volume control are provided for each channel.
- A PROTECTION indicator that shows the state of various protection systems (power on/off detection, output protection, DC detection), a TEMP indicator that indicates heat sink overheating, and a POWER/STANDBY indicator that indicates the power status.
- Variable-speed low-noise fans ensure high reliability.
- The XP7000 enables parallel connection of multiple high-impedance speakers that support 70V line output.
- The XP3500 enables parallel connection of multiple high-impedance speakers that support 100 V line output.
- A MONITOR/REMOTE terminal that allows monitoring or control over the amplifier via a network.

This Owner's Manual applies to the XP7000, XP5000, XP3500, XP2500, XP1000 power amplifier. In order to take full advantage of your power amplifier and enjoy long and trouble-free operation, please read this Owner's Manual carefully before using your Power Amplifier.

Contents

Controls and Functions	6
Front Panel	6
Rear Panel	7
Speaker Connections	8
Stereo Mode	8
Parallel Mode	8
Bridged Mode (use as high-power mono amplifier)	9
High-impedance speaker connections ..	10
Connection	11
Using a Euroblock connector	11
Speaker Connection	11
Troubleshooting	12
Specifications	13
General Specifications	13
MONITOR/REMOTE PIN layout	15
Dimensions	15
Block Diagram	16
Current Draw	18

Controls and Functions

■ Front Panel

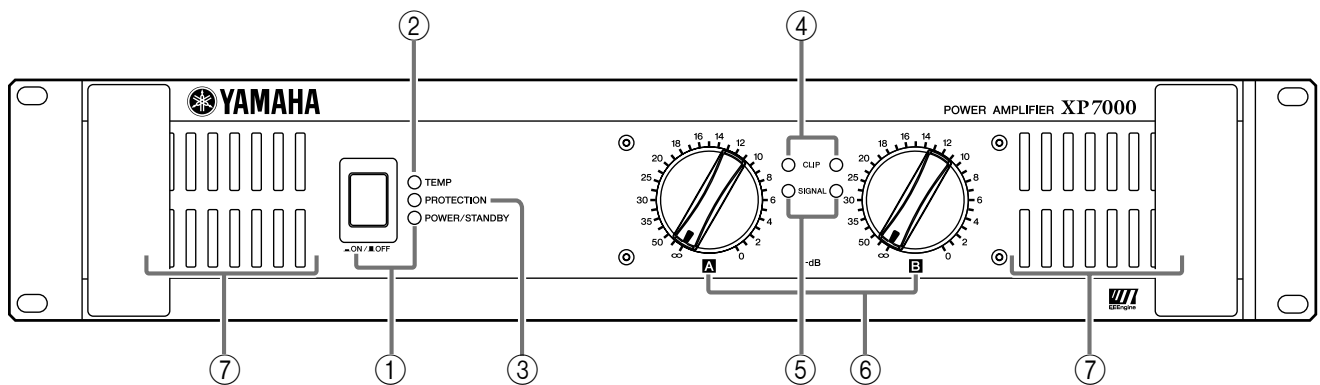

* The illustration shows model XP7000.

① POWER switch and indicator

Press this to turn the power on or off. The POWER/STANDBY indicator lights up in green when the power is ON. If the amplifier has been set to STANDBY mode, the indicator is lit in orange.

② TEMP indicator

Lights up red if the heat sink temperature exceeds 85°C (185°F).

③ PROTECTION indicator

When the protection system is active, the PROTECT indicator light up in red and the speakers are automatically disconnected from the amplifier's outputs. The protection system activates in the following situations:

When the amplifier is turned on

The protection system activates for approximately three seconds when the amplifier is turned on. After three seconds, the protection system deactivates automatically and the amplifier is ready for normal operation.

If a DC voltage is detected at the amplifier's outputs

XP7000/5000: Power shut down and the indicator is not lit.

XP3500/2500/1000: The protection system is active. Once the DC voltage problem is corrected, the protection system deactivates automatically and the amplifier is ready for normal operation.

If the amplifier overheats

When overheating occurs, the PROTECT/MUTE indicator lights. You should immediately turn off the amplifier and allow it time to cool down. See the Precautions section of this Owner's Manual for ways to prevent the amplifier from overheating.

④ CLIP indicator

Lights up red when the output signal distortion on the corresponding channel rises above 1% — indicating that "clipping" has occurred because the signal level is too high.

⑤ SIGNAL indicator

Lights up green when the corresponding channel's output level exceeds 2 V_{rms} (equivalent to 1/2 W into an 8 Ω load, or 1 W into a 4 Ω load).

⑥ Volume control knobs

Each control knob adjusts the volume of the corresponding channel, in 31 steps from -∞ dB to 0 dB.

* If you wish to lock in the knob settings, you can fasten the supplied security cover over the knobs so that the settings will not be disturbed.

● How to install the security cover

- (1) Use the supplied hex wrench to remove the four attachment screws from the amplifier.
- (2) Adjust the security cover to the position of screw holes. Fasten it into place using the same screws.

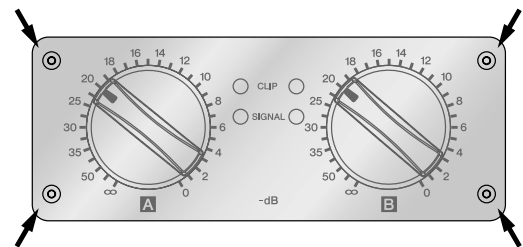

⑦ Air intakes

The amplifier uses forced-air cooling. The cooling fans draw air in from the front and exhaust it through the rear. Please be sure that you do not block the air intakes or exhaust vents.

* The fans do not come on at initial power-on, but will switch on automatically when the temperature of the heat sink rises above 50°C (122°F). The fan speed will then vary automatically as the temperature changes.

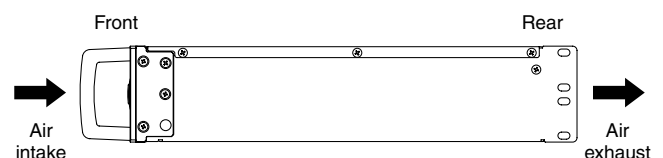

■ Rear Panel

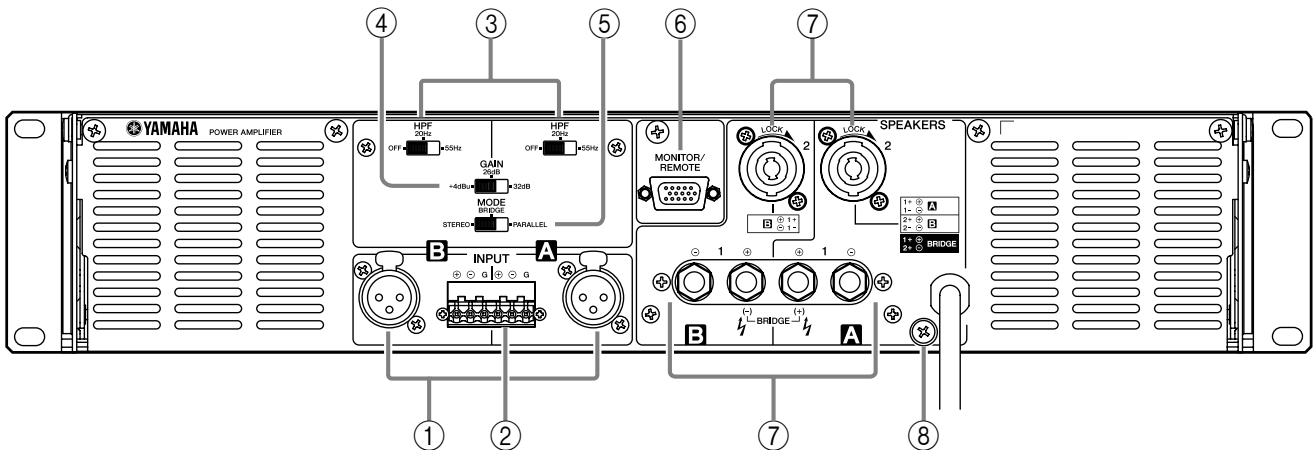

① XLR inputs connectors

These balanced XLR-3-31 type connectors are used to connect input signals. The pins are wired as shown below (IEC 60268).

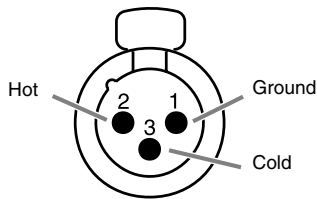

* In bridged mode, only the first channel in the pair is active; i.e., channel A of pair A/B. Make sure not to input an audio signal to an inactive input terminal.

② Euroblock connectors

These balanced Euroblock connectors are used to connect input signals.

③ HPF switches

These switches are used to turn on and off the HPF (High Pass Filter) for each channel. When this is set to 20Hz or 55Hz, frequencies below the respective settings are filtered using a 12 dB/octave high pass filter.

④ GAIN switch

This switch is used when changing the Gain of the A and B channels simultaneously.

- +4dBu: The maximum output power can be obtained when +4dBu is input.
- 26dB: Setting of 26dB
- 32dB: Setting of 32dB

⑤ MODE switch

• STEREO mode

In STEREO mode, channels A and B are completely independent.

• PARALLEL mode

In PARALLEL mode, the channel A input signal is sent both to the channel A power amp and the channel B power amp. In this case, loads are automatically connected between the A and B input terminals.

• BRIDGED mode

In BRIDGED mode, channels A and B operate simultaneously, functioning as a single mono amplifier.

Note: When in PARALLEL and BRIDGED modes, input terminals A and B are shorted automatically. Make sure not to input an audio signal to an inactive input terminal.

⑥ MONITOR/REMOTE terminals

This terminal is used to connect the external device for monitoring or remote control. Refer to “MONITOR/REMOTE PIN layout” on page 15.

⑦ SPEAKERS terminals

- 1: These 5-way binding posts are used to connect speakers.
- 2: These are Speakon type output jacks. Speakon type cable plugs can be connected here.

⑧ GND terminal

If you are having a problem with hum or noise, use this terminal to connect to ground (earth) or to connect to the chassis of a mixer, preamp, or other device in your system.

Speaker Connections

Speakers can be connected to the amplifier in three ways, as shown below. Note that speaker impedance will vary according to the connection method and the number of speakers. Please be sure that your speaker's impedance is not less than the relevant minimum value indicated below.

■ Stereo Mode

Set the Mode switch to STEREO to use the unit as a stereo amplifier. The volume controls on the front panel (A and B) let you control the volume of each channel independently.

● 5-way binding post

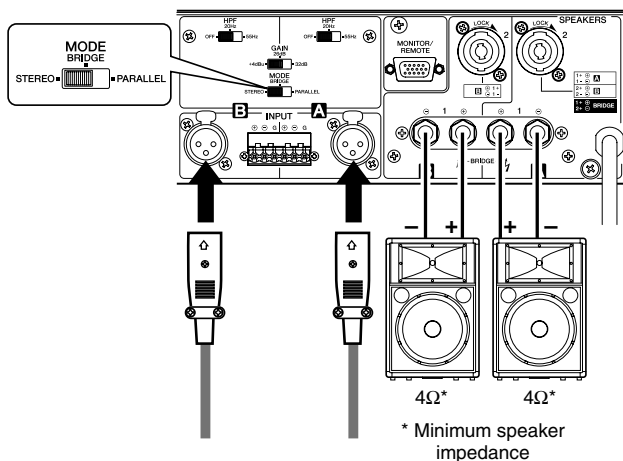

● Speakon connector

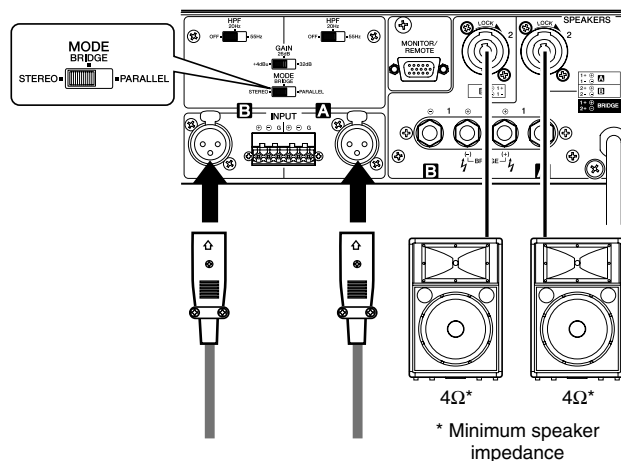

■ Parallel Mode

Set the Mode switch to PARALLEL to use the unit as a two-channel mono amplifier. The volume controls on the front panel (A and B) let you control the volume of each channel independently.

Note: In this case, the loads for A and B are connected directly in the amplifier. Make sure not to input any signal to the B terminal.

● 5-way binding post

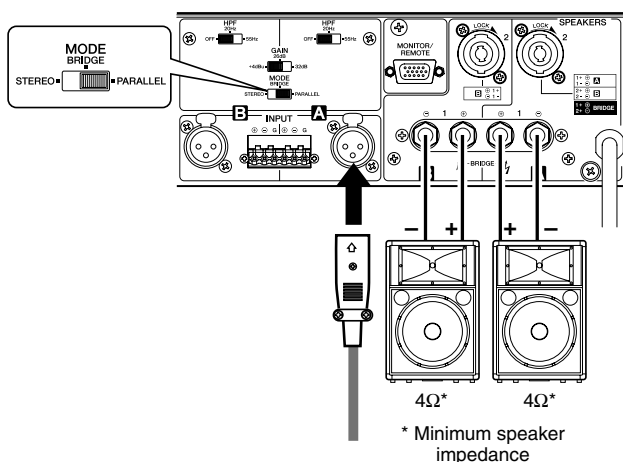

● Speakon connector

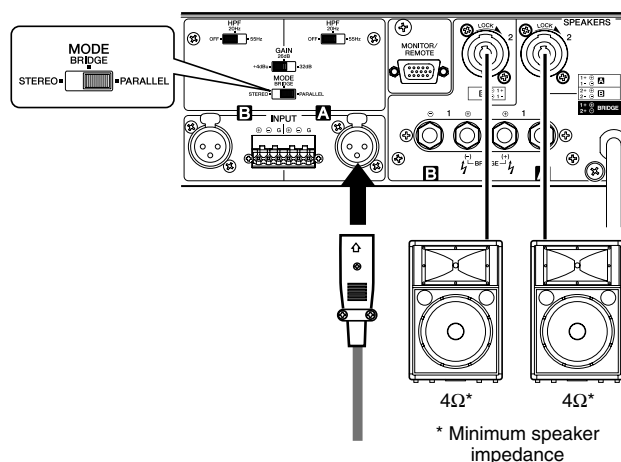

■ Bridged Mode (use as high-power mono amplifier)

Set the Mode switch to BRIDGE to use the unit as a high-power mono amplifier. The volume control A on the front panel A lets you control the volume.

Note: In this case, the loads for A and B are directly connected in the amplifier. Make sure not to input any signal to the B terminal.

● 5-way binding post

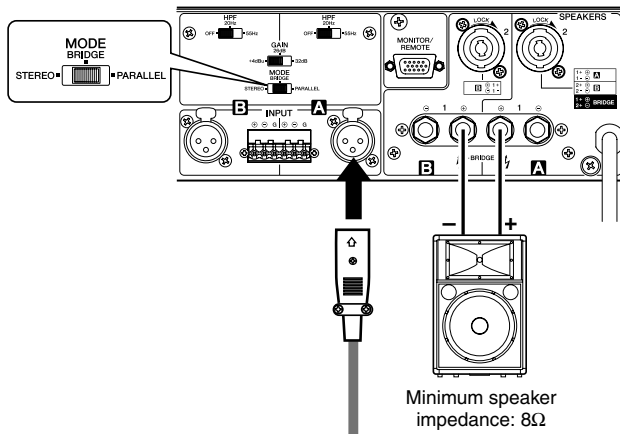

● Speakon connector

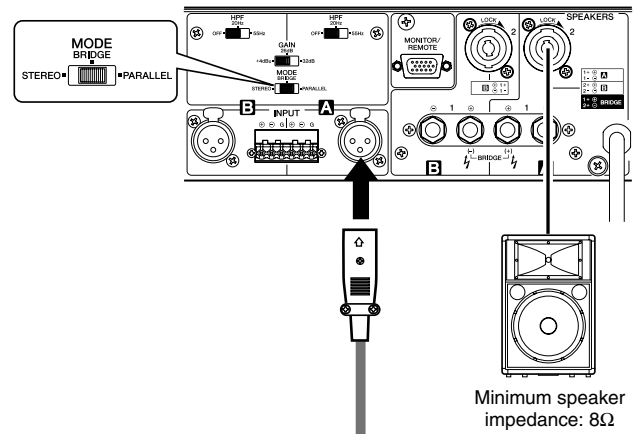

High-impedance speaker connections (XP7000/3500 only)

The **XP7000** enables you to connect in **stereo or parallel fashion** multiple high-impedance speakers that support **70V** line output.

The number of speakers that can be connected varies depending on the speaker's rated input. You can connect speakers with a total rated input per channel of up to **625 W**.

For example, if you are using speakers with a rated input of 10 W and 15 W, you can connect up to 31 speakers at 10 W (for 310W), and 21 speakers at 15 W (for 315 W). The total is 625 W per channel.

CAUTION

Be sure to use speakers that support the XP7000's line-out voltage of **70 V**.

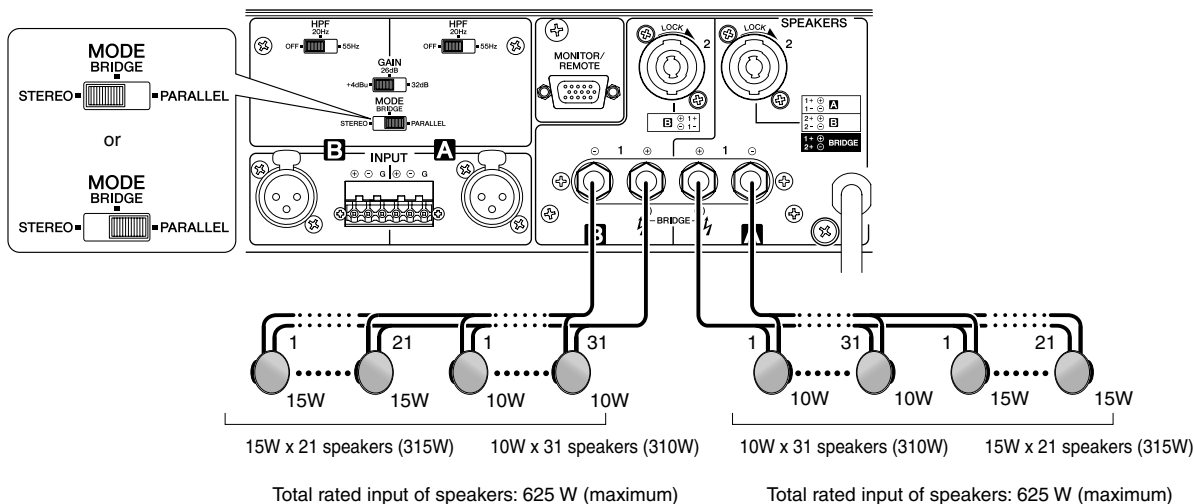

The **XP3500** enables you to connect in **bridge fashion** multiple high-impedance speakers that support **100V** line output. You can connect speakers with a total rated input of up to **625 W**.

CAUTION

Be sure to use speakers that support the XP3500's line-out voltage of **100 V**.

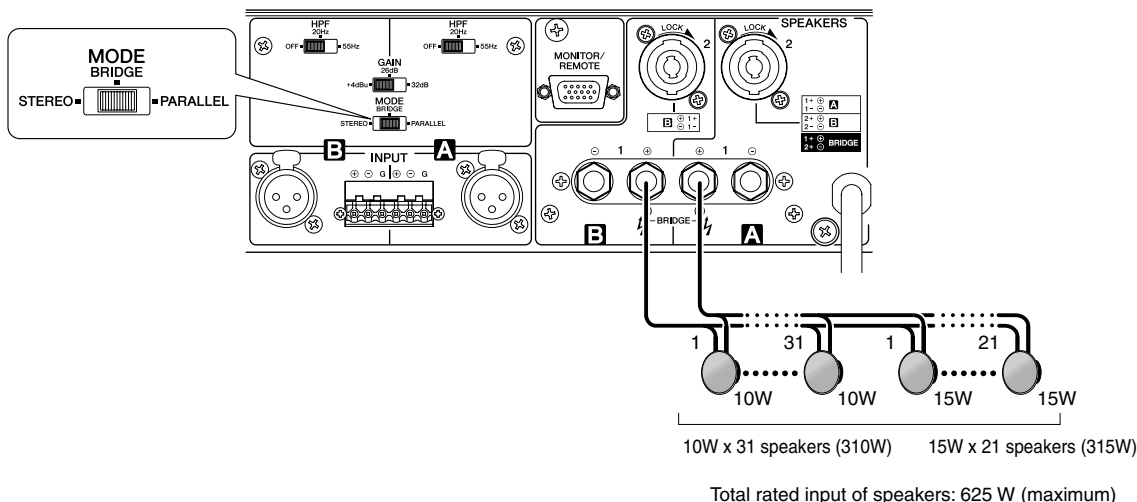

Connection

■ Using a Euroblock connector

If cables will be frequently connected and disconnected, as in the case of a portable installation, we recommend that you use ferrules with insulation sleeves. Use a ferrule whose conductor portion has an external diameter of 1.6mm or less, and a length of approximately 7 mm (such as the AI0,5-6WH made by the Phoenix Contact corporation).

- 1 If the wire insertion ports are closed, turn the screws on top of the connector counterclockwise to open the ports.
- 2 Insert the wires into the appropriate ports, following the indication of the pole on the input terminal, turn the screws on top of the connector clockwise to fix the wires.
- 3 Attach the Euroblock connector to the input terminal on the unit.

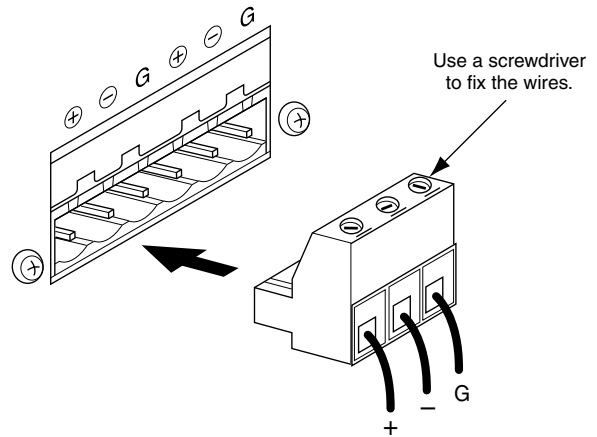

■ Speaker Connection

● 5-way binding post

- 1 Turn off the POWER switch.
- 2 Remove the cover attachment screws and remove the protective cover from the speaker terminals.



- 3 Remove about 15 mm of insulation from the end of each speaker cable. Pass the bare wire through the holes in the appropriate speaker terminals. Tighten the terminals to securely clamp the wires. Refer to page 8 for speaker polarities.

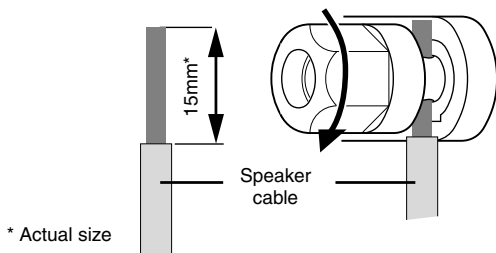

Be sure that the bare wire ends do not jut out from the terminals and touch the chassis.

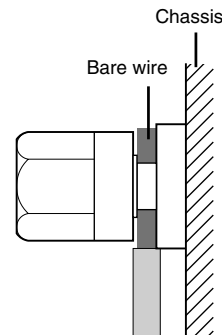

- 4 Reattach the protective cover over the speaker terminals.

● Speakon connector

- 1 Turn off the POWER switch.
- 2 Insert the Neutrik NL4FC plugs into the Speakon connector on the rear of the amplifier, and turn clockwise to lock.

Neutrik NL4FC plugs

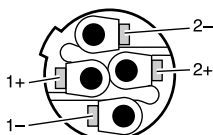

CHANNEL [A] STEREO or PARALLEL

1+	A+
1-	A-
2+	B+
2-	B-

BRIDGE

1+	+
1-	
2+	-
2-	

CHANNEL [B]

1+	B+
1-	B-

Troubleshooting

The following table lists the main causes of abnormal operation and the corrective measures required as well as the protective circuit operation in each case.

Indicator(s)	Possible Cause	Remedy	Protection Circuit
CLIP indicator lights.	There is a short at a speaker terminal, amplifier terminal, or wire.	Locate and correct the cause of the short.	The PC limiter circuit operates to protect the power transistors.
	The amplifier load is excessive.	Use a speaker system with an impedance of at least 4 Ω (STEREO/PARALLEL mode) or 8 Ω (BRIDGE mode).	
TEMP indicator lights.	The heat sink temperature has exceeded 85°C (185°F).	Check the ventilation slots, and provide better airflow around the amplifier.	The TEMP indicator lights up to indicate temperature warning.
PROTECTION indicator lights.	The heat sink temperature has exceeded 90°C (194°F).	Check the amplifier ventilation conditions and take appropriate measures to improve the airflow around the amplifier.	The thermal protection circuit operates to protect the power transistors.

● XP3500, XP2500

Indicator(s)	Possible Cause	Remedy	Protection Circuit
PROTECTION indicator lights.	A DC voltage of +2 V/-2 V or greater was generated in the power amplifier's output circuit.	Consult your dealer or the nearest Yamaha service center.	The relay operates to protect the speaker system.

● XP7000, XP5000

Indicator(s)	Possible Cause	Remedy	Protection Circuit
Power has been shut down. (All indicators are off.)	A DC voltage of +2 V/-2 V or greater was generated in the power amplifier's output circuit.	Consult your dealer or the nearest Yamaha service center.	The protection circuitry shut off the power to protect the speaker system.

Specifications

■ General Specifications

XP7000				120 V	230 V	240 V
Output Power	1 kHz THD+N= 1 %	8 Ω/STEREO	MIN	750 W + 750 W	750 W + 750 W	750 W + 750 W
		4 Ω/STEREO		1100 W + 1100 W	1100 W + 1100 W	1100 W + 1100 W
		8 Ω/BRIDGED		2200 W	2200 W	2200 W
	20 –20 kHz THD+N= 0.1 %	8 Ω/STEREO		700 W + 700 W	690 W + 690 W	700 W + 700 W
		4 Ω/STEREO		950 W + 950 W	950 W + 950 W	950 W + 950 W
		70 V/STEREO RL=8 Ω		625 W + 625 W	625 W + 625 W	625 W + 625 W
	1 kHz 20mS nonclip	8 Ω/BRIDGED		1900 W	1900 W	1900 W
		2 Ω/STEREO		1600 W + 1600 W	1600 W + 1600 W	1600 W + 1600 W
	4 Ω/BRIDGED	3200 W	3200 W	3200 W		
SN Ratio	20Hz-20kHz	(DIN AUDIO)	MIN	104 dB		
Power Consumption	Standby / Idle			5 W / 35 W		
	1/8 (4 Ω/Pink noise)			650 W	650 W	650 W
XP5000				120 V	230 V	240 V
Output Power	1 kHz THD+N= 1 %	8 Ω/STEREO	MIN	525 W+525 W	525 W+525 W	525 W+525 W
		4 Ω/STEREO		750 W+750 W	750 W+750 W	750 W+750 W
		8 Ω/BRIDGED		1500 W	1500 W	1500 W
	20 –20 kHz THD+N= 0.1 %	8 Ω/STEREO		500 W+500 W	500 W+500 W	500 W+500 W
		4 Ω/STEREO		700 W+700 W	700 W+700 W	700 W+700 W
		8 Ω/BRIDGED		1400 W	1400 W	1400 W
	1 kHz 20mS nonclip	2 Ω/STEREO		1300 W+1300 W	1300 W+1300 W	1300 W+1300 W
		4 Ω/BRIDGED		2600 W	2600 W	2600 W
SN Ratio	20Hz-20kHz	(DIN AUDIO)	MIN	103 dB		
Power Consumption	Standby / idle			5 W / 35 W		
	1/8 (4 Ω/Pink noise)			500 W	500 W	500 W
XP3500				120 V	230 V	240 V
Output Power	1 kHz THD+N= 1 %	8 Ω/STEREO	MIN	390 W+390 W	390 W+390 W	390 W+390 W
		4 Ω/STEREO		590 W+590 W	590 W+590 W	590 W+590 W
		8 Ω/BRIDGED		1180 W	1180 W	1180 W
	20 –20 kHz THD+N= 0.1 %	8 Ω/STEREO		350 W+350 W	350 W+350 W	350 W+350 W
		4 Ω/STEREO		450 W+450 W	435 W+435 W	450 W+450 W
		8 Ω/BRIDGED		900 W	870 W	900 W
	1 kHz 20mS nonclip	100 V/BRIDGED RL=16 Ω		625 W	625 W	625 W
		2 Ω/STEREO		1000 W+1000 W	925 W+925 W	1000 W+1000 W
	4 Ω/BRIDGED	2000 W	1850 W	2000 W		
SN Ratio	20Hz-20kHz	(DIN AUDIO)	MIN	102 dB		
Power Consumption	Standby / idle			5 W / 30		
	1/8 (4 Ω/Pink noise)			450 W	450 W	450 W
XP2500				120 V	230 V	240 V
Output Power	1 kHz THD+N= 1 %	8 Ω/STEREO	MIN	275 W+275 W	275 W+275 W	275 W+275 W
		4 Ω/STEREO		390 W+390 W	390 W+390 W	390 W+390 W
		8 Ω/BRIDGED		780 W	780 W	780 W
	20 –20 kHz THD+N= 0.1 %	8 Ω/STEREO		250 W+250 W	250 W+250 W	250 W+250 W
		4 Ω/STEREO		300 W+300 W	295 W+295 W	300 W+300 W
		8 Ω/BRIDGED		600 W	590 W	600 W
	1 kHz 20mS nonclip	2 Ω/STEREO		650 W+650 W	650 W+650 W	650 W+650 W
		4 Ω/BRIDGED		1300 W	1300 W	1300 W
SN Ratio	20Hz-20kHz	(DIN AUDIO)	MIN	100 dB		
Power Consumption	Standby / idle			5 W / 25 W		
	1/8 (4 Ω/Pink noise)			320 W	320 W	320 W
XP1000				120 V	230 V	240 V
Output Power	1 kHz THD+N= 1 %	8 Ω/STEREO	MIN	135 W+135 W	125 W+125 W	120 W+120 W
		4 Ω/STEREO		165 W+165 W	155 W+155 W	155 W+155 W
		8 Ω/BRIDGED		330 W	310 W	310 W
	20 –20 kHz THD+N= 0.1 %	8 Ω/STEREO		110 W+110 W	100 W+100 W	100 W+100 W
		4 Ω/STEREO		125 W+125 W	115 W+115 W	110 W+110 W
		8 Ω/BRIDGED		250 W	230 W	220 W
	1 kHz 20mS nonclip	2 Ω/STEREO		250 W+250 W	250 W+250 W	250 W+250 W
		4 Ω/BRIDGED		500 W	500 W	500 W
SN Ratio	20 Hz-20 kHz	(DIN AUDIO)	MIN	96 dB		
Power Consumption	Standby / idle			5 W / 20 W		
	1/8 (4 Ω/Pink noise)			170 W	170 W	170 W

All Models							
Power Bandwidth	Half Power, THD+N= 0.5 %	MIN	10 Hz-40 kHz				
THD+N	20 Hz-20 kHz, Half Power	MAX	0.1 %				
Intermodulation Distortion	60 Hz:7 kHz, 4:1, Half Power	MAX	0.1 %				
Frequency Response	RL=8 Ω, Po=1 W, HPF=OFF 20 Hz-50 kHz	MAX	0 dB				
		TYP	0 dB				
		MIN	-1 dB				
Channel Separation	Half Power, RL=8 Ω, 1 kHz, Att. max, input 600 Ω shunt	MIN	70 dB				
Residual Noise	20 Hz-20 kHz, Att. min, (DIN AUDIO)	MAX	-70 dBu				
Damping Factor	RL=8 Ω, 1 kHz	MIN	350 (XP7000, XP5000), 200 (XP3500, XP2500, XP1000)				
Voltage Gain	Att. max		XP7000	XP5000	XP3500	XP2500	XP1000
		TYP	Selectable from 32 dB or 26 dB (or +4 dBu input sensitivity) by select switch				
		+4 dBu position	35.7 dB	34.2 dB	32.7 dB	31.2 dB	27.2 dB
Input Sensitivity (dBu)	Att. max (Rated Power 8 Ω, 20Hz-20kHz, THD+N = 0.1%)		XP7000	XP5000	XP3500	XP2500	XP1000
		+4 dBu position	+4 dBu	+4 dBu	+4 dBu	+4 dBu	+4 dBu
		26 dB position	+13.7 dBu (120V / 240V) +13.6 dBu (230V)	+12.2 dBu	+10.7 dBu	+9.2 dBu	+5.2 dBu
		32 dB position	+7.7 dBu (120V / 240V) +7.6 dBu (230V)	+6.2 dBu	+4.7 dBu	+3.2 dBu	-0.8 dBu
Maximum Input Voltage		MIN	+22 dBu				
Input Impedance		TYP	20 kΩ (balanced), 10 kΩ (unbalanced)				
Controls	Front Panel	POWER switch (push on/push off)					
		attenuator (31 position) x 2					
	Rear Panel	MODE switch (STEREO/BRIDGED/PARALLEL) x 1					
		HPF switch (20 Hz/55 Hz/OFF 12 dB/oct) x 2					
Connectors	Input	XLR-3-31 type/ch, Euroblock connector (balanced) /ch					
	Output	SPEAKON/ch, 5 way binding post x 1					
	MONITOR/REMOTE	Dsub 15 P x 1					
Indicators	POWER/STANDBY	x 1 (Green/Orange)					
	SIGNAL	x 2 (Green)					
	CLIP/LIMIT	x 2 (Red)					
	PROTECTION/TEMP	x 1 (Red) x 1 (Red) heatsink temp. ≥ 85 °C					
Load Protection	POWER switch on/off mute						
	DC-fault: power supply shutdown/operation not restored automatically. (XP7000, XP5000) output relay off/restored automatically. (XP3500, XP2500, XP1000)						
	Clip limiting : THD ≥ 0.5 %						
Amplifier Protection	Thermal: Cuts the output (heatsink temp. ≥ 90 °C) ; operation not restored automatically. VI limiter (RL ≤ 1 Ω): Limit the output.						
Power Supply Protection	Thermal: Power supply shutdown (heatsink temp. ≥ 100 °C) ; operation not restored automatically. (XP7000, XP5000). power supply shutdown (transformer temp. ≥ 130 °C) ; restored automatically. (XP3500, XP2500, XP1000)						
Cooling	Variable-speed fan: x 1(XP3500, XP2500, XP1000), x 2 (XP7000, XP5000) Fan stop at heatsink temp. < 55 °C						
Power Requirements	120V, 220V-240V; 50Hz/60Hz						
Dimensions (W x H x D)	480 x 88 x 456 mm (18-7/8" x 3-7/16" x 17-15/16")						
Weight	XP7000	XP5000	XP3500	XP2500	XP1000		
	14.0 kg (30.9 lbs)	14.0 kg (30.9 lbs)	15.0 kg (33.1 lbs)	14.0 kg (30.9 lbs)	12 kg (26.5 lbs)		
Included Accessories	Security cover (with a hex wrench), Owner's Manual						

* These specifications apply to rated power supplies of 120V, 230V and 240V.

0 dBu=0.775 Vrms, Half Power=1/2 Output Power (3 dB below rated power)

Specifications and descriptions in this owner's manual are for information purposes only.

Yamaha Corp. reserves the right to change or modify products or specifications at any time without prior notice. Since specifications, equipment or options may not be the same in every locale, please check with your Yamaha dealer.

European models

Purchaser/User Information specified in EN55103-1 and EN55103-2.

Inrush Current: XP7000/5000 25A , XP3500 22A, XP2500 20A, XP1000 14A

Conforms to Environments: E1, E2, E3 and E4

■ MONITOR/REMOTE PIN layout

Pin No.	Signal		Description
1	GND		
2	REMOTE CONTROL	STANDBY	STANDBY Control: Supply 5 VDC, 5 mADC
3	MONITOR	MODEL ID	XP7000: 1.0 k Ω , XP5000: 1.2 k Ω , XP3500: 1.5 k Ω , XP2500: 1.8 k Ω , XP1000: 2.2 k Ω (Impedance to GND)
4	REMOTE CONTROL	NC	
5		NC	
6		MUTE CH B	MUTE On Control: Connect the pin to GND (max. 1mA flows)
7		MUTE CH A	MUTE Off Control: Open the pin (+5V applied)
8	MONITOR	NC	
9		NC	
10		PROTECTION/MUTE STATUS CH B	Protection/Mute On: +5 VDC, Zo=270 Ω
11		PROTECTION/MUTE STATUS CH A	Protection/Mute Off: 0 VDC, Zo=High
12		NC	
13		NC	
14		OUTPUT LEVEL CH B	XP7000, XP5000, XP3500, XP2500, XP1000
15	OUTPUT LEVEL CH A	+4dBu (-27.2 dB of Speaker Output Level) at 100 W/8 Ω , RL=7.5 k Ω , Zo=300 Ω	

■ Dimensions

Unit: mm

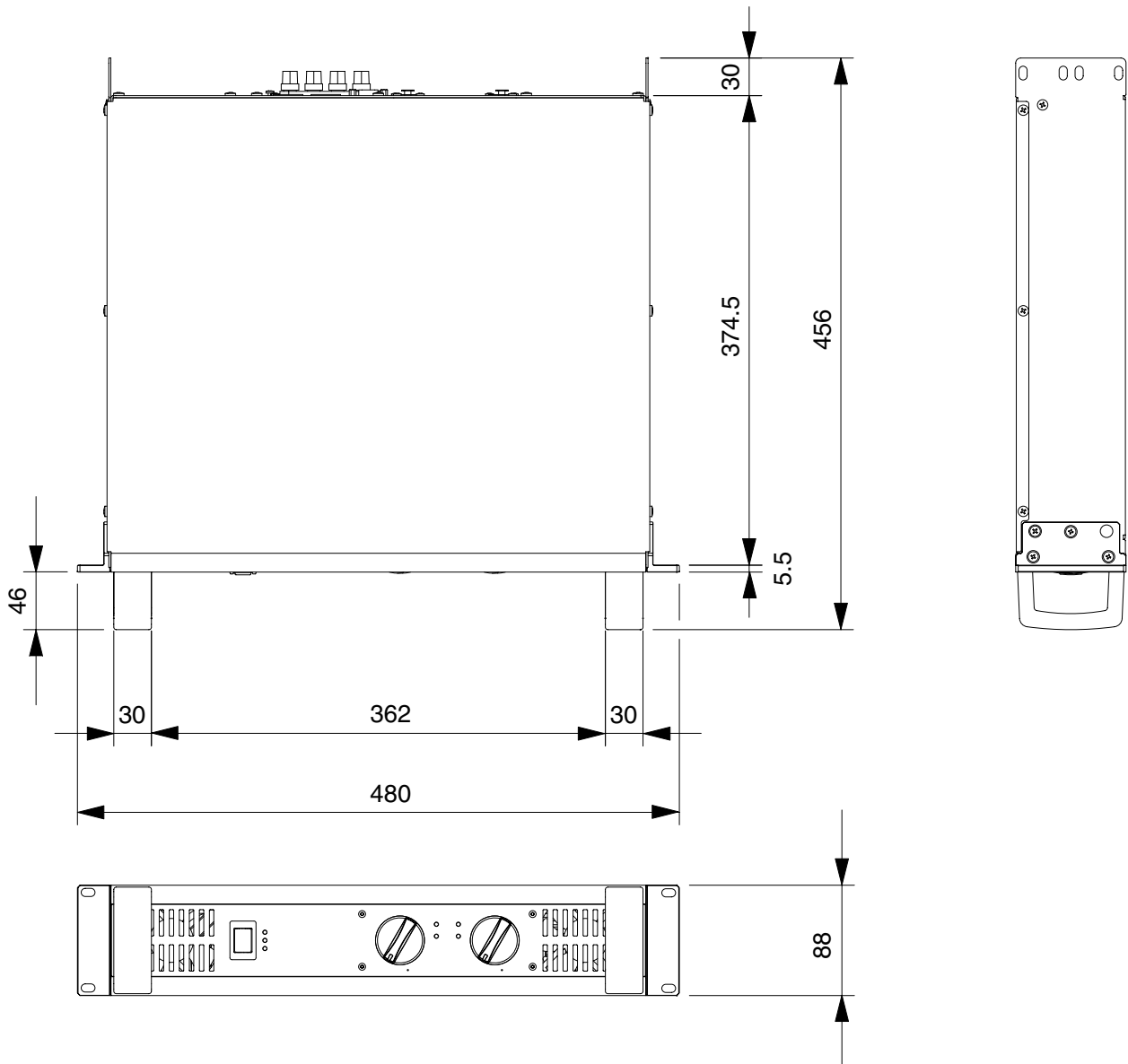

■ Block Diagram

● XP7000/XP5000

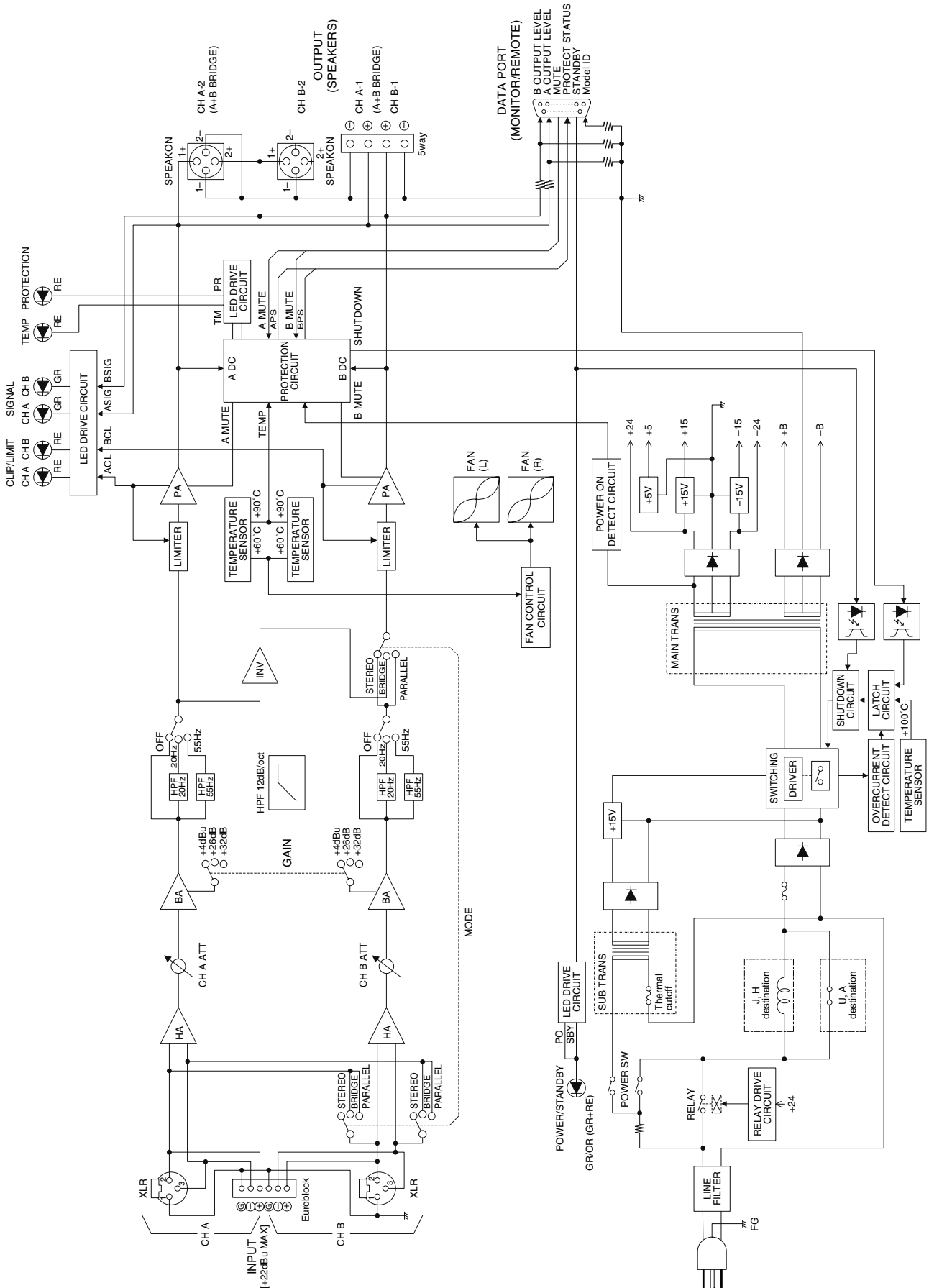

● XP3500/XP2500/XP1000

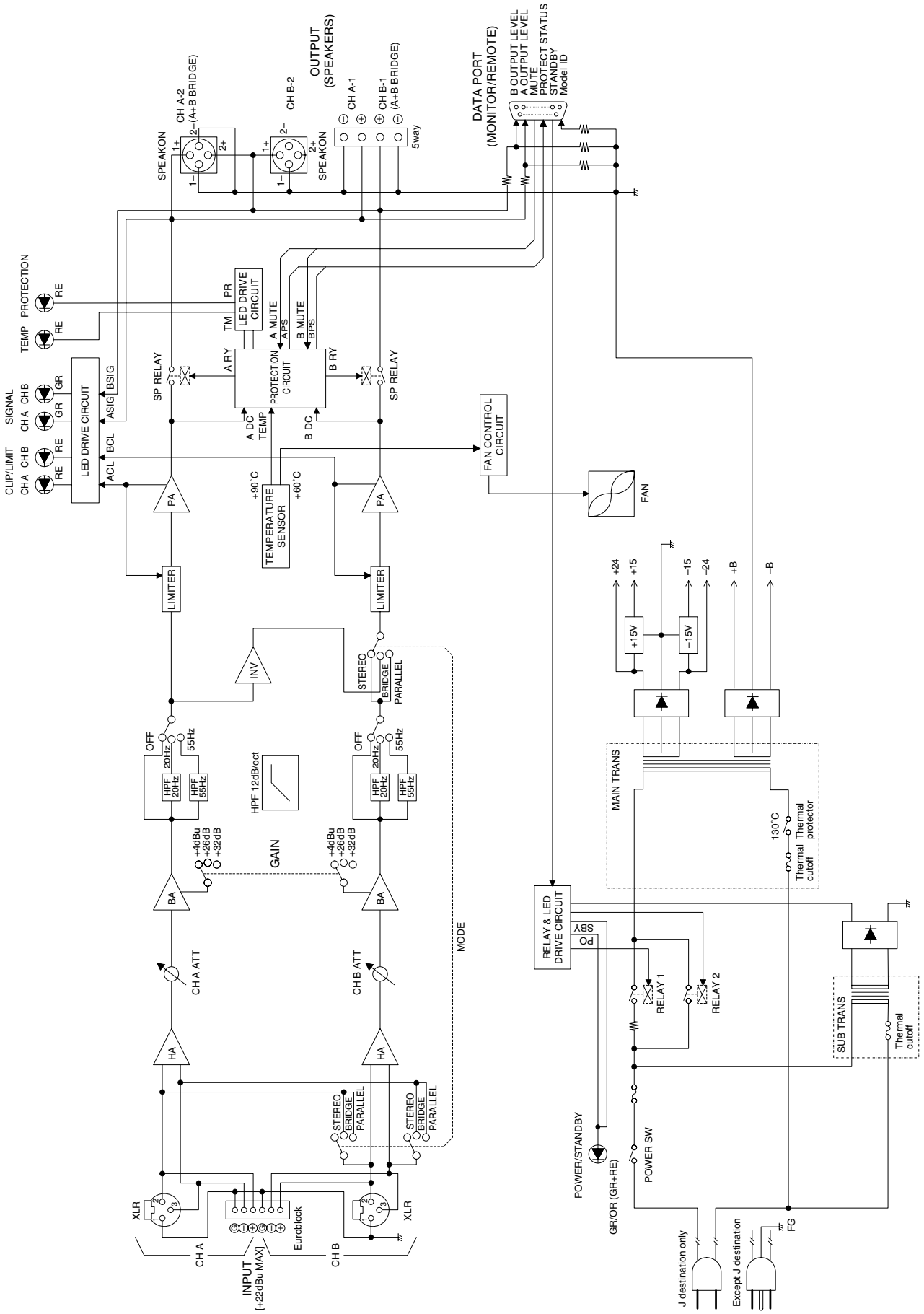

■ Current Draw

XP7000

		Line Current (A)		Power (W)			Thermal Dissipation	
		100/120V	230/240V	In	Out	Dissipated	Btu/h	kcal/h
standby		0.08	0.04	5	0	5	17	4
idle		1.0	0.5	35	0	35	119	30
1/8 power	8Ω/ch	5.4	3.0	379	188	191	653	165
	4Ω/ch	8.5	4.7	611	275	336	1150	289
1/3 power	8Ω/ch	12.8	7.0	918	500	418	1430	360
	4Ω/ch	20.6	11.3	1481	733	748	2550	643

XP5000

		Line Current (A)		Power (W)			Thermal Dissipation	
		100/120V	230/240V	In	Out	Dissipated	Btu/h	kcal/h
standby		0.08	0.04	5	0	5	17	4
idle		1.0	0.5	35	0	35	119	30
1/8 power	8Ω/ch	4.0	2.2	277	131	146	499	126
	4Ω/ch	6.2	3.4	436	188	249	848	214
1/3 power	8Ω/ch	9.3	5.1	673	350	323	1100	278
	4Ω/ch	14.7	8.1	1057	500	557	1900	479

XP3500

		Line Current (A)		Power (W)			Thermal Dissipation	
		100/120V	230/240V	In	Out	Dissipated	Btu/h	kcal/h
standby		0.08	0.04	5	0	5	17	4
idle		1.0	0.5	30	0	30	102	26
1/8 power	8Ω/ch	3.2	1.7	227	98	130	443	112
	4Ω/ch	5.0	2.8	378	148	231	787	198
1/3 power	8Ω/ch	7.3	4.0	551	260	291	993	250
	4Ω/ch	12.2	6.7	917	393	524	1790	450

XP2500

		Line Current (A)		Power (W)			Thermal Dissipation	
		100/120V	230/240V	In	Out	Dissipated	Btu/h	kcal/h
standby		0.08	0.04	5	0	5	17	4
idle		1.0	0.5	25	0	25	85	22
1/8 power	8Ω/ch	2.4	1.3	174	69	105	358	90
	4Ω/ch	3.6	2.0	271	98	173	592	149
1/3 power	8Ω/ch	5.6	3.1	421	183	238	811	204
	4Ω/ch	8.8	4.8	657	260	397	1350	341

XP1000

		Line Current (A)		Power (W)			Thermal Dissipation	
		100/120V	230/240V	In	Out	Dissipated	Btu/h	kcal/h
standby		0.08	0.04	5	0	5	17	4
idle		1.0	0.5	20	0	20	68	17
1/8 power	8Ω/ch	1.1	0.6	76	28	48	165	42
	4Ω/ch	1.2	0.7	91	30	61	208	52
1/3 power	8Ω/ch	2.4	1.3	184	73	110	376	95
	4Ω/ch	2.9	1.6	220	80	140	479	121

1/8 power is typical of program material with occasional clipping. Refer to these figures for most applications.

1/3 power represents program material with extremely heavy clipping.

Test signal: Pink Noise, bandwidth limited from 22Hz to 22kHz

1W = 0.860kcal/h, 1BTU = 0.252kcal

Note that Line Voltage [V] x Line Current [A] = [VA], not equals to [W].

Inrush current

XP7000, XP5000: 11A (100V), 13A (120V), 25A (240V)

XP3500: 11A (100V), 13A (120V), 22A (240V)

XP2500: 10A (100V), 12A (120V), 20A (240V)

XP1000: 9A (100V), 11A (120V), 14A (240V)

For details of products, please contact your nearest Yamaha representative or the authorized distributor listed below.

Pour plus de détails sur les produits, veuillez-vous adresser à Yamaha ou au distributeur le plus proche de vous figurant dans la liste suivante.

Die Einzelheiten zu Produkten sind bei Ihrer unten aufgeführten Niederlassung und bei Yamaha Vertragshändlern in den jeweiligen Bestimmungsländern erhältlich.

Para detalles sobre productos, contacte su tienda Yamaha más cercana o el distribuidor autorizado que se lista debajo.

NORTH AMERICA

CANADA

Yamaha Canada Music Ltd.
135 Milner Avenue, Scarborough, Ontario,
M1S 3R1, Canada
Tel: 416-298-1311

U.S.A.

Yamaha Corporation of America
6600 Orangethorpe Ave., Buena Park, Calif. 90620,
U.S.A.
Tel: 714-522-9011

CENTRAL & SOUTH AMERICA

MEXICO

Yamaha De México, S.A. de C.V.
Av. Insurgentes Sur 1647 "Prisma Insurgentes",
Col. San José Insurgentes, Del. Benito Juárez,
03900, México, D.F.
Tel: 55-5804-0600

BRAZIL

Yamaha Musical do Brasil Ltda.
Rua Joaquim Floriano, 913 - 4º andar, Itaim Bibi,
CEP 04534-013 Sao Paulo, SP. BRAZIL
Tel: 011-3704-1377

ARGENTINA

Yamaha Music Latin America, S.A.
Sucursal de Argentina
Olga Cossettini 1553, Piso 4 Norte
Madero Este-C1107CEK
Buenos Aires, Argentina
Tel: 011-4119-7000

PANAMA AND OTHER LATIN AMERICAN COUNTRIES/ CARIBBEAN COUNTRIES

Yamaha Music Latin America, S.A.
Torre Banco General, Piso 7, Urbanización Marbella,
Calle 47 y Aquilino de la Guardia,
Ciudad de Panamá, Panamá
Tel: +507-269-5311

EUROPE

THE UNITED KINGDOM/IRELAND

Yamaha Music Europe GmbH (UK)
Sherbourne Drive, Tilbrook, Milton Keynes,
MK7 8BL, England
Tel: 01908-366700

GERMANY

Yamaha Music Europe GmbH
Siemensstraße 22-34, 25462 Rellingen, Germany
Tel: 04101-3030

SWITZERLAND/LIECHTENSTEIN

Yamaha Music Europe GmbH
Branch Switzerland in Zürich
Seefeldstrasse 94, 8008 Zürich, Switzerland
Tel: 044-387-8080

AUSTRIA/BULGARIA

Yamaha Music Europe GmbH Branch Austria
Schleiergasse 20, A-1100 Wien, Austria
Tel: 01-60203900

CZECH REPUBLIC/HUNGARY/ ROMANIA/SLOVAKIA/SLOVENIA

Yamaha Music Europe GmbH
Branch Austria (Central Eastern Europe Office)
Schleiergasse 20, A-1100 Wien, Austria
Tel: 01-602039025

POLAND/LITHUANIA/LATVIA/ESTONIA

Yamaha Music Europe GmbH
Branch Poland Office
ul. Wrotkowa 14 02-553 Warsaw, Poland
Tel: 022-500-2925

MALTA

Olimpus Music Ltd.
The Emporium, Level 3, St. Louis Street Msida
MSD06
Tel: 02133-2144

THE NETHERLANDS/ BELGIUM/LUXEMBOURG

Yamaha Music Europe Branch Benelux
Clarissenhof 5-b, 4133 AB Vianen, The Netherlands
Tel: 0347-358 040

FRANCE

Yamaha Music Europe
7 rue Ambroise Croizat, Zone d'activités Pariest,
77183 Croissy-Beaubourg, France
Tel: 01-64-61-4000

ITALY

Yamaha Music Europe GmbH, Branch Italy
Viale Italia 88, 20020 Lainate (Milano), Italy
Tel: 02-935-771

SPAIN/PORTUGAL

Yamaha Music Europe GmbH Ibérica, Sucursal en España
Ctra. de la Coruna km. 17, 200, 28230
Las Rozas (Madrid), Spain
Tel: +34-902-39-8888

GREECE

Philippos Nakas S.A. The Music House
147 Skiathou Street, 112-55 Athens, Greece
Tel: 01-228 2160

SWEDEN/FINLAND/ICELAND

Yamaha Music Europe GmbH Germany filial Scandinavia
J. A. Wettergrens Gata 1, Box 30053
S-400 43 Göteborg, Sweden
Tel: 031 89 34 00

DENMARK

Yamaha Music Europe GmbH, Tyskland – filial Denmark
Generatorvej 6A, DK-2730 Herlev, Denmark
Tel: 44 92 49 00

NORWAY

Yamaha Music Europe GmbH Germany - Norwegian Branch
Grini Næringspark 1, N-1345 Østerås, Norway
Tel: 67 16 77 70

RUSSIA

Yamaha Music (Russia)
Room 37, bld. 7, Kievskaya street, Moscow,
121059, Russia
Tel: 495 626 5005

OTHER EUROPEAN COUNTRIES

Yamaha Music Europe GmbH
Siemensstraße 22-34, 25462 Rellingen, Germany
Tel: +49-4101-3030

AFRICA

Yamaha Corporation,
Asia-Pacific Sales & Marketing Group
Nakazawa-cho 10-1, Naka-ku, Hamamatsu,
Japan 430-8650
Tel: +81-53-460-2303

MIDDLE EAST

TURKEY

Yamaha Music Europe GmbH
Merkezi Almanya Türkiye İstanbul Şubesi
Maslak Meydan Sokak No:5 Spring Giz Plaza
Bağimsız Bol. No:3, 34398 Şişli İstanbul
Tel: +90-212-999-8010

CYPRUS

Yamaha Music Europe GmbH
Siemensstraße 22-34, 25462 Rellingen, Germany
Tel: 04101-3030

OTHER COUNTRIES

Yamaha Music Gulf FZE
LOB 16-513, P.O.Box 17328, Jubel Ali,
Dubai, United Arab Emirates
Tel: +971-4-881-5868

ASIA

THE PEOPLE'S REPUBLIC OF CHINA

Yamaha Music & Electronics (China) Co., Ltd.
2F, Yunhedasha, 1818 Xinzha-lu, Jingan-qu,
Shanghai, China
Tel: 021-6247-2211

INDIA

Yamaha Music India Pvt. Ltd.
Spazedge building, Ground Floor, Tower A, Sector
47, Gurgaon- Sohna Road, Gurgaon, Haryana, India
Tel: 0124-485-3300

INDONESIA

PT. Yamaha Musik Indonesia (Distributor)

PT. Nusantik

Gedung Yamaha Music Center, Jalan Jend. Gatot
Subroto Kav. 4, Jakarta 12930, Indonesia
Tel: 021-520-2577

KOREA

Yamaha Music Korea Ltd.
8F, 9F, Dongsung Bldg. 158-9 Samsung-Dong,
Kangnam-Gu, Seoul, Korea
Tel: 02-3467-3300

MALAYSIA

Yamaha Music (Malaysia) Sdn., Bhd.
Lot 8, Jalan Perbandaran, 47301 Kelana Jaya,
Petaling Jaya, Selangor, Malaysia
Tel: 03-78030900

SINGAPORE

Yamaha Music (Asia) PRIVATE LIMITED
Blk 202 Hougang Street 21, #02-00,
Singapore 530202, Singapore
Tel: 6747-4374

TAIWAN

Yamaha KHS Music Co., Ltd.
3F, #6, Sec.2, Nan Jing E. Rd. Taipei.
Taiwan 104, R.O.C.
Tel: 02-2511-8688

THAILAND

Siam Music Yamaha Co., Ltd.
4, 6, 15 and 16th floor, Siam Motors Building,
891/1 Rama 1 Road, Wangmai,
Pathumwan, Bangkok 10330, Thailand
Tel: 02-215-2622

VIETNAM

Yamaha Music Vietnam Company Limited
15th Floor, Nam A Bank Tower, 201-203 Cach
Mang Thang Tam St., Ward 4, Dist.3,
Ho Chi Minh City, Vietnam
Tel: +84-8-3818-1122

OTHER ASIAN COUNTRIES

Yamaha Corporation,
Asia-Pacific Sales & Marketing Group
Nakazawa-cho 10-1, Naka-ku, Hamamatsu,
Japan 430-8650
Tel: +81-53-460-2303

OCEANIA

AUSTRALIA

Yamaha Music Australia Pty. Ltd.
Level 1, 99 Queensbridge Street, Southbank,
Victoria 3006, Australia
Tel: 3-9693-5111

COUNTRIES AND TRUST TERRITORIES IN PACIFIC OCEAN

Yamaha Corporation,
Asia-Pacific Sales & Marketing Group
Nakazawa-cho 10-1, Naka-ku, Hamamatsu,
Japan 430-8650
Tel: +81-53-460-2303



Yamaha Pro Audio global web site:
<http://www.yamahaproaudio.com/>

Yamaha Manual Library:
<http://www.yamaha.co.jp/manual/>

C.S.G., Pro Audio Division
© 2005 Yamaha Corporation

305POAPx.x-01E0
Printed in Vietnam

WF37200