



KRAMER ELECTRONICS LTD.

USER MANUAL

MODELS:

TP-580T_{xr}

HDMI Line Transmitter

TP-580R_{xr}

HDMI Line Receiver

P/N: 2900-300088 Rev 5



TP-580Txr, TP-580Rxr Quick Start Guide

This guide helps you install and use your products for the first time. For more detailed information, go to <http://www.kramerav.com/manual/TP-580Txr> to download the latest manual or scan the QR code on the left.

Step 1: Check what's in the box

- The **TP-580Txr** HDMI Line Transmitter and/or the **TP-580Rxr** HDMI Line Receiver
- 2 power adapters (12V DC)
- Mounting brackets
- 8 Rubber feet
- 1 Quick start guide

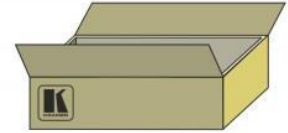

Save the original box and packaging materials in case you need to return your product for service.

Step 2: Install the TP-580Txr and TP-580Rxr

Mount the units in a rack or place them on a table.

Step 3: Connect inputs and outputs

Always switch OFF the power on each device before connecting it to your Transmitter/Receiver.

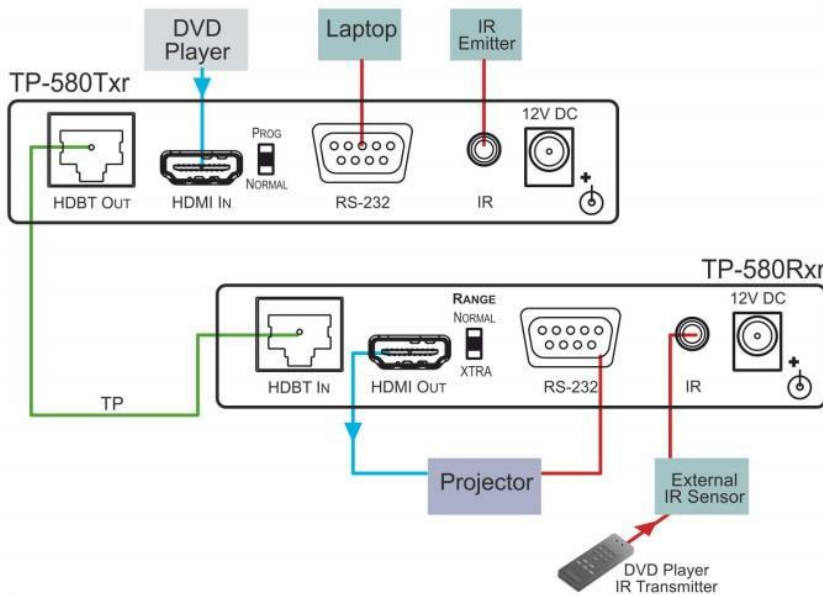

Twisted Pair Pinout

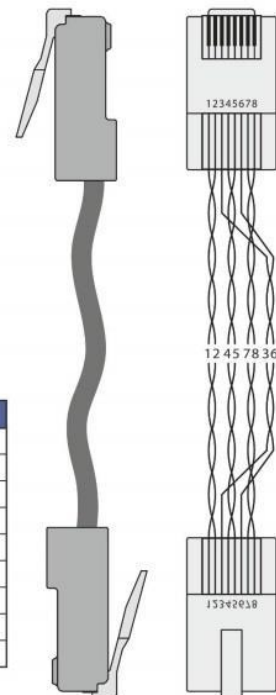

For best results, we recommend that you always use Kramer high-performance cables to connect AV equipment to the **TP-580Txr** and **TP-580Rxr**. For optimum range and performance use Kramer's **BC-HDKat6a** cable. Note that the transmission range depends on the signal resolution, graphics card and display used. The distance using non-Kramer CAT 6 cable may not reach these ranges. Use only shielded cable where both ends of the shield are soldered to ground.

EIA / TIA 568B	
PIN	Wire Color
1	Orange / White
2	Orange
3	Green / White
4	Blue
5	Blue / White
6	Green
7	Brown / White
8	Brown

Step 4: Connect the power

Connect the power adapters to the **TP-580Txr** and/or **TP-580Rxr** and plug the adapter/s into the mains electricity.

Contents

1	Introduction	1
2	Getting Started	2
2.1	Achieving the Best Performance	2
2.2	Safety Instructions	2
2.3	Recycling Kramer Products	3
3	Overview	4
3.1	About HDBaseT™ Technology	5
3.2	Using Twisted Pair Cable	5
4	Defining the TP-580Txr HDMI Line Transmitter	6
5	Defining the TP-580Rxr HDMI Line Receiver	7
6	Connecting the TP-580Txr / TP-580Rxr Transmitter / Receiver	8
6.1	Controlling the A/V Equipment via an IR Transmitter	10
6.2	Connecting to a PC	12
6.3	Wiring the TP LINE IN / LINE OUT RJ-45 Connectors	13
7	Technical Specifications	14

Figures

Figure 1:	TP-580Txr HDMI Line Transmitter	6
Figure 2:	TP-580Rxr HDMI Line Receiver	7
Figure 3:	Connecting the TP-580Txr/TP-580Rxr Transmitter/Receiver	9
Figure 4:	Controlling a DVD Player via the TP-580Rxr	10
Figure 5:	Controlling an LCD Display via the TP-580Txr	11
Figure 6:	RS-232 Control	12
Figure 7:	TP PINOUT	13

1 Introduction

Welcome to Kramer Electronics! Since 1981, Kramer Electronics has been providing a world of unique, creative, and affordable solutions to the vast range of problems that confront video, audio, presentation, and broadcasting professionals on a daily basis. In recent years, we have redesigned and upgraded most of our line, making the best even better!

Our 1,000-plus different models now appear in 14 groups that are clearly defined by function: GROUP 1: Distribution Amplifiers; GROUP 2: Switchers and Routers; GROUP 3: Control Systems; GROUP 4: Format/Standards Converters; GROUP 5: Range Extenders and Repeaters; GROUP 6: Specialty AV Products; GROUP 7: Scan Converters and Scalers; GROUP 8: Cables and Connectors; GROUP 9: Room Connectivity; GROUP 10: Accessories and Rack Adapters; GROUP 11: Sierra Video Products; GROUP 12: Digital Signage; GROUP 13: Audio; and GROUP 14: Collaboration.

Congratulations on purchasing your Kramer **TP-580Txr** transmitter and/or **TP-580Rxr** receiver, which can be part of a transmitter/receiver system and are ideal for the following typical applications:

- Conference rooms, boardrooms, auditoriums, hotels, churches, classrooms and production studios
- Rental and staging



Note that **TP-580Txr** and **TP-580Rxr** are purchased separately, and can be connected to other HDBaseT certified transmitters and receivers, respectively.

2 Getting Started

We recommend that you:

- Unpack the equipment carefully and save the original box and packaging materials for possible future shipment
- Review the contents of this user manual



Go to <http://www.kramerav.com/manual/TP-590TXR> to check for up-to-date user manuals, application programs, and to check if firmware upgrades are available (where appropriate).

2.1 Achieving the Best Performance

To achieve the best performance:

- Use only good quality connection cables (we recommend Kramer high-performance, high-resolution cables) to avoid interference, deterioration in signal quality due to poor matching, and elevated noise levels (often associated with low quality cables)
- Do not secure the cables in tight bundles or roll the slack into tight coils
- Avoid interference from neighboring electrical appliances that may adversely influence signal quality
- Position your Kramer **TP-580Txr** and **TP-580Rxr** transmitter/receiver pair away from moisture, excessive sunlight and dust



This equipment is to be used only inside a building. It may only be connected to other equipment that is installed inside a building.

2.2 Safety Instructions



Caution: There are no operator serviceable parts inside the unit

Warning: Use only the Kramer Electronics input power wall adapter that is provided with the unit

Warning: Disconnect the power and unplug the unit from the wall before installing

2.3 Recycling Kramer Products

The Waste Electrical and Electronic Equipment (WEEE) Directive 2002/96/EC aims to reduce the amount of WEEE sent for disposal to landfill or incineration by requiring it to be collected and recycled. To comply with the WEEE Directive, Kramer Electronics has made arrangements with the European Advanced Recycling Network (EARN) and will cover any costs of treatment, recycling and recovery of waste Kramer Electronics branded equipment on arrival at the EARN facility. For details of Kramer's recycling arrangements in your particular country go to our recycling pages at <http://www.kramerav.com/support/recycling/>.

3 Overview

The **TP-580Txr** and **TP-580Rxr** are a high-performance, extra range, HDBaseT technology Twisted Pair transmitter and receiver for HDMI, bidirectional RS-232 and IR signals. The **TP-580Txr** converts the HDMI signal, RS-232 and IR input signals to a twisted pair signal. The **TP-580Rxr** converts the twisted pair signal back into HDMI, RS-232, and IR signals.

The **TP-580Txr** and **TP-580Rxr** can together form an extended HDMI/data line transmission and reception system or can separately connect to other certified HDBaseT devices to form the transmission and reception system. For example, the transmitter and receiver system can be composed of **WP-580Txr** that connects to the Kramer **TP-580Rxr** to form a transmitter / receiver pair.

The **TP-580Txr** and **TP-580Rxr** transmitter/receiver feature:

- A bandwidth of up to 10.2Gbps (3.4Gbps per graphic channel) in normal mode; up to 4.95Gbps (1.65Gbps per graphic channel) in ultra-mode
- System Range - Up to 130m (430ft) at normal mode (2K), up to 100m at normal mode (4K); up to 180m (590ft) ultra mode (1080p @60Hz @24bpp) when using **BC-HDKat6a** cables



For optimum range and performance using HDBaseT™, use Kramer's **BC-HDKat6a** cable. Note that the transmission range depends on the signal resolution, source and display used. The distance using non-Kramer CAT 6 cable may not reach these ranges.

- 2K and 4K support in normal mode
- HDBaseT™ technology
- HDTV compatibility and HDCP compliance
- HDMI support - HDMI (deep color, x.v.Color™, lip sync, HDMI uncompressed audio channels, Dolby TrueHD, DTS-HD, CEC, 2K, 4K, 3D)
- EDID pass through, passes EDID signals from the source to the display
- Bidirectional RS-232 interface - commands and data can flow in both directions via the RS-232 interface, allowing status requests and control of the destination unit

- Bidirectional infrared interface for remote control of peripheral devices (see [Section 6.1](#))
- LED status indicators for input, output, link and power
- Compact DigiTOOLS® enclosures, and these can be rack mounted side-by-side in a 1U rack space with the optional **RK-3T**, **RK-6T** or **RK-9T** universal rack adapters

3.1 About HDBaseT™ Technology

HDBaseT™ is an advanced all-in-one connectivity technology (Supported by the HDBaseT Alliance). It is particularly suitable in the consumer home environment as a digital home networking alternative where it enables you to replace numerous cables and connectors by a single LAN cable used to transmit, for example, uncompressed full high-definition video, audio, IR, as well as various control signals.



The products described in this user manual are HDBaseT certified.

3.2 Using Twisted Pair Cable

Kramer engineers have developed special twisted pair cables to best match our digital twisted pair products; **BC-HDKat6a** (CAT 6 23 AWG cable) significantly outperforms regular CAT 5 / CAT 6 cables.



We strongly recommend that you use shielded twisted pair cable.

4 Defining the TP-580Txr HDMI Line Transmitter

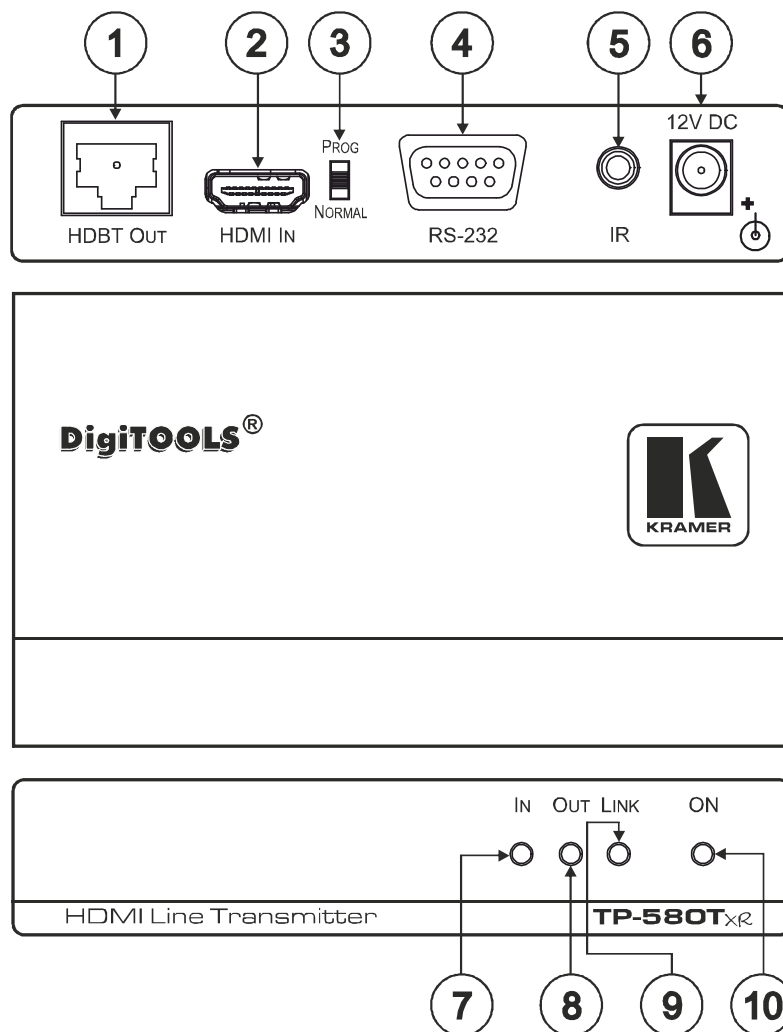

Figure 1: TP-580Txr HDMI Line Transmitter

#	Feature	Function
1	<i>HDBT OUT</i> RJ-45 Connector	Connects to the <i>HDBT IN</i> RJ-45 connector on the TP-580Rxr
2	<i>HDMI IN</i> Connector	Connects to the HDMI source
3	<i>PROG/NORMAL</i> Switch	Slide to <i>PROG</i> to upgrade to the latest Kramer firmware via RS-232, or slide to <i>NORMAL</i> for normal operation
4	<i>RS-232</i> 9-pin D-sub Connector	Connects to an RS-232 port for firmware upgrade and control of the destination unit
5	<i>IR</i> 3.5mm Mini Jack Connector	Connects to an external infrared transmitter / sensor (receiver)
6	<i>12V DC</i>	+12V DC connector for powering the unit
7	<i>IN</i> LED	Lights green when an HDMI input device is connected
8	<i>OUT</i> LED	Lights green when an HDMI output device is detected
9	<i>LINK</i> LED	Lights green when the TP connection is active
10	<i>ON</i> LED	Lights when receiving power

5 Defining the TP-580Rxr HDMI Line Receiver

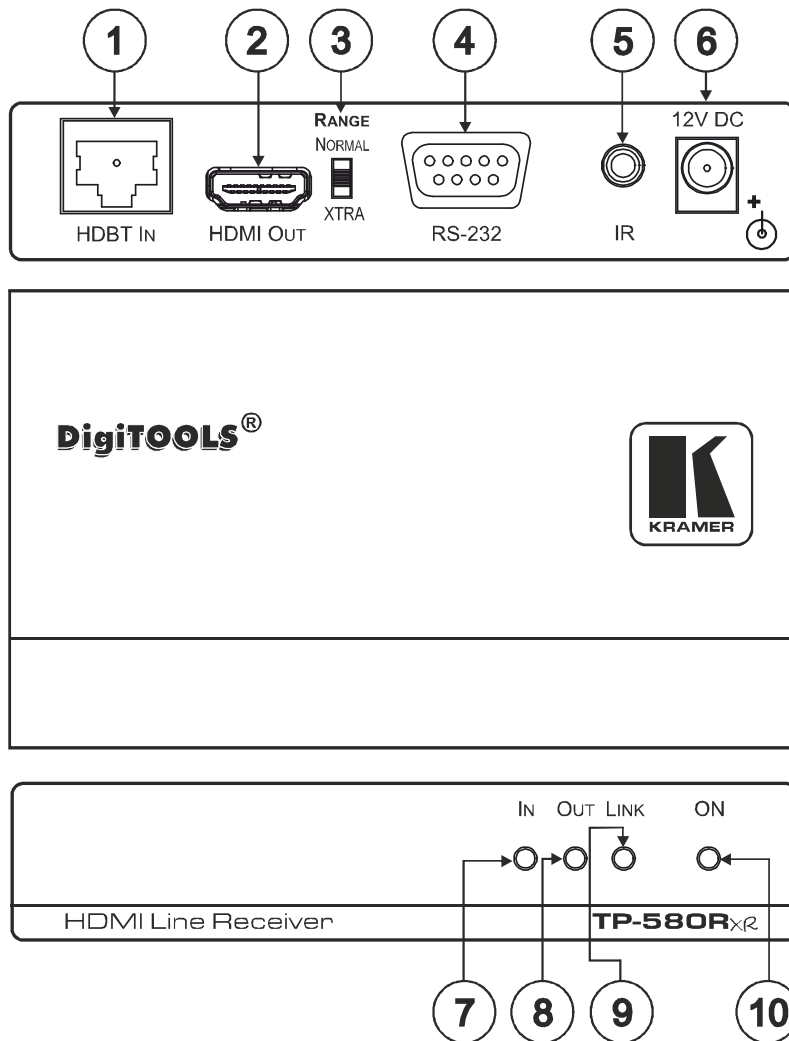

Figure 2: TP-580Rxr HDMI Line Receiver

#	Feature	Function
1	HDBT IN RJ-45 Connector	Connects to the HDBT OUT RJ-45 connector on the TP-580Txr
2	HDMI OUT Connector	Connects to the HDMI acceptor
3	NORMAL/XTRA RANGE Slide Switch	Slide to NORMAL for distances of up to 100 meter at 1080p@60Hz@36bpp Slide to XTRA for distances of up to 150 meters at 1080p@60Hz@24bpp
4	RS-232 9-pin D-sub Connector	Connects to an RS-232 port for firmware upgrade and control of the destination unit
5	IR 3.5mm Mini Jack Connector	Connects to an external infrared transmitter / sensor (receiver)
6	12V DC	+12V DC connector for powering the unit
7	IN LED	Lights green when an HDMI input device is connected
8	OUT LED	Lights green when an HDMI output device is detected
9	LINK LED	Lights green when the TP connection is active
10	ON LED	Lights green when receiving power

6 Connecting the TP-580Txr / TP-580Rxr Transmitter / Receiver



Always switch off the power to each device before connecting it to your Transmitter and Receiver. After connecting your Transmitter and Receiver, connect their power and then switch on the power to each device.

You can use the **TP-580Txr HDMI Line Transmitter** and the **TP-580Rxr HDMI Line Receiver** to configure an HDMI transmitter/receiver system, as shown in the example in [Figure 3](#).

To connect the **TP-580Txr**, connect the:

1. HDMI source (for example, a DVD player) to the HDMI IN connector.
2. RS-232 9-pin D-sub connector to a computer (for example, a laptop to control the projector).
3. External IR transmitter from the 3.5mm mini jack to an IR Receiver on the DVD player, for example.
4. *HDBT OUT* RJ-45 connector over twisted pair to the **TP-580Rxr HDBT IN** connector.

Alternatively, you can use any other certified HDBaseT receiver device (for example, the Kramer **WP-580Rxr**)

5. 12V DC power adapter to the power socket and connect the adapter to the mains electricity (not shown in [Figure 3](#)).

To connect the **TP-580Rxr**, connect the:

6. HDMI OUT connector to the HDMI acceptor (for example, a projector).
7. RS-232 9-pin D-sub connector to an RS-232 port (for example, a projector that is controlled by the laptop that is connected to **TP-580Txr**).
8. IR 3.5mm mini jack to an IR sensor.
9. *HDBT IN* RJ-45 connector over twisted pair to the **TP-580Txr HDBT OUT** connector.

Alternatively, you can use any other certified HDBaseT transmitter device (for example, the Kramer **WP-580Txr**)

10. 12V DC power adapter to the power socket and connect the adapter to the mains electricity (not shown in [Figure 3](#)).

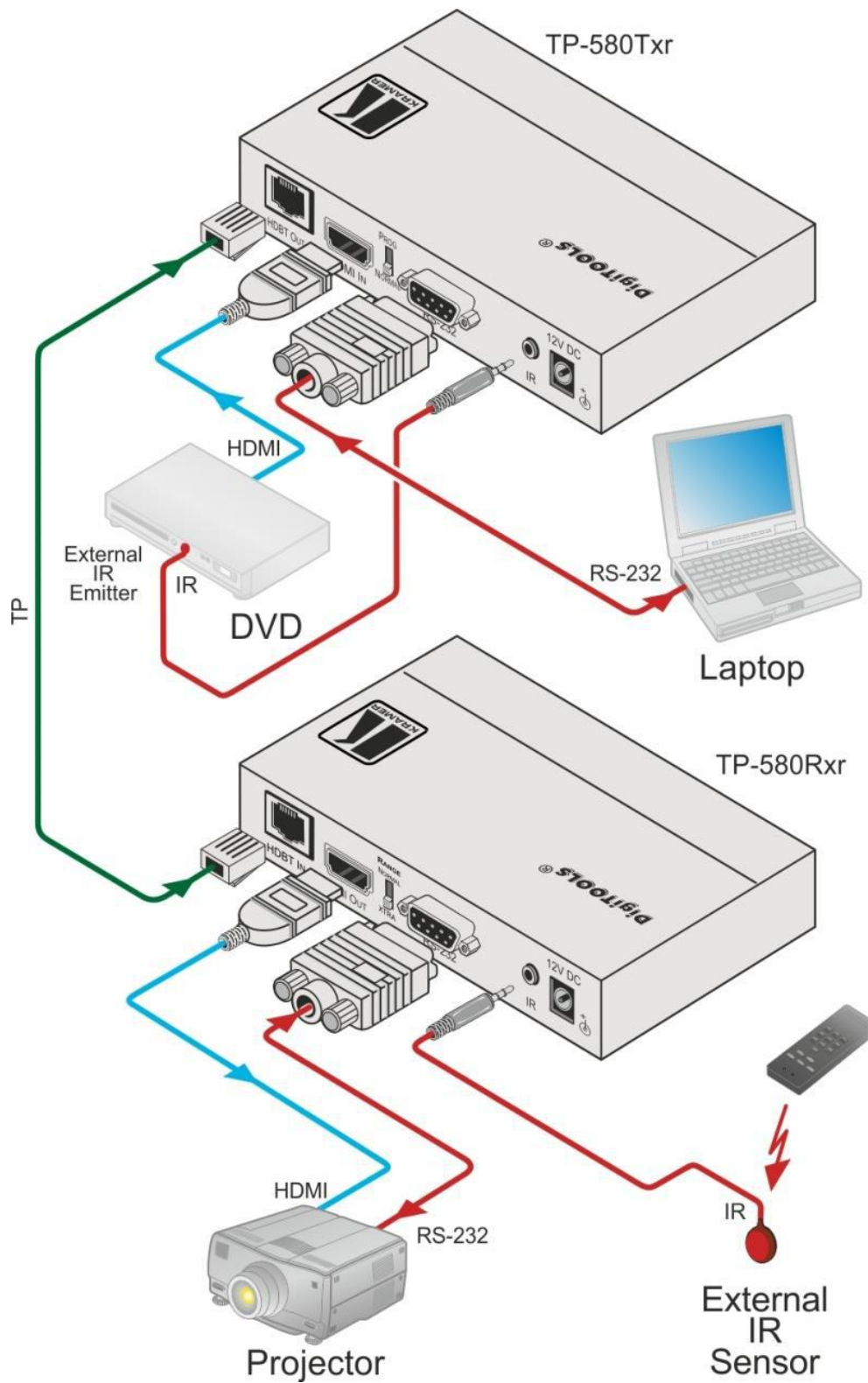

Figure 3: Connecting the TP-580Txr/TP-580Rxr Transmitter/Receiver

6.1 Controlling the A/V Equipment via an IR Transmitter

Since the IR signal on the **TP-580Txr** transmitter and **TP-580Rxr** receiver is bidirectional, you can use a remote control transmitter (that is used for controlling a peripheral device, for example, a DVD player) to send commands (to the A/V equipment) from either end of the transmitter /receiver system. To do so, you have to use the Kramer external IR sensor on one end (P/N: 95-0104050) and the Kramer IR emitter cable on the other end (P/N: C-A35/IRE-10)

Two IR Emitter Extension Cables are also available: a 15 meter cable and a 20 meter cable.

The example in [Figure 4](#) illustrates how to control the DVD player that is connected to **TP-580Txr** using a remote control, via the **TP-580Rxr**. In this example, the External IR Sensor is connected to the IR connector of the **TP-580Rxr** and an IR Emitter is connected between the **TP-580Txr** and the DVD player. The DVD remote control sends a command while pointing towards the External IR Sensor. The IR signal passes through the TP cable and the IR Emitter to the DVD player, which responds to the command sent.

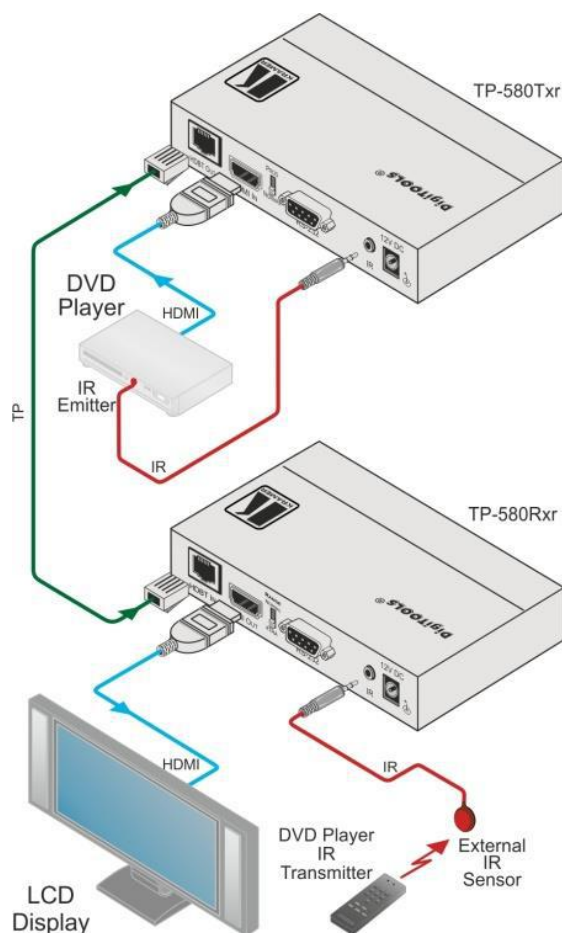

Figure 4: Controlling a DVD Player via the TP-580Rxr

The example in [Figure 5](#) illustrates how to control the LCD display that is connected to **TP-580Rxr** using a remote control, via the **TP-580Txr**. In this example, the External IR Sensor is connected to the IR connector of the **TP-580Txr** and an IR Emitter is connected between the **TP-580Rxr** and the LCD display. The LCD display remote control sends a command while pointing towards the External IR Sensor. The IR signal passes through the TP cable and the IR Emitter to the LCD display, which responds to the command sent.

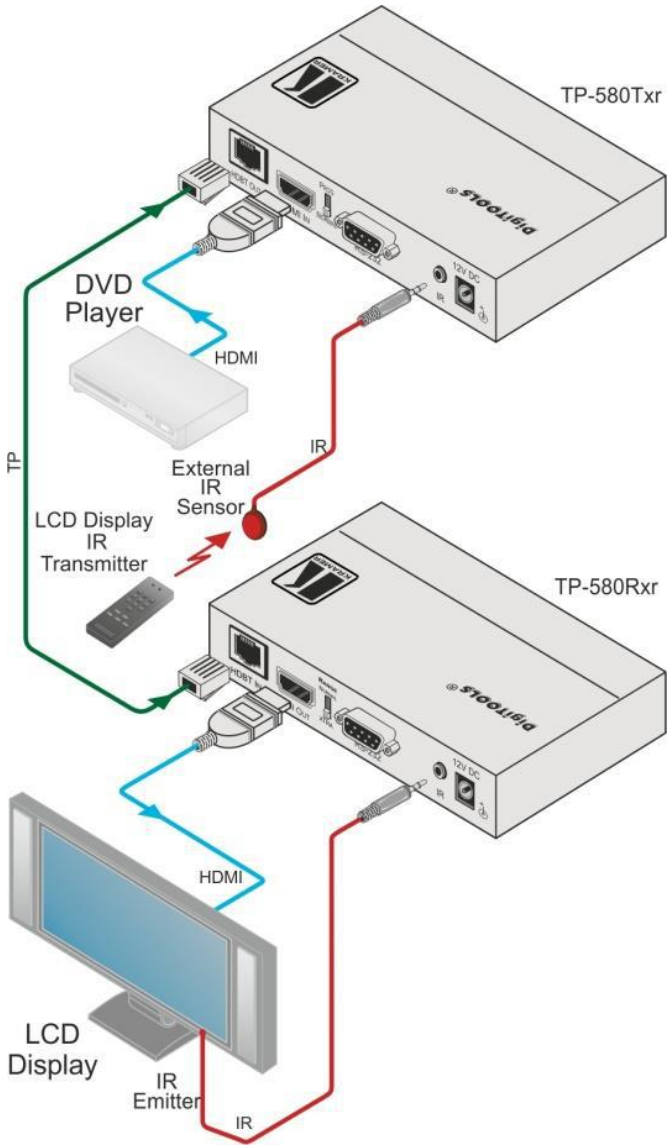

Figure 5: Controlling an LCD Display via the TP-580Txr

6.2 Connecting to a PC

You can connect to the transmitter/receiver system via an RS-232 connection using, for example, a PC. Note that a null-modem adapter/connection is not required.

To connect a PC via RS-232, connect the RS-232 9-pin D-sub rear panel port on the transmitter/receiver system unit via a 9-wire straight cable (only pin 2 to pin 2, pin 3 to pin 3, and pin 5 to pin 5 need to be connected) to the RS-232 9-pin D-sub port on your PC.

[Figure 6](#) shows RS-232 bidirectional control of the projector that is connected to **TP-580Rxr**, via a PC connected to the **TP-580Txr**:

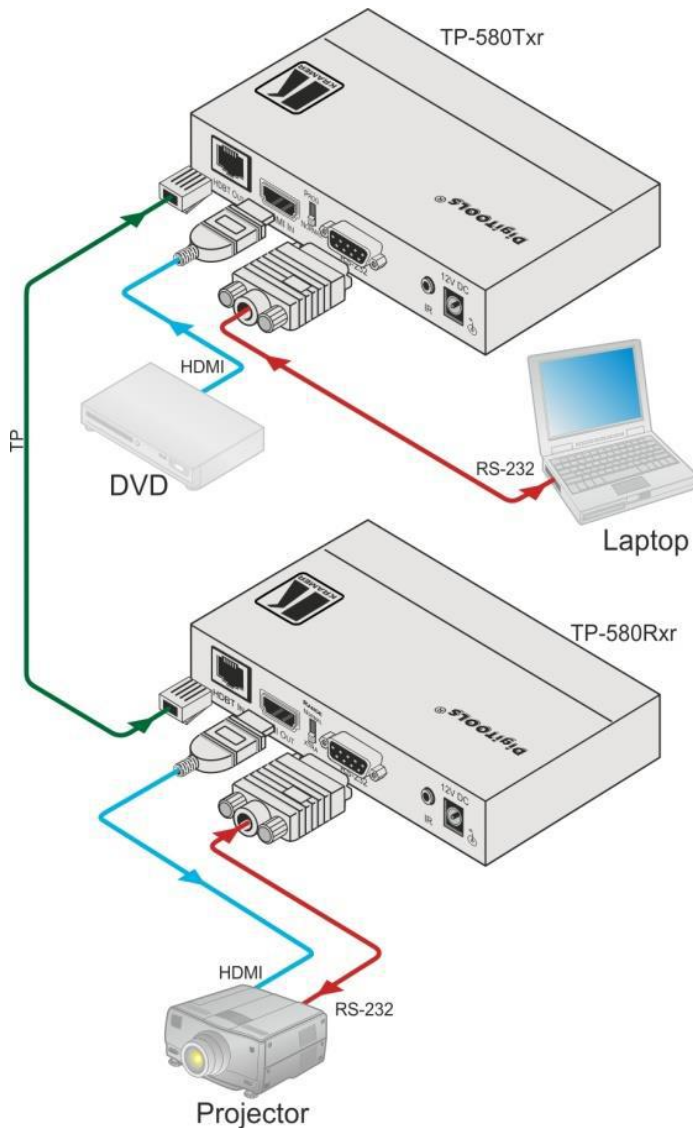

Figure 6: RS-232 Control

6.3 Wiring the TP LINE IN / LINE OUT RJ-45 Connectors

This section defines the TP pinout, using a **straight** pin-to-pin cable with RJ-45 connectors.

EIA /TIA 568B	
PIN	Wire Color
1	Orange / White
2	Orange
3	Green / White
4	Blue
5	Blue / White
6	Green
7	Brown / White
8	Brown

Figure 7: TP PINOUT

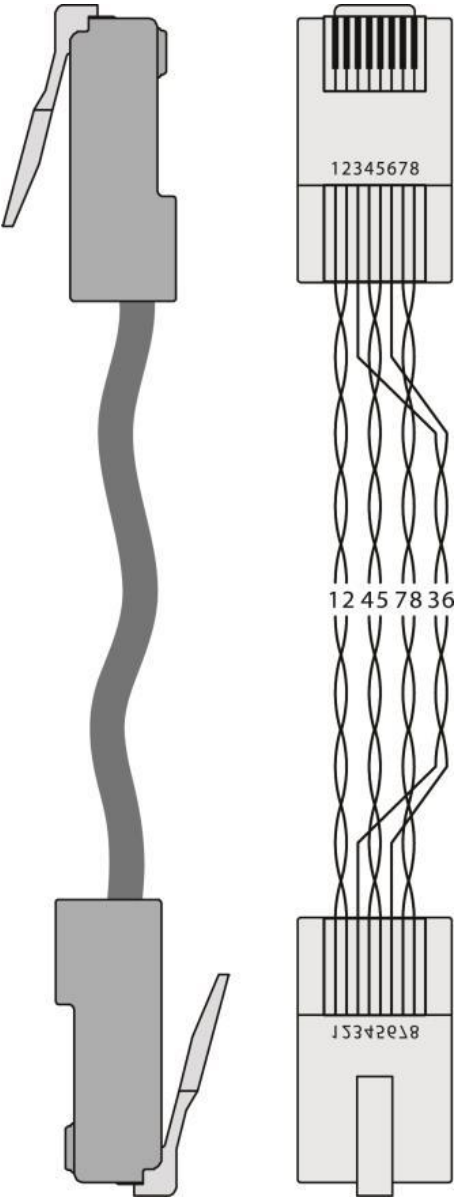

7 Technical Specifications

	TP-580Txr	TP-580Rxr
INPUTS:	1 HDMI connector	1 RJ-45 connector
OUTPUTS:	1 RJ-45 connector	1 HDMI connector
PORTS:	1 IR on a 3.5mm mini jack (for emitter or sensor) 1 RS-232 on a 9-pin D-sub connector	1 IR on a 3.5mm mini jack (for emitter or sensor) 1 RS-232 on a 9-pin D-sub connector
BANDWIDTH:	Supports up to 10.2Gbps (3.4Gbps bandwidth per graphic channel)	
RANGE:	Up to 130m (430ft) at normal mode (2K), up to 100m at normal mode (4K); up to 180m (590ft) ultra mode (1080p @60Hz @24bpp) when using BC-HDKat6a cables	
RS-232 BAUD RATE:	115200	
COMPLIANCE WITH HDMI STANDARD:	Supports HDMI and HDCP	
OPERATING TEMPERATURE:	0° to +40°C (32° to 104°F)	
STORAGE TEMPERATURE:	-40° to +70°C (-40° to 158°F)	
HUMIDITY:	10% to 90%, RHL non-condensing	
POWER SOURCE:	12V DC, 295mA	12V DC, 500mA
DIMENSIONS:	12cm x 7.6 cm x 2.4 cm (4.7" x 3" x 1.0") W, D, H	
WEIGHT:	0.6kg (1.4lbs)	
ACCESSORIES:	Power supply (12V, 0.5A)	Power supply (12V, 1.25A)
OPTIONS:	RK-3T 19" rack mount; Kramer external IR sensor (P/N: 95-0104050), Kramer IR emitter cable (P/N: C-A35/IRE-10), Kramer BC-HDKat6a cable	
Specifications are subject to change without notice Go to our Web site at http://www.kramerav.com to access the list of resolutions		

LIMITED WARRANTY

The warranty obligations of Kramer Electronics for this product are limited to the terms set forth below:

What is Covered

This limited warranty covers defects in materials and workmanship in this product.

What is Not Covered

This limited warranty does not cover any damage, deterioration or malfunction resulting from any alteration, modification, improper or unreasonable use or maintenance, misuse, abuse, accident, neglect, exposure to excess moisture, fire, improper packing and shipping (such claims must be presented to the carrier), lightning, power surges, or other acts of nature. This limited warranty does not cover any damage, deterioration or malfunction resulting from the installation or removal of this product from any installation, any unauthorized tampering with this product, any repairs attempted by anyone unauthorized by Kramer Electronics to make such repairs, or any other cause which does not relate directly to a defect in materials and/or workmanship of this product. This limited warranty does not cover cartons, equipment enclosures, cables or accessories used in conjunction with this product.

Without limiting any other exclusion herein, Kramer Electronics does not warrant that the product covered hereby, including, without limitation, the technology and/or integrated circuit(s) included in the product, will not become obsolete or that such items are or will remain compatible with any other product or technology with which the product may be used.

How Long Does this Coverage Last

Seven years as of this printing; please check our Web site for the most current and accurate warranty information.

Who is Covered

Only the original purchaser of this product is covered under this limited warranty. This limited warranty is not transferable to subsequent purchasers or owners of this product.

What Kramer Electronics will do

Kramer Electronics will, at its sole option, provide one of the following three remedies to whatever extent it shall deem necessary to satisfy a proper claim under this limited warranty:

1. Elect to repair or facilitate the repair of any defective parts within a reasonable period of time, free of any charge for the necessary parts and labor to complete the repair and restore this product to its proper operating condition. Kramer Electronics will also pay the shipping costs necessary to return this product once the repair is complete.
2. Replace this product with a direct replacement or with a similar product deemed by Kramer Electronics to perform substantially the same function as the original product.
3. Issue a refund of the original purchase price less depreciation to be determined based on the age of the product at the time remedy is sought under this limited warranty.

What Kramer Electronics will not do Under This Limited Warranty

If this product is returned to Kramer Electronics or the authorized dealer from which it was purchased or any other party authorized to repair Kramer Electronics products, this product must be insured during shipment, with the insurance and shipping charges prepaid by you. If this product is returned uninsured, you assume all risks of loss or damage during shipment. Kramer Electronics will not be responsible for any costs related to the removal or re-installation of this product from or into any installation. Kramer Electronics will not be responsible for any costs related to any setting up this product, any adjustment of user controls or any programming required for a specific installation of this product.

How to Obtain a Remedy under this Limited Warranty

To obtain a remedy under this limited warranty, you must contact either the authorized Kramer Electronics reseller from whom you purchased this product or the Kramer Electronics office nearest you. For a list of authorized Kramer Electronics resellers and/or Kramer Electronics authorized service providers, please visit our web site at www.kramerelectronics.com or contact the Kramer Electronics office nearest you.

In order to pursue any remedy under this limited warranty, you must possess an original, dated receipt as proof of purchase from an authorized Kramer Electronics reseller. If this product is returned under this limited warranty, a return authorization number, obtained from Kramer Electronics, will be required. You may also be directed to an authorized reseller or a person authorized by Kramer Electronics to repair the product.

If it is decided that this product should be returned directly to Kramer Electronics, this product should be properly packed, preferably in the original carton, for shipping. Cartons not bearing a return authorization number will be refused.

Limitation on Liability

THE MAXIMUM LIABILITY OF KRAMER ELECTRONICS UNDER THIS LIMITED WARRANTY SHALL NOT EXCEED THE ACTUAL PURCHASE PRICE PAID FOR THE PRODUCT. TO THE MAXIMUM EXTENT PERMITTED BY LAW, KRAMER ELECTRONICS IS NOT RESPONSIBLE FOR DIRECT, SPECIAL, INCIDENTAL OR CONSEQUENTIAL DAMAGES RESULTING FROM ANY BREACH OF WARRANTY OR CONDITION, OR UNDER ANY OTHER LEGAL THEORY. Some countries, districts or states do not allow the exclusion or limitation of relief, special, incidental, consequential or indirect damages, or the limitation of liability to specified amounts, so the above limitations or exclusions may not apply to you.

Exclusive Remedy

TO THE MAXIMUM EXTENT PERMITTED BY LAW, THIS LIMITED WARRANTY AND THE REMEDIES SET FORTH ABOVE ARE EXCLUSIVE AND IN LIEU OF ALL OTHER WARRANTIES, REMEDIES AND CONDITIONS, WHETHER ORAL OR WRITTEN, EXPRESS OR IMPLIED. TO THE MAXIMUM EXTENT PERMITTED BY LAW, KRAMER ELECTRONICS SPECIFICALLY DISCLAIMS ANY AND ALL IMPLIED WARRANTIES, INCLUDING, WITHOUT LIMITATION, WARRANTIES OF MERCHANTABILITY AND FITNESS FOR A PARTICULAR PURPOSE. IF KRAMER ELECTRONICS CANNOT LAWFULLY DISCLAIM OR EXCLUDE IMPLIED WARRANTIES UNDER APPLICABLE LAW, THEN ALL IMPLIED WARRANTIES COVERING THIS PRODUCT, INCLUDING WARRANTIES OF MERCHANTABILITY AND FITNESS FOR A PARTICULAR PURPOSE, SHALL APPLY TO THIS PRODUCT AS PROVIDED UNDER APPLICABLE LAW.

IF ANY PRODUCT TO WHICH THIS LIMITED WARRANTY APPLIES IS A "CONSUMER PRODUCT" UNDER THE MAGNUSON-MOSS WARRANTY ACT (15 U.S.C.A. §2301, ET SEQ.) OR OTHER APPLICABLE LAW, THE FOREGOING DISCLAIMER OF IMPLIED WARRANTIES SHALL NOT APPLY TO YOU, AND ALL IMPLIED WARRANTIES ON THIS PRODUCT, INCLUDING WARRANTIES OF MERCHANTABILITY AND FITNESS FOR THE PARTICULAR PURPOSE, SHALL APPLY AS PROVIDED UNDER APPLICABLE LAW.

Other Conditions

This limited warranty gives you specific legal rights, and you may have other rights which vary from country to country or state to state.

This limited warranty is void if (i) the label bearing the serial number of this product has been removed or defaced, (ii) the product is not distributed by Kramer Electronics or (iii) this product is not purchased from an authorized Kramer Electronics reseller. If you are unsure whether a reseller is an authorized Kramer Electronics reseller, please visit our Web site at www.kramerelectronics.com or contact a Kramer Electronics office from the list at the end of this document.

Your rights under this limited warranty are not diminished if you do not complete and return the product registration form or complete and submit the online product registration form. Kramer Electronics thanks you for purchasing a Kramer Electronics product. We hope it will give you years of satisfaction.



For the latest information on our products and a list of Kramer distributors, visit our Web site where updates to this user manual may be found.

We welcome your questions, comments, and feedback.

Web site: <http://www.kramerav.com/>

E-mail: info@kramerel.com



SAFETY WARNING

Disconnect the unit from the power supply before opening and servicing



P/N: 2900-300088



Rev: 5