

**evolution**wireless 

**SR 300 IEM**



# Contents

<b>Important safety instructions</b> .....	2
<b>The evolution wireless series ew 300 IEM G3</b> .....	4
The SR 300 IEM G3 rack-mount transmitter .....	4
The frequency bank system .....	4
<b>Delivery includes</b> .....	5
<b>Product overview</b> .....	6
Overview of the SR 300 IEM G3 transmitter .....	6
Overview of the displays .....	7
<b>Putting the transmitter into operation</b> .....	8
Setting up the transmitter on a flat surface .....	8
Mounting the transmitter into a 19" rack .....	9
Connecting an audio source to the input sockets .....	11
Connecting an audio source to the output sockets .....	11
Daisy chaining audio signals .....	11
Connecting a remote antenna to the BNC socket .....	12
Connecting the AC 3 antenna combiner to the BNC socket .....	12
Connecting transmitters in a network .....	12
Connecting the mains unit .....	13
<b>Using the transmitter</b> .....	14
Switching the transmitter on/off .....	14
Deactivating the lock mode temporarily .....	15
Activating/deactivating the RF signal .....	16
Monitoring the audio signal via headphones .....	16
Synchronizing transmitters and receivers via the infra-red interface .....	16
<b>Using the operating menu</b> .....	19
The buttons .....	19
Overview of the operating menu .....	20
Working with the operating menu .....	22
<b>Adjusting settings via the operating menu</b> .....	24
The main menu "Menu" .....	24
The extended menu "Advanced Menu" .....	28
<b>Synchronizing the transmitter with an EK 300 IEM G3 receiver</b> .....	33
Synchronizing the transmitter with an EK 300 IEM G3 receiver – individual operation .....	33
Synchronizing transmitters with EK 300 IEM G3 receivers – multi-channel operation .....	33
<b>Cleaning the transmitter</b> .....	35
<b>Recommendations and tips</b> .....	35
<b>Accessories and spare parts</b> .....	36
<b>Specifications</b> .....	38
<b>Manufacturer Declarations</b> .....	40
<b>Index</b> .....	41

## Important safety instructions

- Read this instruction manual.
- Keep this instruction manual. Always include this instruction manual when passing the product on to third parties.
- Heed all warnings and follow all instructions in this instruction manual.
- Only clean the product when it is not connected to the mains. Use a cloth for cleaning.
- Never open the product, otherwise you can receive an electric shock. If products are opened by customers in breach of this instruction, the warranty becomes null and void.
- Refer all servicing to qualified service personnel.  
Servicing is required if the product has been damaged in any way, liquid has been spilled, objects have fallen inside, the product has been exposed to rain or moisture, does not operate properly or has been dropped.
- **WARNING:** To reduce the risk of fire or electric shock, do not use the product near water and do not expose it to rain or moisture. Do not place objects filled with liquids, such as vases or coffee cups, on the product.
- Only use the supplied mains unit.
- Unplug the mains unit from the wall socket
  - to completely disconnect the product from the mains,
  - during lightning storms or
  - when unused for long periods of time.
- Only operate the mains unit from the type of power source specified in the chapter "Specifications" (see page 38).
- Ensure that the mains unit is
  - in a safe operating condition and easily accessible,
  - properly plugged into the wall socket,
  - only operated within the permissible temperature range,
  - not covered or exposed to direct sunlight for longer periods of time in order to prevent heat accumulation (see "Specifications" on page 38).
- Do not block any ventilation openings. Install the product and the mains unit in accordance with the instructions given in this instruction manual.
- Do not install the product near any heat sources such as radiators, stoves, or other devices (including amplifiers) that produce heat.
- Only use attachments/accessories specified by Sennheiser.
- Do not overload wall outlets and extension cables as this may result in fire and electric shock.

## Replacement parts

When replacement parts are required, be sure the service technician uses replacement parts specified by Sennheiser or those having the same characteristics as the original part. Unauthorized substitutions may result in fire, electric shock, or other hazards.

## Danger of hearing damage due to high volumes

This product is also intended for professional use. Commercial use is subject to the safety-at-work regulations. Sennheiser, as the manufacturer, is therefore obliged to expressly point out possible health risks arising from use.

This product is capable of producing sound pressure exceeding 85 dB(A). 85 dB(A) is the sound pressure corresponding to the maximum permissible volume which is by law (in some countries) allowed to affect your hearing for the duration of a working day. It is used as a basis according to the specifications of industrial medicine. Higher volumes or longer durations can damage your hearing. At higher volumes, the duration must be shortened in order to prevent hearing damage. The following are sure signs that you have been subjected to excessive noise for too long a time:

- You can hear ringing or whistling sounds in your ears.
- You have the impression (even for a short time only) that you can no longer hear high notes.

## Intended use

Intended use of the product includes:

- having read this instruction manual, especially the chapter "Important safety instructions" on page 2,
- using the product within the operating conditions and limitations described in this instruction manual.

"Improper use" means using the product other than as described in these instructions, or under operating conditions which differ from those described herein.

## The evolution wireless series ew 300 IEM G3

This transmitter is part of the evolution wireless series generation 3 (ew G3). With this series, Sennheiser offers high-quality state-of-the-art RF transmission systems with a high level of operational reliability and ease of use. Transmitters and receivers are designed for monitoring applications and permit wireless transmission with studio-quality sound.

### The SR 300 IEM G3 rack-mount transmitter

With the SR 300 IEM G3 2-channel/stereo monitoring transmitter, musicians, video and sound amateurs, reporters/broadcasters, etc. can directly monitor the received sound signals without troublesome cables or monitor speakers being required. In addition, it can also be used for any application where talkback signals are to be transmitted.

Features of the SR 300 IEM G3 transmitter:

- Optimized PLL synthesizer and microprocessor technology
- Stereo/mono selection
- HDX noise reduction system
- Switching bandwidth of 42 MHz
- Safe configuration of a multi-channel system using the “Wireless Systems Manager” (WSM)
- Easy setup of a multi-channel system using the Easy Setup Sync function

### The frequency bank system

The transmitter is available in 6 UHF frequency ranges with 1,680 transmission frequencies per frequency range:

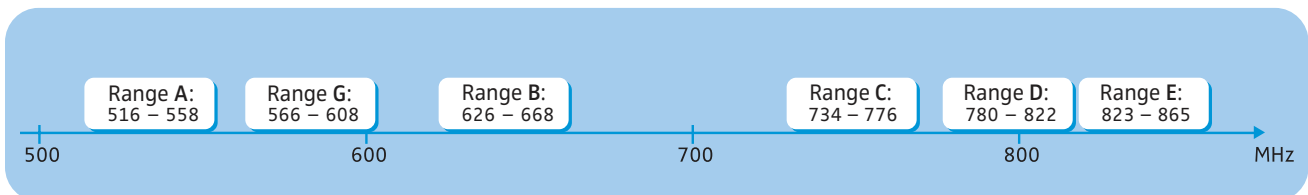

Each frequency range (A–E, G) offers 26 frequency banks with up to 16 channels each:

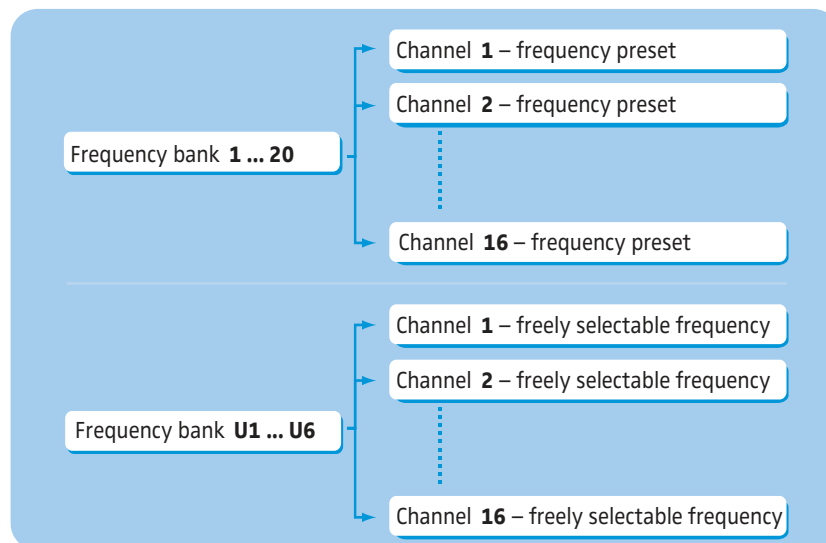

Each of the channels in the frequency banks “1” to “20” has been factory-preset to a fixed transmission frequency (frequency preset). The factory-preset frequencies within one frequency bank are intermodulation-free. These frequencies cannot be changed.

For an overview of the frequency presets, please refer to the supplied frequency information sheet. Updated versions of the frequency information sheet can be downloaded from the corresponding product page on our website at [www.sennheiser.com](http://www.sennheiser.com).

The frequency banks “U1” to “U6” allow you to freely select and store transmission frequencies. It might be that these transmission frequencies are **not** intermodulation-free (see page 34).

## Delivery includes

The packaging contains the following items:

- 1 SR 300 IEM G3 rack-mount transmitter
- 1 NT 2-3 mains unit with one country adapter
- 1 rod antenna
- 1 GA 3 rack adapter
- 1 instruction manual
- 1 frequency information sheet
- 1 RF licensing information sheet
- 4 device feet

# Product overview

## Overview of the SR 300 IEM G3 transmitter

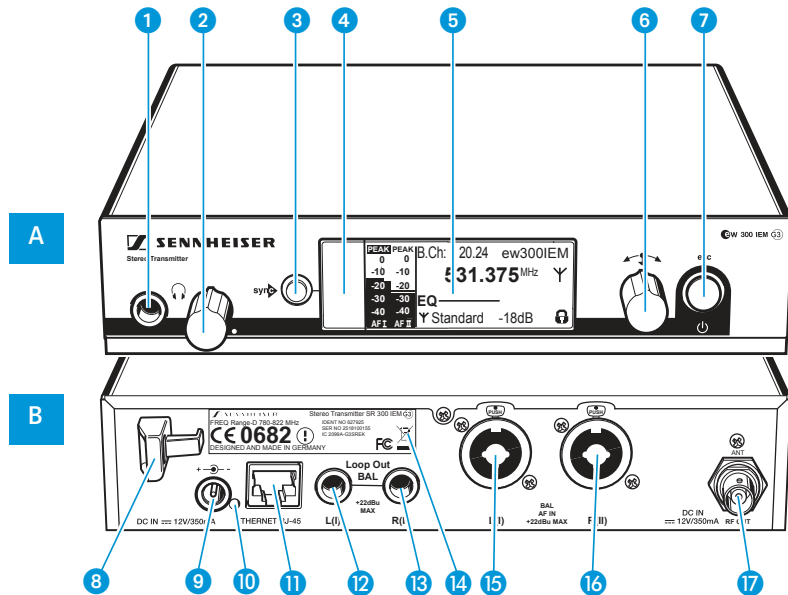

### A Operating elements – front panel

- 1 Headphone output, 1/4" (6.3 mm) jack socket (🎧)
- 2 Headphone volume control
- 3 **sync** button, backlit
- 4 Infra-red interface
- 5 Display panel, backlit in orange
- 6 Jog dial
- 7 STANDBY button ⏻ with operation indication (red backlighting); ESC function (cancel)

### B Operating elements – rear panel

- 8 Cable grip for power supply DC cable of the NT 2-3 mains unit
- 9 DC socket (DC IN) for connection of NT 2-3 mains unit
- 10 LED (yellow) for network activity indication
- 11 LAN socket (ETHERNET RJ 45)
- 12 Audio output left (LOOP OUT BAL L(I)), 1/4" (6.3 mm) jack socket
- 13 Audio output right (LOOP OUT BAL R(II)), 1/4" (6.3 mm) jack socket
- 14 Type plate
- 15 Audio input left (BAL AF IN L(I)), 1/4" (6.3 mm) jack/XLR-3 combo socket\*
- 16 Audio input right (BAL AF IN R(II)), 1/4" (6.3 mm) jack/XLR-3 combo socket
- 17 Antenna output (RF OUT) with remote power supply input, BNC socket

\* During mono operation, the signal from the left audio input (1/4" (6.3 mm) jack/XLR-3 combo socket 15) is transmitted.

## Overview of the displays

After switch-on, the transmitter displays the standard display.

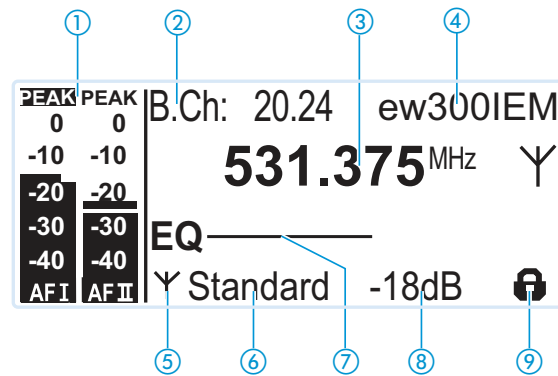

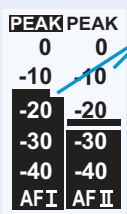
Display	Meaning
<p>① Audio level "AF IN L(I)" and "AF IN R(II)" (AF = Audio Frequency)</p>	 <p>Modulation of the left (I) and right (II) audio channel with peak hold function</p> <p>When the level displays for audio level show full deflection, the audio input level is excessively high. When the transmitter is overmodulated frequently or for extended periods of time, the "PEAK" display is shown inverted.</p>
<p>② Frequency bank and channel</p>	<p>Current frequency bank and channel number</p>
<p>③ Frequency</p>	<p>Current transmission frequency</p>
<p>④ Name</p>	<p>Freely selectable name of the transmitter</p>
<p>⑤ Transmission icon</p>	<p>RF signal is being transmitted</p>
<p>⑥ Transmission power</p>	<p>Current transmission power</p>
<p>⑦ Equalizer setting</p>	<p>Current equalizer setting</p>
<p>⑧ Input sensitivity</p>	<p>Current input sensitivity for the audio signal available at the audio input sockets <b>BAL AF IN L (I)</b> ⑮ and <b>BAL AF IN R (II)</b> ⑯.</p>
<p>⑨ Lock mode icon (see page 15)</p>	<p>Lock mode is activated</p>



## Putting the transmitter into operation



When using more than one transmitter, we recommend connecting remote antennas and, if necessary, using Sennheiser antenna accessories. For more information, visit the ew G3 product page at [www.sennheiser.com](http://www.sennheiser.com).

### Setting up the transmitter on a flat surface

Place the transmitter on a flat, horizontal surface. Please note that the device feet can leave stains on delicate surfaces.



The rack mount "ears" are designed to help protect the operating elements from damage or deformation, e.g. if the transmitter is dropped. Therefore, fasten the rack mount "ears", even if you do not want to rack mount your transmitter.

#### Mounting the rack mount "ears"

To fasten the rack mount "ears" 21:

- ▶ Unscrew and remove the two recessed head screws (M4x8) on each side of the transmitter (see left-hand diagram).
- ▶ Secure the rack mount "ears" 21 to the sides of the transmitter using the previously removed recessed head screws (see right-hand diagram).

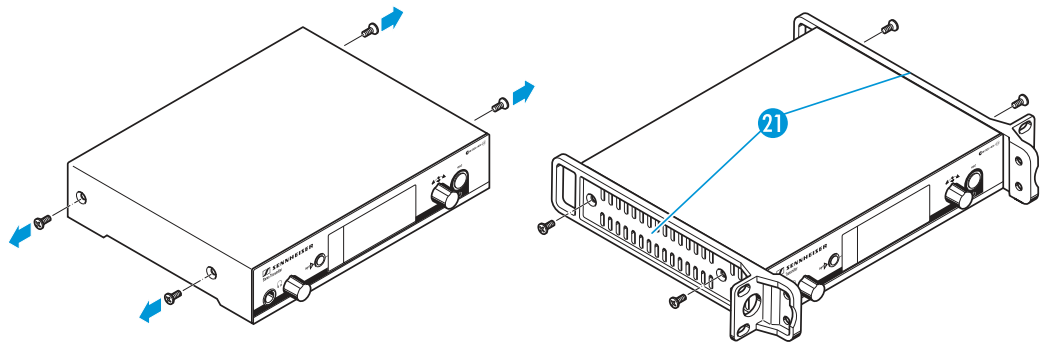

#### Fitting the device feet



Do not fit the device feet when mounting the transmitter into a 19" rack.

- ▶ Clean the base of the transmitter where you want to fix the device feet.
- ▶ Fit the device feet to the four corners of the transmitter.

#### Connecting the rod antenna

The supplied rod antenna 18 is suitable for use in good reception conditions.

- ▶ Connect the rod antenna 18 (see diagram on page 9).

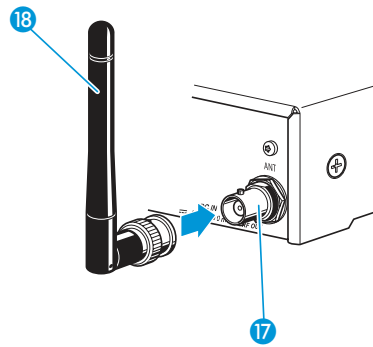

## Mounting the transmitter into a 19" rack



Do not fit the device feet when mounting the transmitter into a 19" rack.

### CAUTION!



#### Risks when rack mounting the transmitter!

When installing the device in a closed or multi-rack assembly, please consider that, during operation, the ambient temperature, the mechanical loading and the electrical potentials will be different from those of devices which are not mounted into a rack.

- ▶ Make sure that the ambient temperature within the rack does not exceed the permissible temperature limit specified in the SR 300 IEM G3 specifications. If necessary, provide additional ventilation.
- ▶ Make sure that the mechanical loading of the rack is even.
- ▶ When connecting to the power supply, observe the information indicated on the type plate. Avoid circuit overloading. If necessary, provide overcurrent protection.
- ▶ When rack mounting, please note that intrinsically harmless leakage currents of the individual mains units may accumulate, thereby exceeding the allowable limit value. As a remedy, ground the rack via an additional ground connection.

#### Rack mounting one transmitter

- ▶ Secure the rack mount "ears" (21) of the supplied GA 3 rack adapter to the transmitter as described on page 8.
- ▶ Secure the blanking plate (22) to one of the rack mount "ears" using two recessed head screws (M 6x10) (see diagram).

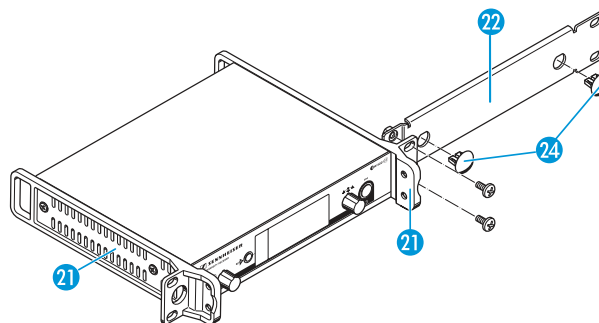

- ▶ Connect the antenna. You have the following options:
  - You can connect the supplied rod antenna 18 to the rear of the transmitter (see page 8). In this case, insert the two blanking plugs 24 into the holes of the blanking plate (see diagram on page 9).
  - You can use the AM 2 antenna front mount kit (see "Accessories and spare parts" on page 36) and mount the rod antenna to the blanking plate 22.
  - You can use a remote antenna, if necessary in conjunction with the AC 3 antenna combiner.
- ▶ Slide the transmitter with the mounted blanking plate 22 into the 19" rack.
- ▶ Secure the rack mount "ear" 21 and the blanking plate 22 to the 19" rack.

### Rack mounting two transmitters

To mount two transmitters into a rack using the GA 3 rack adapter:

- ▶ Place the two transmitters side by side upside-down onto a flat surface.

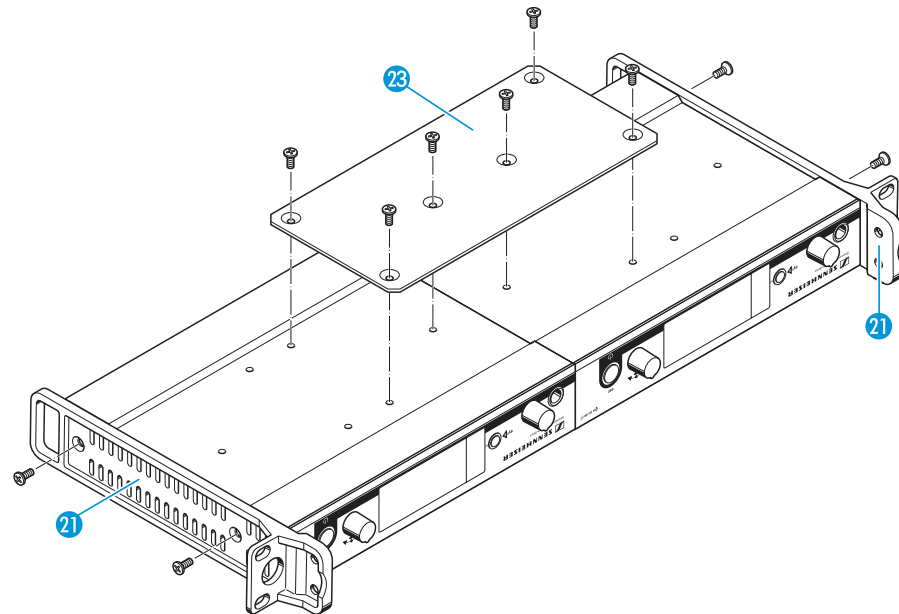

- ▶ Secure the jointing plate 23 to the transmitters using six recessed head screws (M 3x6).
- ▶ Secure the rack mount "ears" 21 to the transmitters as described on page 8.

To mount the transmitters into the rack:

- ▶ Use remote antennas, if necessary in conjunction with the AC 3 antenna combiner. For more information, visit the ew G3 product pages at [www.sennheiser.com](http://www.sennheiser.com).

To mount the transmitters into the rack:

- ▶ Slide the transmitters into the 19" rack.
- ▶ Secure the rack mount "ears" to the 19" rack.

## Connecting an audio source to the input sockets

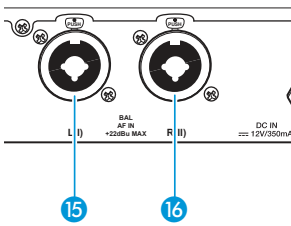

- ▶ Use a suitable cable to connect the output of an audio source (e.g. a mixing console or an additional SR 300 IEM G3) to the input socket **BAL AF IN L(I)** 15 and/or **BAL AF IN R(II)** 16 (see also page 11).
- ▶ Adjust the output level of your external device.
- ▶ Via the operating menu, adjust the transmitter's input sensitivity. The input sensitivity is adjusted via the "Sensitivity" menu item and is common for both inputs (see page 20).



The input amplifier of the SR 300 IEM G3 is designed for line level input.

## Connecting an audio source to the output sockets

- ▶ Use a suitable cable to connect the audio input of an external device (e.g. a mixing console or an additional SR 300 IEM G3) to the output socket **LOOP OUT BAL L(I)** 12 and/or **LOOP OUT BAL R(II)** 13 (see also page 11).



The signal received from the AF input sockets **BAL AF IN L(I)** 15 and **BAL AF IN R(II)** 16 is actively buffered and then routed to the output sockets **LOOP OUT BAL L(I)** 12 and **LOOP OUT BAL R(II)** 13. The AF output sockets will therefore work only when the transmitter is switched on and powered.

## Daisy chaining audio signals

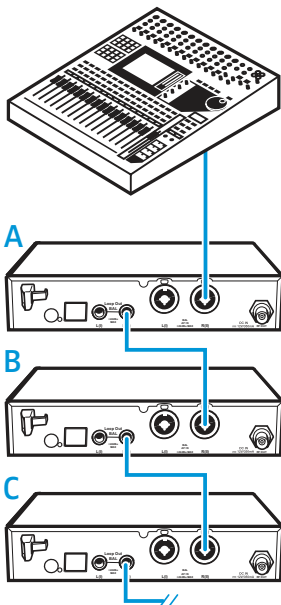

The output sockets **LOOP OUT BAL L** 12 and/or **LOOP OUT BAL R** 13 allow you to daisy chain a signal that is to be transmitted to all receivers from an audio source (e.g. a mixing console) to one transmitter and then to the other transmitters.

To daisy chain an audio signal from one transmitter to the next:

- ▶ Route a signal from the mixing console to the input socket (in this example: **BAL AF IN R** 16) of transmitter A.
- ▶ Connect the output socket **LOOP OUT BAL R** 13 of transmitter A to the input socket **BAL AF IN R** 16 of transmitter B.
- ▶ Connect the output socket **LOOP OUT BAL R** 13 of transmitter B to the input socket **BAL AF IN R** 16 of transmitter C.
- ▶ Repeat for the other transmitters.



The AF output sockets **LOOP OUT BAL L(I)** 12 and/or **LOOP OUT BAL R(II)** 13 will work only when the transmitter is switched on and powered (see page 11).

## Connecting a remote antenna to the BNC socket

Use a remote antenna when the transmitter position is not the best antenna position for optimum transmission. You can choose between two antennas:

- A 2003 UHF passive directional antenna
  - A 1031 passive omni-directional antenna
- ▶ Use a low-attenuation 50-Ω cable to connect the antenna to the transmitter.
  - ▶ If possible, use a short antenna cable and as little connections as possible, since long cables and many connectors lead to an attenuation of the antenna signal.
  - ▶ Position the antenna in the same room in which the transmission takes place.
  - ▶ Observe a minimum distance of 1 m between the antenna and metal objects (including reinforced concrete walls).

## Connecting the AC 3 antenna combiner to the BNC socket

To make multi-channel systems, you should use the AC 3 antenna combiner (see “Accessories and spare parts” on page 36). The AC 3 allows you to operate up to four transmitters with a single antenna without virtually any intermodulation.

In addition, the AC 3 incorporates DC distribution to enable simultaneous powering of up to four transmitters via its BNC sockets.

- ▶ Connect the AC 3 antenna combiner to the BNC socket **17**.

## Connecting transmitters in a network

You can connect several transmitters in a network. The transmitters are remote controlled via a PC running the “Wireless Systems Manager” (WSM) software. This software will assist in the quick and safe configuration of multi-channel systems.



The “Wireless Systems Manager” (WSM) software can be downloaded from our website at [www.sennheiser.com](http://www.sennheiser.com).

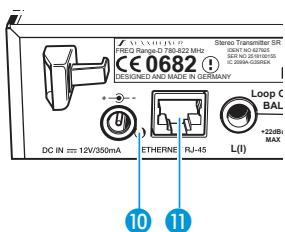

- ▶ Connect a standard network cable (at least Cat 5) to the LAN socket **11** of the transmitter.
  - ▶ Connect your transmitter to an Ethernet switch.
  - ▶ Connect the other transmitters to the Ethernet switch.
  - ▶ Connect a PC to the Ethernet switch.
- When a transmitter is properly connected to the Ethernet switch or the PC, the yellow LED **10** at the rear of the transmitter lights up.



For further information on network operation using the WSM, refer to page 33.

## Connecting the mains unit

Only use the supplied mains unit. It is designed for the transmitter and ensures safe operation.

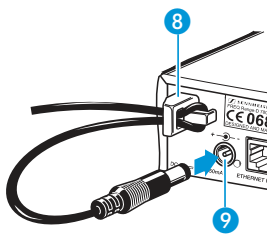

- ▶ Insert the yellow connector of the NT 2-3 mains unit into the yellow socket 9 of the transmitter.
- ▶ Pass the cable of the mains unit through the cable grip 8.
- ▶ Slide the supplied country adapter 20 onto the mains unit 19.
- ▶ Plug the mains unit 19 into a wall socket. The STANDBY button 7 is backlit in red.

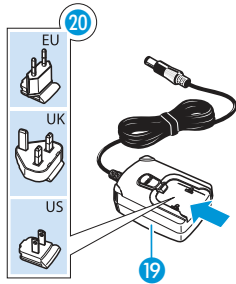

The AC 3 antenna combiner incorporates DC distribution to enable simultaneous powering of up to four transmitters via its BNC sockets. These transmitters do not require their individual power supply (see also page 12).

## Using the transmitter

To establish a transmission link, proceed as follows:

1. Switch the transmitter on (see next section).
2. Switch the receiver on (see the instruction manual of the receiver).  
The transmission link is established.



It is vital to observe the notes on frequency selection on page 33.

---



If you cannot establish a transmission link between transmitter and receiver:

- ▶ Make sure that transmitter and receiver are set to the same frequency bank and to the same channel.
- ▶ If necessary, read the chapter "If a problem occurs ..." on page 37.

## Switching the transmitter on/off

To switch the transmitter **on** (online operation):





- ▶ Briefly press the STANDBY button  7.  
The transmitter switches on and the standard display appears.  
The transmitter transmits an RF signal and the transmission icon  5 is displayed.



You can switch the transmitter on and deactivate the RF signal on switch-on. For more information, refer to page 15.

---

To switch the transmitter to **standby mode**:

- ▶ If necessary, deactivate the lock mode (see page 15).
-  ▶ Keep the STANDBY button  7 pressed until "OFF" appears on the display panel.  
The display panel switches off.



When in the operating menu, pressing the STANDBY button  7 will cancel your entry (ESC function) and return you to the standard display.

The STANDBY button  7 is backlit in red both during operation and in standby mode.

---

To completely switch the transmitter **off**:

- ▶ Disconnect the transmitter from the mains by unplugging the mains unit from the wall socket.  
The backlighting of the STANDBY button  7 goes off.

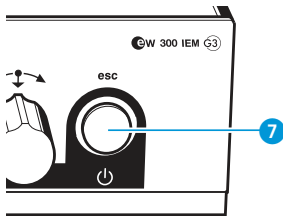

To switch the transmitter on and to **deactivate the RF signal on switch-on** (offline operation):



- ▶ Keep the STANDBY button 7 pressed until “RF Mute On?” appears on the display panel.



- ▶ Press the jog dial.  
The transmission frequency is displayed but the transmitter does not transmit an RF signal. The transmission icon 5 is not displayed. In addition, the display backlighting changes from orange to red and “RF Mute” flashes in alternation with the standard display.



Use this function to prepare a transmitter for use during live operation without causing interference to existing transmission links.

To **activate** the RF signal:



- ▶ Briefly press the STANDBY button 7.  
“RF Mute Off?” appears on the display panel.



- ▶ Press the jog dial.  
The transmission icon 5 is displayed again.

## Deactivating the lock mode temporarily

You can activate or deactivate the automatic lock mode via the “Auto Lock” menu item. If the lock mode is activated, you have to temporarily deactivate it in order to be able to operate the transmitter:



- ▶ Press the jog dial.  
“Locked” appears on the display panel.



- ▶ Turn the jog dial.  
“Unlock?” appears on the display panel.



- ▶ Press the jog dial.  
The lock mode is temporarily deactivated:

### When you are in the operating menu

The lock mode remains deactivated until you exit the operating menu.

### When the standard display is shown

The lock mode is automatically activated after 10 seconds.

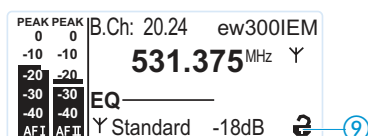

The lock mode icon 9 flashes prior to the lock mode being activated again.







## Activating/deactivating the RF signal

To **deactivate** the RF signal:

- ▶  When the standard display is shown on the display panel, briefly press the STANDBY button.  
"RF Mute On?" appears on the display panel.
- ▶  Press the jog dial.  
The RF signal is deactivated. The transmission icon  is not displayed. In addition, the display backlighting changes from orange to red and "RF Mute" flashes in alternation with the standard display.

To **activate** the RF signal:

- ▶  Press the STANDBY button.  
"RF Mute Off?" appears on the display panel.
- ▶  Press the jog dial.  
The RF signal is activated and the transmission icon  is displayed. The display backlighting changes from red to orange.



You can also deactivate the RF signal on switch-on. For more information, refer to the chapter "Switching the transmitter on/off" on page 14.

## Monitoring the audio signal via headphones

You can monitor the audio signal via the headphone output.

### CAUTION!





#### Danger of hearing damage!

Listening at high volume levels for long periods can lead to permanent hearing defects.

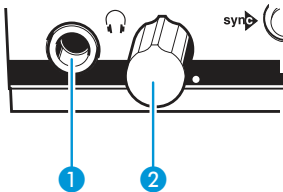
- ▶ Set the headphone volume control  to the minimum position before putting the headphones on.
- ▶ Do **not** continuously expose yourself to high volumes.



- ▶ Set the headphone volume control  to the minimum position.
- ▶ Connect headphones with a 1/4" (6.3 mm) stereo jack plug to the headphone output  .
- ▶ Gradually increase the volume and monitor the audio signal with the lowest possible volume.



## Synchronizing transmitters and receivers via the infra-red interface

### Easy Setup Sync function (EK 300 IEM G3 -> SR 300 IEM G3)

Once you have performed a frequency preset scan with your EK 300 IEM G3 receiver (see the instruction manual of the receiver), you can use the **Easy Setup Sync** function to transfer unused frequency presets from the receiver to several transmitters via the infra-red interface. The receiver transfers the first unused channel from the current frequency bank to the first transmitter and the next unused channel to the second transmitter and so on.

## Sync function (SR 300 IEM G3 -> EK 300 IEM G3)

On the other hand, you can use the **Sync** function to adjust settings for your EK 300 IEM G3 portable receiver directly on your SR 300 IEM G3 rack-mount transmitter and transfer these settings to the receiver via the infra-red interface (see page 30).



When carrying out the **Sync** function, the transmitter's current frequency bank and channel setting is automatically transferred to the receiver via the infra-red interface.

## Carrying out an Easy Setup Sync or a Sync function

The following assumes that you are using the **Easy Setup Sync** function for setting up a multi-channel system. You can also use the **Easy Setup Sync** function for establishing a transmission link between one transmitter and one EK 300 IEM G3 receiver.



Easy Setup Sync	Sync
<ul style="list-style-type: none"> <li>▶ Switch all rack-mount transmitters and one portable receiver on.</li> </ul>	<ul style="list-style-type: none"> <li>▶ Switch your rack-mount transmitter and your portable receiver on.</li> </ul>
<ul style="list-style-type: none"> <li>▶ On all transmitters, call up the "Easy Setup" menu item. The text "Easy Setup Sync" and the <b>sync</b> icon appear on the display panels of the transmitters. The RF signal of the transmitters is automatically deactivated.</li> </ul>	<ul style="list-style-type: none"> <li>▶ Press the <b>sync</b> button <b>3</b> on the transmitter. The <b>sync</b> icon appears on the display panels of the transmitter.</li> </ul>
<ul style="list-style-type: none"> <li>▶ Use your EK 300 IEM G3 portable receiver to perform a frequency preset scan.</li> <li>▶ Select a frequency bank with a sufficient number of unused channels (see the instruction manual of the receiver).</li> </ul>	<p>–</p>
<div data-bbox="496 1312 826 1547" data-label="Image"> </div> <ul style="list-style-type: none"> <li>▶ Place the infra-red interface of the receiver (see the instruction manual of the receiver) in front of the infra-red interface <b>4</b> of the first transmitter. The first unused frequency preset is transferred <b>from the receiver to the transmitter</b>.</li> </ul>	<div data-bbox="1066 1312 1396 1547" data-label="Image"> </div> <ul style="list-style-type: none"> <li>▶ Place the infra-red interface of the receiver (see the instruction manual of the receiver) in front of the infra-red interface <b>4</b> of your transmitter. The parameters adjusted via the "Sync Settings" menu item are transferred <b>from the transmitter to the receiver</b>. In addition, the current frequency bank and channel setting is transferred.</li> </ul>

Easy Setup Sync	Sync
<p>When the transfer is completed, the display panel of the transmitter displays the numbers of the transferred frequency bank and channel.</p> <p>Please note that the transmitter does not automatically store the frequency bank and channel setting.</p>	<p>When the transfer is completed, "✓" appears on the display panel of the transmitter. The transmitter then switches back to the standard display.</p> <p>The transferred parameters are automatically adjusted and stored by the receiver. The transmission link between transmitter and receiver is now established.</p>
<p>▶ Place the infra-red interface of the portable receiver in front of the infra-red interfaces of the remaining transmitters, one after the other.</p> <p>In each case, the next unused frequency preset is transferred <b>from the receiver to the transmitter</b>.</p>	<p>–</p>
<p>▶ Store the frequency bank and channel setting by pressing the jog dial on your transmitters. The RF signal is activated.</p> <p>You can carry out the <b>Sync</b> function (see right-hand column) at a later time to establish a transmission link between transmitters and receivers.</p>	<p>–</p>
<p>OR:</p> <p>▶ Immediately synchronize your receivers with your transmitters by carrying out the <b>Sync</b> function (see right-hand column).</p> <p>This establishes a transmission link between transmitters and receivers.</p> <p>The <b>sync</b> icon in the left lower corner of the transmitter display indicates that the <b>Sync</b> function can be carried out.</p>	
<p>–</p>	<p>To cancel the transfer:</p> <p>▶ Press the STANDBY button  7 on the transmitter.</p> <p>"X" appears on the display panel of the transmitter. "X" also appears if no suitable receiver was found.</p>

## Using the operating menu

A special feature of the Sennheiser ew G3 series is the consistent, intuitive menu structure of transmitters and receivers. As a result, adjustments to the settings can be made quickly – even in stressful situations, for example on stage or during a live show or presentation.

### The buttons

Button	Function of the button
Press the STANDBY button 	<ul style="list-style-type: none"> <li>• Switches the transmitter on and off</li> <li>• Cancels the entry and returns to the standard display (ESC function)</li> <li>• Activates/deactivates the RF signal (special function, see page 16)</li> </ul>
Press the jog dial 	<ul style="list-style-type: none"> <li>• Changes from the standard display to the operating menu</li> <li>• Calls up a menu item</li> <li>• Enters a submenu</li> <li>• Stores the settings and returns to the operating menu</li> </ul>
Turn the jog dial 	<ul style="list-style-type: none"> <li>• Changes to the next/previous menu item</li> <li>• Changes the setting of a menu item</li> </ul>

## Overview of the operating menu

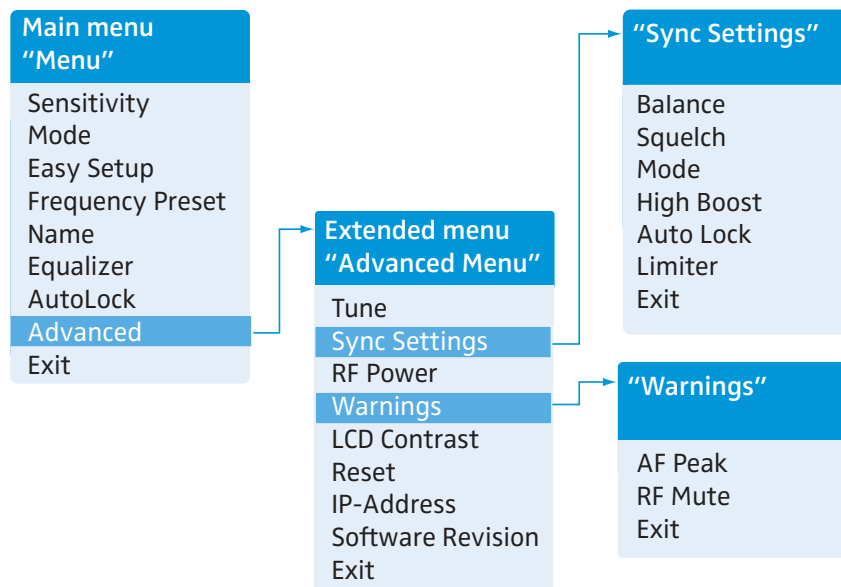

When the standard display is shown on the display panel, you can get into the main menu by pressing the jog dial. The extended menu “Advanced Menu” and the other menus can be accessed via the corresponding menu items.

Display	Function of the menu item	Page
<b>Main menu “Menu”</b>		24
Sensitivity	Adjusts the input sensitivity (0 to –42 dB in steps of 3 dB)	24
Mode	Selects mono or stereo operation	25
Easy Setup	Deactivates the RF signal and activates the Easy Setup Sync function (see page 16)	
Frequency Preset	Sets the frequency bank and the channel	26
Name	Enters a freely selectable name	26
Equalizer	Changes the frequency response of the output signal using a graphic equalizer (+/– 12 dB in steps of 2.4 dB)	27
AutoLock	Activates/deactivates the automatic lock mode	28
Advanced	Calls up the extended menu “Advanced Menu”	28
Exit	Exits the operating menu and returns to the standard display	
<b>Extended menu “Advanced Menu”</b>		
Tune	Sets the transmission frequencies for the frequency banks “U1” to “U6”	28
	Sets the frequency bank, the channel and the transmission frequency (frequency banks “U1” to “U6”)	29
Sync Settings	Adjusts the receiver parameters and activates/deactivates their transfer to the receivers	30

Display	Function of the menu item	Page
RF Power	Adjusts the transmission power (“Low” or “Standard”)	31
Warnings	Calls up “Warnings” (see below)	31
LCD Contrast	Adjusts the contrast of the display panel (adjustable in 16 steps)	31
Reset	Resets the settings made in the operating menu	31
IP-Address	Adjusts the IP address of the transmitter	32
Software Revision	Displays the current software revision	32
Exit	Exits the extended menu “Advanced Menu” and returns to the main menu	

### “Sync Settings”

Balance, Squelch, Mode, High Boost, Auto Lock, Limiter	For a detailed overview of the settings, refer to page 30.	30
Exit	Exits “Sync Settings” and returns to the extended menu “Advanced Menu”	

### “Warnings”

Activates/deactivates warnings (color change and warning messages)

AF Peak	Audio overmodulation	31
RF Mute	RF signal is deactivated	
Exit	Exits “Warnings” and returns to the extended menu “Advanced Menu”	

## Working with the operating menu



If the lock mode is activated, you have to deactivate it in order to be able to work with the operating menu (see page 15).

By way of example of the "Frequency Preset" menu, this section describes how to use the operating menu.

### Changing from the standard display to the operating menu



- ▶ Press the jog dial. The standard display is replaced by the main menu. The last selected menu item is displayed.

Menu
Sensitivity
Mode
Easy Setup
<b>Frequency Preset</b>
Name
Equalizer
Auto Lock
Advanced
Exit

### Selecting a menu item



- ▶ Turn the jog dial to change to the "Frequency Preset" menu item. The current setting of the selected menu item is displayed:

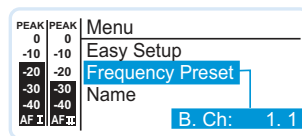

### Changing and storing settings

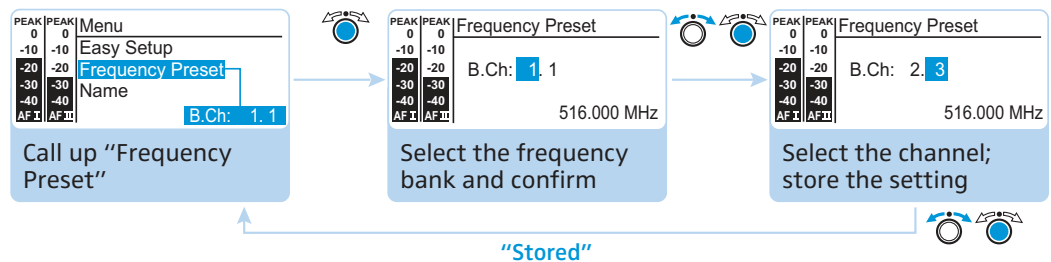

- ▶ Press the jog dial to call up the menu item.



- ▶ Turn the jog dial to set the frequency bank.



- ▶ Press the jog dial to confirm your selection.



- ▶ Turn the jog dial to set the channel.



- ▶ Press the jog dial to store the setting.



By briefly turning the jog dial to the left or right, the display jumps either forwards or backwards to the next menu item or setting. If you turn the jog dial to the left or right and hold it in this position, the display cycles continuously ("fast search" function).

### Canceling an entry



- ▶  Press the STANDBY button to cancel the entry. The standard display appears on the display panel.

To subsequently return to the last edited menu item:

- ▶  Press the jog dial repeatedly until the last edited menu item appears.

Menu
Sensitivity
Mode
Easy Setup
Frequency Preset
Name
Equalizer
Auto Lock
Advanced
Exit

### Exiting a menu item

- ▶  Change to the "Exit" menu item.
- ▶  Confirm your selection. You return to the next higher menu level or you exit the operating menu and return to the standard display.

To directly return to the standard display:

- ▶  Press the STANDBY button.



# Adjusting settings via the operating menu

## The main menu "Menu"

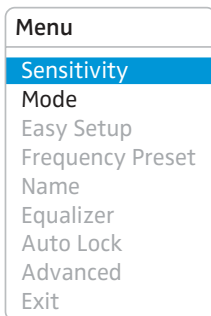

### Adjusting the input sensitivity – "Sensitivity"

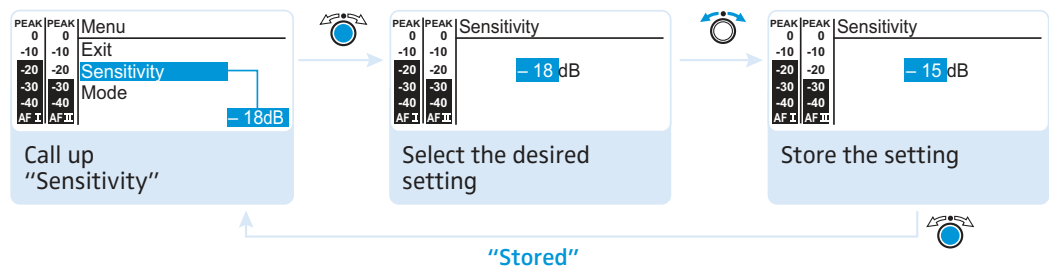

Adjustment range: 0 to -48 dB, adjustable in steps of 3 dB

Via the "Sensitivity" menu item, you can adjust the transmitter's input sensitivity to the output signal of the audio source. The adjusted input sensitivity is common for both audio inputs of the transmitter.



The audio level display "AF" always indicates the audio level, even if the transmitter is muted, e.g. allowing you to check the adjusted sensitivity before live operation.

Input sensitivity is adjusted ...	Effect/display
... too high	Close talking distances, speakers with loud voices or loud music passages cause overmodulation in the transmission link. The audio level display "AF I" and/or "AF II" ① shows full deflection for the duration of the overmodulation.
... correctly	The audio level display "AF I" and/or "AF II" ① shows full deflection only during the loudest passages.
... too low	The transmission link is undermodulated. This results in a signal with high background noise.

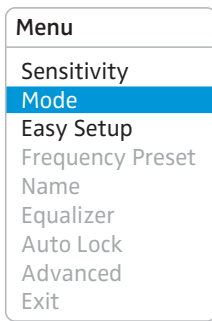

### Selecting mono or stereo operation – “Mode”

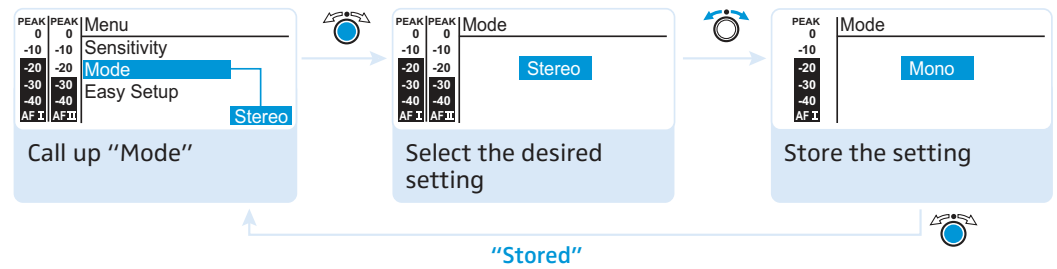

- ▶ Select **"Stereo"** if you want to transmit the audio signals from the left and right audio input (BAL AF IN L (I) 15 and BAL AF IN R (II) 16).
- ▶ Select **"Mono"** if you only want to transmit the audio signal from the left audio input BAL AF IN L (I) 15.



During mono operation, you have to deactivate the pilot tone evaluation on your EK 300 IEM G3 receiver in order to ensure that the receiver outputs the same signal on channel I and II.

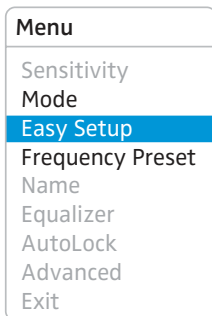

### Starting synchronization – “Easy Setup”

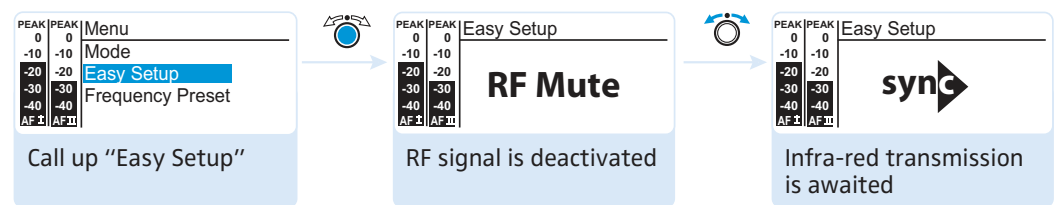

- ▶ Call up **"Easy Setup"** to transfer an unused frequency preset from the EK 300 IEM G3 receiver to the transmitter via the infra-red interface (see page 16). The RF signal of the transmitter is automatically deactivated (**"RF Mute"** flashes) and the transmitter awaits the data transfer.

If you do not want to start the transfer or to cancel the transfer:



- ▶ Press the STANDBY button.



For a detailed description of the **Easy Setup** function, refer to the chapter "Synchronizing transmitters and receivers via the infra-red interface" on page 16.

Menu
Sensitivity
Mode
Easy Setup
Frequency Preset
Name
Equalizer
Auto Lock
Advanced
Exit

### Selecting the frequency bank and the channel manually – “Frequency Preset”

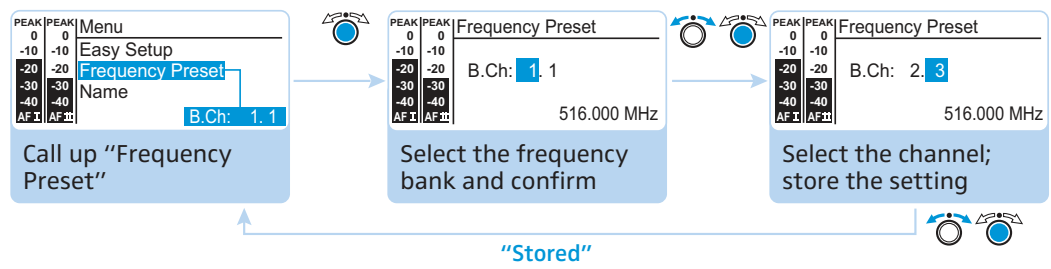

When you are in the “Frequency Preset” menu item, the RF signal is deactivated.

Overview of the frequency banks and channels:

Frequency bank	Channels	Type
“1” to “20”	up to 16 per frequency bank	System bank: frequencies are factory-preset
“U1” to “U6”	up to 16 per frequency bank	User bank: frequencies are freely selectable (see page 28)



When setting up multi-channel systems, please observe the following:

Only the factory-preset frequencies within one frequency bank (“1” to “20”) are intermodulation-free. It is vital to observe the notes on frequency selection on page 33.

Menu
Sensitivity
Mode
Easy Setup
Frequency Preset
Name
Equalizer
Auto Lock
Advanced
Exit

### Entering a name – “Name”

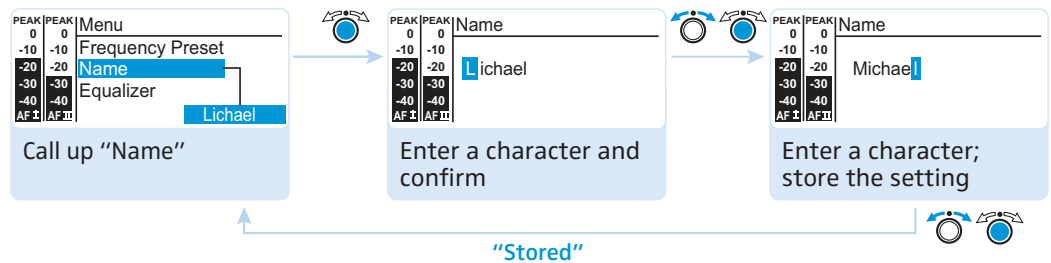

Via the “Name” menu item, you can enter a freely selectable name (e.g. the name of the performer) for the transmitter. The name is displayed on the standard display. The name can consist of up to 8 characters such as:

- letters (without pronunciation marks),
- numbers from 0 to 9,
- special characters and spaces.

To enter a name, proceed as follows:



▶ Turn the jog dial to select a character.



▶ Press the jog dial to change to the next segment/character or to store the complete entry.

Menu
Sensitivity
Mode
Easy Setup
Frequency Preset
Name
<b>Equalizer</b>
Auto Lock
Advanced
Exit

### Using the equalizer

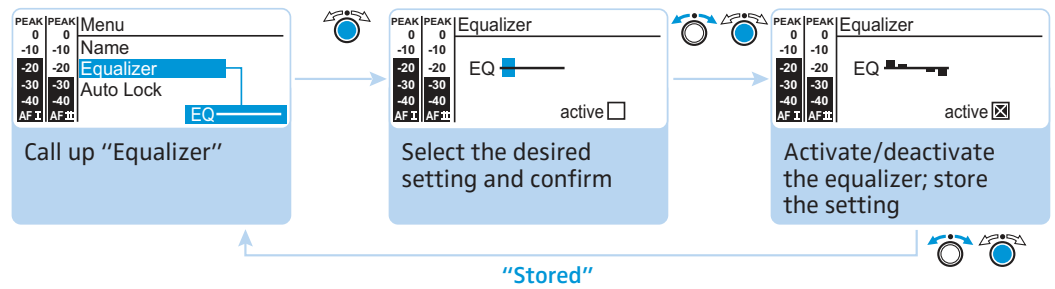

Adjustment range: +/- 12 dB, adjustable in steps of 2.4 dB

You can change the treble and bass of the audio output signal in 5 frequency ranges.

Display	Frequency range
	20 to 100 Hz
	100 to 300 Hz
	300 Hz to 1 kHz
	1 to 3 kHz
	3 to 10 kHz

To change the treble and bass of the audio output signal, proceed as follows:

- ▶ Turn the jog dial to boost or cut the frequency range.
- ▶ Press the jog dial to change to the next frequency range or to store the complete entry.

Menu
Sensitivity
Mode
Easy Setup
Frequency Preset
Name
Equalizer
<b>Auto Lock</b>
Advanced
Exit

### Activating/deactivating the automatic lock mode – “Auto Lock”

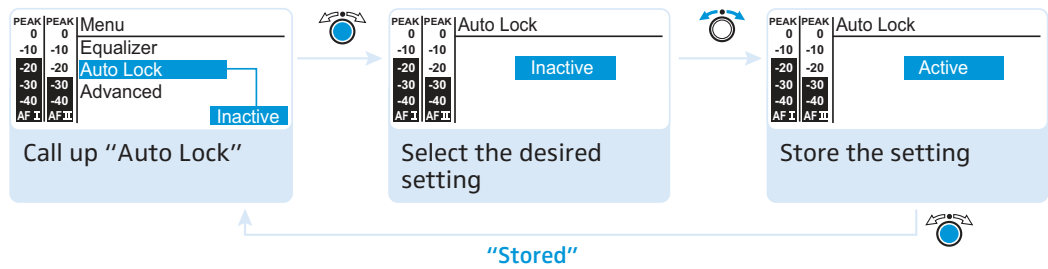

The lock mode prevents that the transmitter is accidentally switched off or programmed during operation. The lock mode icon  on the standard display indicates that the lock mode is activated. For information on how to use the lock mode, refer to page 15.

 ▶ Turn the jog dial to select the desired setting.

### The extended menu “Advanced Menu”

Advanced Menu
<b>Tune</b>
Sync Settings
RF Power
Warnings
LCD Contrast
Reset
IP-Address
Software Revision
Exit

#### Setting the transmission frequencies and the frequency banks “U1” to “U6” – “Tune”



When you have selected one of the system banks and then select the “Tune” menu, the transmitter automatically switches to channel 1 of the frequency bank “U1”. In this case, “U1.1” briefly appears on the display panel.

Upon delivery, the channels of the frequency banks “U1” to “U6” are not assigned a transmission frequency.

When you are in the “Tune” menu item, the RF signal is deactivated.



Via the “Tune” menu item, you can:

1. set a transmission frequency to be stored in the current channel of the selected frequency bank (“U1” to “U6”)
 

or
2. select a frequency bank (“U1” to “U6”) and a channel and assign this channel a transmission frequency.

Advanced Menu
<b>Tune</b>
Sync Settings
RF Power
Warnings
LCD Contrast
Reset
IP-Address
Software Revision
Exit

#### Setting a transmission frequency for the current channel

-  ▶ Turn the jog dial until the “Tune” menu item appears.
-  ▶ Press the jog dial.  
The frequency selection appears.

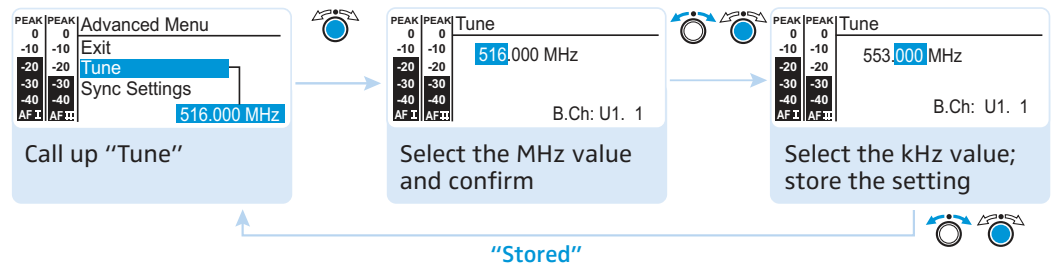

- ▶ Set the desired frequency.
- ▶ Press the jog dial.  
Your settings are stored. You are back to the operating menu.



It is vital to observe the notes on frequency selection on page 33.

Advanced Menu
Tune
Sync Settings
RF Power
Warnings
LCD Contrast
Reset
IP-Address
Software Revision
Exit

### Selecting a frequency bank and a channel and assigning this channel a transmission frequency

- ▶ Turn the jog dial until the "Tune" menu item appears.
- ▶ Keep the jog dial pressed until the frequency bank selection appears.

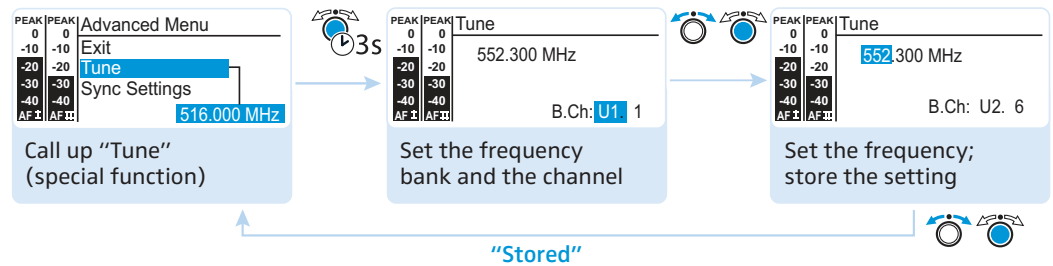

- ▶ Set the desired frequency bank.
- ▶ Press the jog dial.  
The channel selection appears.
- ▶ Set the desired channel.
- ▶ Press the jog dial.  
The frequency selection appears.
- ▶ Set the desired frequency (MHz and kHz values).
- ▶ Press the jog dial.  
Your settings are stored. You are back to the operating menu.

Advanced Menu
Tune
<b>Sync Settings</b>
RF Power
Warnings
LCD Contrast
Reset
IP-Address
Software Revision
Exit

## Adjusting the receiver parameters and activating/deactivating their transfer to the receiver – “Sync Settings”

Via the “Sync Settings” submenu, you can adjust the following parameters for the EK 300 IEM receiver:

Menu item	Transferred receiver parameter
Balance	Balance or Focus setting (“-15”/“+15”)
Squelch	Squelch setting (“5 dB” ... “25 dB”)
Mode	Audio mode setting (“Stereo”/“Focus”)
High boost	Treble boost setting for output signal (“flat”/“High boost” (8 dB at 10 kHz))
Auto Lock	Lock mode setting (“active”/“inactive”)
Limiter	Limiter setting (“-18 dB”, “-12 dB”, “-6 dB”, “Off”)

You can specify for each parameter whether it is to be transferred to the receiver during synchronization.

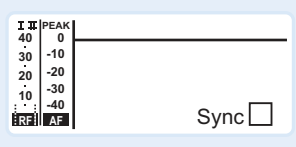
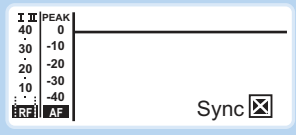
Parameter	Transfer is ...
	... deactivated
	... activated

By pressing the **sync**  **3** button on the transmitter, the parameters are transferred from the transmitter to the receiver (see page 16).

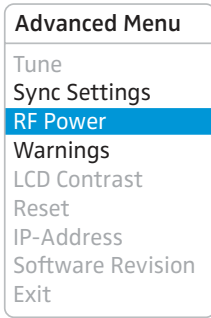

### Adjusting the transmission power – “RF Power”

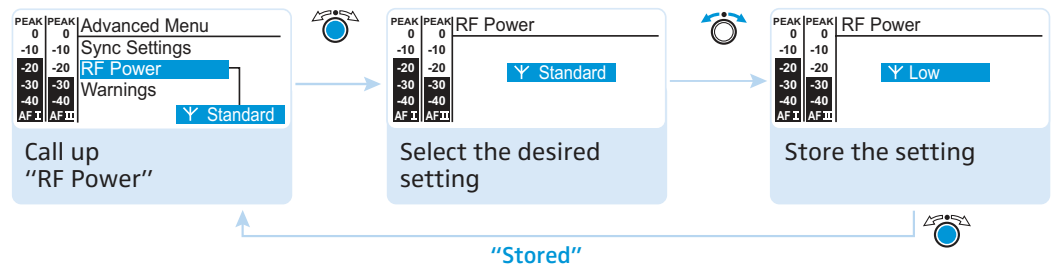

Via the “RF Power” menu item, you can adjust the transmission power in two steps (Low, Standard).



It is vital to observe the notes on the enclosed frequency information sheet!

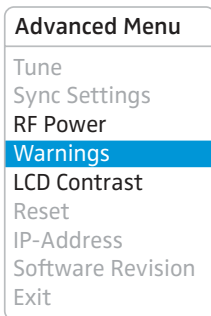

### Activating/deactivating warning messages – “Warnings”

Via the “Warnings” menu item, you can activate or deactivate different warning messages.

Setting	Warning message*	Trigger
AF Peak	“AF Peak”	Audio overmodulation
RF Mute	“RF Mute”	RF signal is deactivated (see page 16)

\* with color change on the standard display

### Adjusting the contrast of the display panel – “LCD Contrast”

You can adjust the contrast of the display panel in 16 steps.

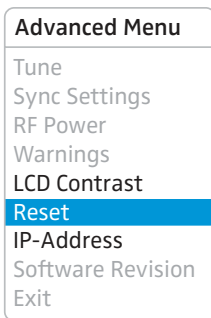

### Resetting the settings made in the operating menu – “Reset”

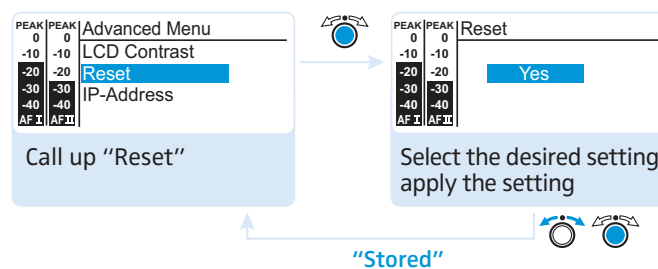

When resetting the settings made in the operating menu, only the selected settings for the pilot tone and for the frequency banks “U1” to “U6” remain unchanged. For an overview of the factory-preset default settings, refer to the enclosed frequency information sheet.



Advanced Menu	
Tune	
Sync Settings	
RF Power	
Warnings	
LCD Contrast	
Reset	
<b>IP-Address</b>	
Software Revision	
Exit	

### Adjusting the network configuration – “IP Address”

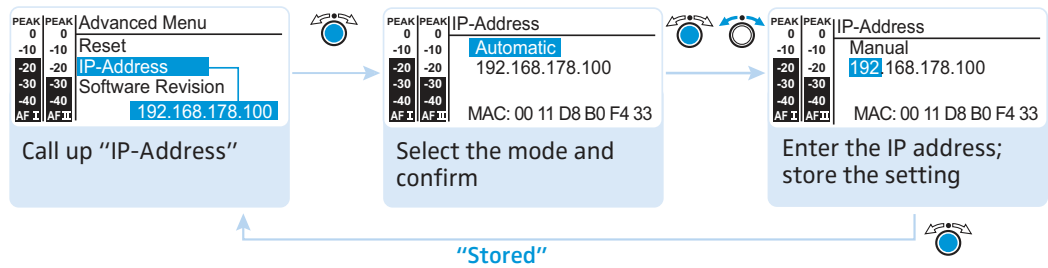

You can either automatically allocate or manually enter an IP address. This menu item also shows the transmitter’s unique and unchangeable MAC address. In order to ensure safe communication between transmitters in multi-channel systems (see page 33), we recommend using automatic allocation of IP addresses.

### Displaying the software revision – “Software Revision”

You can display the current software revision of the transmitter.

- ▶ For information on software updates, visit the SR 300 IEM G3 product page on our website at [www.sennheiser.com](http://www.sennheiser.com).

## Synchronizing the transmitter with an EK 300 IEM G3 receiver

When synchronizing your transmitter with a receiver, please observe the following:



- ▶ Only use a transmitter and a receiver from the same frequency range (see the type plates on the transmitter and the receiver).
- ▶ Make sure that the desired frequencies are listed in the enclosed frequency information sheet.
- ▶ Make sure that the desired frequencies are approved and legal in your country and, if necessary, apply for an operating license.

### Synchronizing the transmitter with an EK 300 IEM G3 receiver – individual operation

Upon delivery, transmitter and receiver are synchronized with each other. If, however, you cannot establish a transmission link between transmitter and receiver, you have to synchronize the channels of the devices:

- ▶ Carry out the [Easy Setup Sync](#) function and then the [Sync](#) function (see page 17). This establishes a transmission link between the transmitter and the receiver.

Alternatively, you can set the channel on the transmitter manually:

- ▶ Make sure that you set the transmitter to the same frequency bank and the same channel as the receiver.

### Synchronizing transmitters with EK 300 IEM G3 receivers – multi-channel operation

#### Network operation using the WSM

In multi-channel operation, the transmitters are remote controlled via a PC running the [“Wireless Systems Manager”](#) (WSM) software.

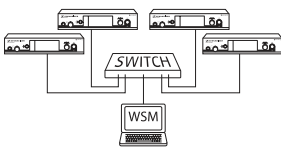

Advantages of controlling the transmitters via the [“Wireless Systems Manager”](#) (WSM) software

- Detailed overview of all transmission and receiving channels
- Remote control of all transmitters in the network
- Combination of transmitters of different frequency ranges (see page 4)

- ▶ Connect your transmitters and your PC in a network (see page 12).
- ▶ Switch your transmitters and your PC on.
- ▶ Launch the [“Wireless Systems Manager”](#) (WSM) software.
- ▶ To set up your multi-channel system, proceed as described in the instruction manual of the [“Wireless Systems Manager”](#) (WSM) software.

### Operation without network

- ▶ Carry out the **Easy Setup Sync** function and then, for each transmitter/receiver pair, the **Sync** function (see page 17).  
This establishes a transmission link between the transmitter and the receiver.

### Using freely selectable transmission frequencies

You can also freely select the frequencies and store these frequencies in the frequency banks "U1" to "U6".

If you want to use the frequency banks "U1" to "U6":

- ▶ Make sure to use transmitters and receivers from the same frequency range (see page 4 and the type plates of the devices).
- ▶ Only use frequencies that are approved and legal in your country (see page 33).



To ensure that the desired frequencies are intermodulation-free:

- ▶ Contact your Sennheiser partner (see [www.sennheiser.com](http://www.sennheiser.com)).
- 

- ▶ Set each transmitter to the same frequency bank.
  - ▶ On one of the transmitters, select a channel within this frequency bank (see page 20).
  - ▶ Assign this channel one of the calculated transmission frequencies (see page 20).
  - ▶ Synchronize a receiver with your transmitter (**sync**, see page 17).
- OR
- ▶ Manually set the receiver to the same frequency bank, channel and frequency that you set on the transmitter.
  - ▶ Repeat for the remaining transmitters and receivers as described above.

## Cleaning the transmitter

**CAUTION!**

Liquids can damage the electronics of the transmitter!

Liquids entering the housing of the transmitter can cause a short-circuit and damage the electronics.

- ▶ Keep all liquids away from the transmitter.
- ▶ Before cleaning, disconnect the transmitter from the mains.
- ▶ Use a cloth to clean the transmitter from time to time. Do not use any solvents or cleansing agents.

## Recommendations and tips

### ... for optimum reception

- Transmission range depends to a large extent on location and can vary from about 10 m to about 150 m. There should be a "free line of sight" between transmitting and receiving antennas.
- To avoid overloading the receiver, observe a minimum distance of 5 m between transmitting and receiving antennas.

### ... for multi-channel operation

- Each of the frequency banks "1" to "20" accommodates factory-preset receiving frequencies which are intermodulation-free. For possible frequency combinations, please refer to the supplied frequency information sheet.
- The channels in the frequency banks "U1" to "U6" can be assigned freely selectable frequencies (see page 34).
- When using several transmitters simultaneously, interference can be avoided by maintaining a minimum distance of 20 cm between two transmitters.
- Use accessories recommended by Sennheiser for multi-channel applications (see page 36).

## Accessories and spare parts

**Cat. No.** **Accessory/spare part**

- 532711** Stacking elements, 1 pair
- 503167** GA 3 rack adapter
- 009912** AM 2 antenna front mount kit (for GA 3 rack adapter)
- 503157** NT 2-3 EU: Mains unit for powering the SR 300 IEM G3; EU version
- 503870** NT 2-3 US: Mains unit for powering the SR 300 IEM G3; US version
- 503871** NT 2-3 UK: Mains unit for powering the SR 300 IEM G3; UK version
- 503159** NT 3-1 EU: Table top power supply for powering the AC 3 and four transmitters; EU version
- 503876** NT 3-1 US: Table top power supply for powering the AC 3 and four transmitters; US version
- 503877** NT 3-1 UK: Table top power supply for powering the AC 3 and four transmitters; UK version
- 503166** AC 3 antenna combiner
- 528212** A 5000 CP circularly polarized broadband antenna
- 003658** A 2003 directional broadband antenna
- 004645** A 1031 omni-directional broadband antenna
- 087969** Antenna daisy-chain cable, 50  $\Omega$ , BNC, 0.25 m
- 002324** GZL 1019-A1 coaxial cable, type RG 58, BNC to BNC, 1 m

## If a problem occurs ...

Problem	Possible cause	Possible solution
Transmitter cannot be operated, "Locked" appears on the display panel	Lock mode is activated	Deactivate the lock mode (see page 15 and page 20).
No operation indication	No mains connection	Check the connections of the mains unit.
No RF signal at the receiver	Transmitter and receiver are not on the same channel	Set the transmitter and receiver to the same channel. To do so, use the synchronization function (see page 16).
	If "RF Mute" additionally appears on the transmitter display: RF signal is deactivated	Activate the RF signal (see page 16).
Very weak RF signal at the receiver	Transmission range is exceeded	Reduce the distance between receiver and transmitter.
		Reposition the antennas.
		Increase the transmission power (see page 21).
		Check the squelch threshold setting on the receiver.
RF signal available, no audio signal at the receiver	No input signal at the transmitter	Check the audio level on the transmitter display (see page 7).
	Very low input signal	Check the audio level on the transmitter display (see page 7), increase the level of the input signal or adjust the input sensitivity (see page 20).
Audio signal has a high level of background noise	Transmitter sensitivity is adjusted too low	Adjust the transmitter sensitivity correctly.
Audio signal is distorted	If "AF PEAK" additionally appears on the transmitter display: transmitter sensitivity is adjusted too high	Adjust the transmitter sensitivity correctly.
	Receiver's audio output level is adjusted too high	Reduce the audio output level (see the instruction manual of the receiver).

If a problem occurs that is not listed in the above table or if the problem cannot be solved with the proposed solutions, please contact your local Sennheiser partner for assistance. To find a Sennheiser partner in your country, search at [www.sennheiser.com](http://www.sennheiser.com) under "Service & Support".

# Specifications

## RF characteristics

Frequency ranges	516–558, 566–608, 626–668, 734–776, 780–822, 823–865 MHz (A to E, G, see page 4)
Transmission frequencies	1,680 frequencies, tuneable in steps of 25 kHz 20 frequency banks, each with up to 16 factory-preset channels 6 frequency banks with up to 16 user programmable channels
Switching bandwidth	42 MHz
Frequency stability	±10 ppm (–10°C to +55°C)
Antenna output	BNC socket, 50 Ω
RF output power at 50 Ω	typ. 10/30 mW (Low/Standard), switchable

## AF characteristics

Modulation	wideband FM stereo (MPX pilot tone)
Comander system	Sennheiser HDX
Nominal/peak deviation	±24 kHz/±48 kHz
MPX pilot tone (frequency/deviation)	19 kHz/±5 kHz
AF frequency response	25 Hz to 15 kHz
AF input <a href="#">BAL AF IN L (I)</a> / <a href="#">BAL AF IN R (II)</a>	2 x XLR-3/¼" (6.3 mm) jack combo socket, electronically balanced
Max. input level	+22 dBu
THD (at 1 kHz and nominal deviation)	< 0.9 %
Signal-to-noise ratio at nominal load and peak deviation	> 90 dB
AF output <a href="#">LOOP OUT BAL L (I)</a> / <a href="#">LOOP OUT BAL R (II)</a>	¼" (6.3 mm) stereo jack socket, balanced

## Overall device

Temperature range	–10 °C to +55 °C
Power supply	12 V ===
Current consumption	max. 350 mA
Dimensions	approx. 202 mm x 212 mm x 43 mm
Weight	approx. 980 g

## In compliance with

Europa	EMC	EN 301489-1/-9
	Radio	EN 300422-1/-2
	Safety	EN 60065

### Approved by

Canada	Industry Canada RSS 123, IC: 2099A-G3SREK limited to 806 MHz
USA	FCC-Part 74 FCC-ID: DMOG3SREK limited to 698 MHz

### NT 2-3 mains unit



Input voltage	100 to 240 V~, 50/60 Hz
Current consumption	max. 120 mA
Output voltage	12 V ===
Secondary output current	400 mA
Temperature range	-10 °C to +40 °C

### In compliance with

Europe	 EMC EN 55022, EN 55024, EN 55014-1/-2 Safety EN 60065
USA	 47 CFR 15 subpart B
Canada	ICES 003

The mains unit is certified in accordance with the legal safety requirements of Europe, the United States, Canada, Russia and Japan.

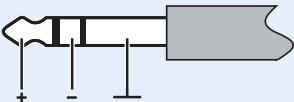
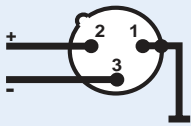
### Connector assignment

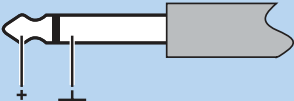
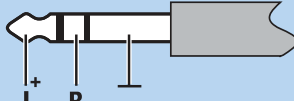
Audio		Other connectors
1/4" (6.3 mm) stereo jack plug, balanced (Audio In/Loop out) 	XLR-3F connector, balanced (Audio In) 	DC connector for power supply 
1/4" (6.3 mm) mono jack plug, unbalanced 	1/4" (6.3 mm) stereo jack plug for headphone output 	



# Manufacturer Declarations

## Warranty

Sennheiser electronic GmbH & Co. KG gives a warranty of 24 months on this product.

For the current warranty conditions, please visit our website at [www.sennheiser.com](http://www.sennheiser.com) or contact your Sennheiser partner.

## In compliance with the following requirements

- RoHS Directive (2002/95/EC)
- WEEE Directive (2002/96/EC)



Please dispose of the transmitter at the end of its operational lifetime by taking it to your local collection point or recycling center for such equipment.

## CE Declaration of Conformity

- **CE 0682** ⓘ
- R&TTE Directive (1999/5/EC), EMC Directive (2004/108/EC), Low Voltage Directive (2006/95/EC)  
The declarations are available at [www.sennheiser.com](http://www.sennheiser.com).  
Before putting the device into operation, please observe the respective country-specific regulations.

## Statements regarding FCC and Industry Canada

This device complies with Part 15 of the FCC Rules and with RSS-210 of Industry Canada. Operation is subject to the following two conditions: (1) this device may not cause harmful interference, and (2) this device must accept any interference received, including interference that may cause undesired operation.

This equipment has been tested and found to comply with the limits for a Class B digital device, pursuant to Part 15 of the FCC Rules. These limits are designed to provide reasonable protection against harmful interference in a residential installation. This equipment generates, uses and can radiate radio frequency energy and, if not installed and used in accordance with the instructions, may cause harmful interference to radio communications. However, there is no guarantee that interference will not occur in a particular installation. If this equipment does cause harmful interference to radio or television reception, which can be determined by turning the equipment off and on, the user is encouraged to try to correct the interference by one or more of the following measures:

- Reorient or relocate the receiving antenna.
- Increase the separation between the equipment and receiver.
- Connect the equipment into an outlet on a circuit different from that to which the receiver is connected.
- Consult the dealer or an experienced radio/TV technician for help.

This class B digital device complies with the Canadian ICES-003.

Changes or modifications made to this equipment not expressly approved by Sennheiser electronic Corp. may void the FCC authorization to operate this equipment.

Before putting the device into operation, please observe the respective country-specific regulations!

# Index

## activating/deactivating

- AF Peak (warning message) 31
- lock mode (Auto Lock) 28
- RF Mute (warning message) 31
- warning messages (Warnings) 31

## adjusting

- contrast (LCD Contrast) 31
- input sensitivity (Sensitivity) 24
- network configuration (IP Address) 32
- receiver parameters (Sync Settings) 30
- transmission power (RF Power) 31

## Advanced Menu (extended menu)

- overview 20
- settings 28

## antenna

- connecting a remote antenna 12
- connecting the AC 3 antenna combiner 12
- connecting the rod antenna to the front 10
- connecting the rod antenna to the rear 8

## antenna front mount kit 10

## audio signal

- connecting to input 11
- daisy chaining 11
- monitoring 16

## audio source

- connecting 11
- daisy chaining 11

## Auto Lock (activating/deactivating the lock mode) 28

## buttons

- function 19
- using 19

## channel

- assigning a frequency 29
- display 7
- overview 4
- selecting (Frequency Preset) 26
- selecting (Tune) 28

## connecting

- antenna 8
- mains unit 13
- transmitters in a network 12

## device feet, fitting 8

## displays

- adjusting the contrast of the display panel (LCD Contrast) 31
- AF (audio level) 7
- equalizer setting 7
- frequency 7
- frequency bank and channel 7
- input sensitivity 7
- lock mode icon 7
- name of the transmitter 7
- overview 7
- PEAK (overmodulation) 7
- transmission icon 7
- transmission power 7

## Easy Setup Sync 16, 17

## equalizer

- display of equalizer setting 7
- settings 27

## extended menu (Advanced Menu)

- overview 20
- settings 28

## factory default settings (resetting the settings made in the operating menu) 31

## frequency

- ~ ranges 4
- display 7
- preset frequencies 4
- selecting ~ presets 26
- setting a transmission frequency 28
- using freely selectable transmission frequencies 34

## frequency bank

- ~ system 4
- display 7
- overview 4
- selecting (Frequency Preset) 26

## Frequency Preset (selecting a frequency bank/channel) 26

## infra-red transmission 16

## IP-Address (adjusting the network configuration) 32

## LCD Contrast (contrast of the display panel) 31

- lock mode**
  - activating/deactivating (Auto Lock) 28
  - deactivating temporarily 15
- Locked (lock mode activated) 15**
- main menu (Menu)**
  - overview 20
  - settings 24
- mains unit, connecting 13**
- Menu (main menu)**
  - overview 20
  - settings 24
- mixing console, connecting 11**
- Mode (mono/stereo selection) 25**
- modulation (input sensitivity/adjusting the sensitivity) 24**
- mono operation 6, 25**
- Name (entering a name) 26**
- network**
  - adjusting the network configuration (IP Address) 32
  - setting up 12
- offline operation (RF signal deactivated) 15**
- online operation (RF signal activated) 14**
- operating menu**
  - overview 20
  - using 22
- receiver settings**
  - activating/deactivating the infra-red transmission (Sync Settings) 30
  - adjusting (Sync Settings) 30
- receiver, synchronizing with transmitter 16**
- Reset (resetting the settings made in the operating menu) 31**
- RF Mute (warning message) 15, 16, 21**
- RF Mute Off (activating the RF signal) 15, 16**
- RF Mute On (deactivating the RF signal) 16**
- RF Power (adjusting the transmission power) 31**
- selecting**
  - channel (Frequency Preset) 26
  - frequency bank (Frequency Preset) 26
  - frequency bank (Tune) 28
  - mono or stereo operation (Mode) 25
- Sensitivity (adjusting the input sensitivity) 24**
- Software Revision (displaying the software revision) 32**
- standby 14**
- stereo operation 25**
- switching on/off 14**
- Sync 17**
- Sync Settings (adjusting transferable receiver settings) 30**
- synchronizing (transmitter/receiver) 16**
- transmission frequency**
  - selecting (Frequency Preset) 26, 28
  - setting (Tune) 28
- transmission power, optimizing 35**
- transmitter**
  - cleaning 35
  - connecting in a network 12
  - fitting the device feet 8
  - mounting into a 19" rack 9
  - setting up on a flat surface 8
  - switching on/off 14
  - switching to standby 14
  - synchronizing with receiver 16
  - using 14
- troubleshooting 37**
- Tune (setting the transmission frequencies and frequency banks) 28**
- Unlock (deactivating the lock mode) 15**
- using**
  - buttons 19
  - equalizer 27
  - operating menu 22
- warning messages (Warnings)**
  - activating/deactivating 31
  - overview 21
- Warnings (warning messages)**
  - activating/deactivating 31
  - overview 21
- WSM (Wireless Systems Manager) 12**

Sennheiser electronic GmbH & Co. KG  
Am Labor 1, 30900 Wedemark, Germany  
[www.sennheiser.com](http://www.sennheiser.com)

Printed in Germany  
Publ. 01/09  
529680/A01